



US00D787934S

(12) **United States Design Patent**
Bore

(10) **Patent No.:** **US D787,934 S**

(45) **Date of Patent:** **** May 30, 2017**

(54) **FOLDING BOX**

(71) Applicant: **Henkel AG & Co. KGaA**, Duesseldorf (DE)

(72) Inventor: **Olivier Bore**, Parmain (FR)

(73) Assignee: **Henkel AG & Co. KGaA** (DE)

(**) Term: **15 Years**

(21) Appl. No.: **29/527,007**

(22) Filed: **May 14, 2015**

(30) **Foreign Application Priority Data**

Nov. 17, 2014 (EM) 002579250

(51) **LOC (10) Cl.** **09-03**

(52) **U.S. Cl.**
USPC **D9/433**

(58) **Field of Classification Search**
USPC D9/430, 414, 432, 524, 516, 433, 431;
D7/543, 545, 602, 552.2, 538, 550.1;
229/112, 100

CPC B65D 1/00; B65D 5/4291; B65D 5/38;
B65D 1/225; B65D 5/002; B65D 5/603;
A47F 5/11

See application file for complete search history.

(56) **References Cited**

U.S. PATENT DOCUMENTS

D339,438 S * 9/1993 Moran D34/1
D596,027 S * 7/2009 Kalberer D9/432

D616,300 S * 5/2010 Shaikh D9/430
D637,487 S * 5/2011 Franic D9/433
D649,451 S * 11/2011 Franic D9/433
D657,239 S * 4/2012 Gavrilencov D9/432
D670,163 S * 11/2012 Lauritzen D9/431
D682,684 S * 5/2013 Walter D9/434
D691,471 S * 10/2013 Walter D9/434
D708,514 S * 7/2014 Kiamilev D9/432
D728,364 S * 5/2015 Baker D9/432
D740,656 S * 10/2015 Stewart D9/432
D748,470 S * 2/2016 Mohn D9/432

* cited by examiner

Primary Examiner — Cynthia Underwood

(74) *Attorney, Agent, or Firm* — David K. Benson

(57) **CLAIM**

The ornamental design for a folding box, as shown and described.

DESCRIPTION

FIG. 1 is a front perspective view of a folding box embodying my new design;
FIG. 2 is a front side elevation view thereof;
FIG. 3 is a rear side elevation view thereof;
FIG. 4 is a right side elevation view thereof;
FIG. 5 is a left side elevation view thereof;
FIG. 6 is a top plan view thereof;
FIG. 7 is a bottom plan view thereof; and,
FIG. 8 is a top plan view of the folding box in an unfolded state.

1 Claim, 7 Drawing Sheets

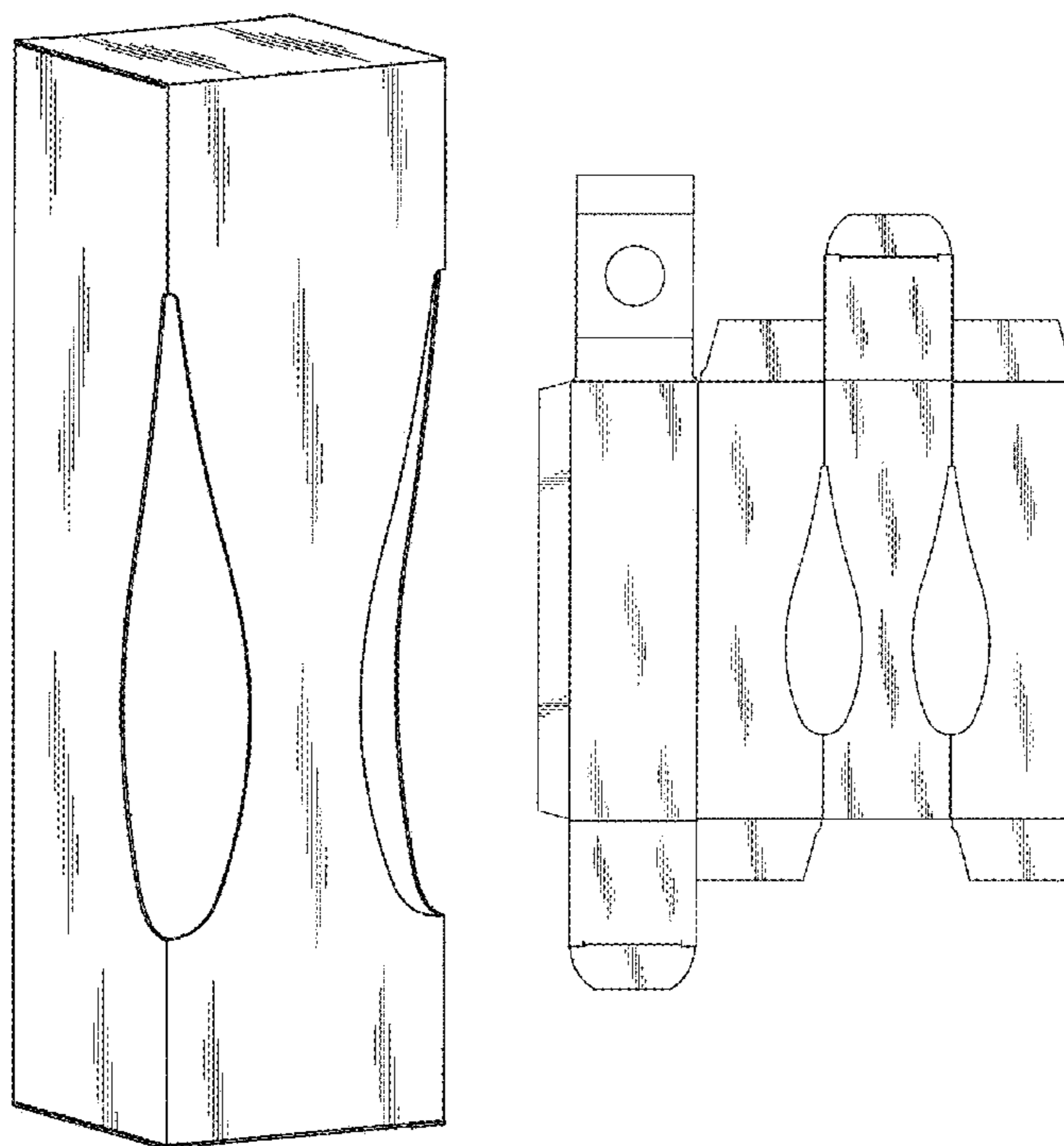

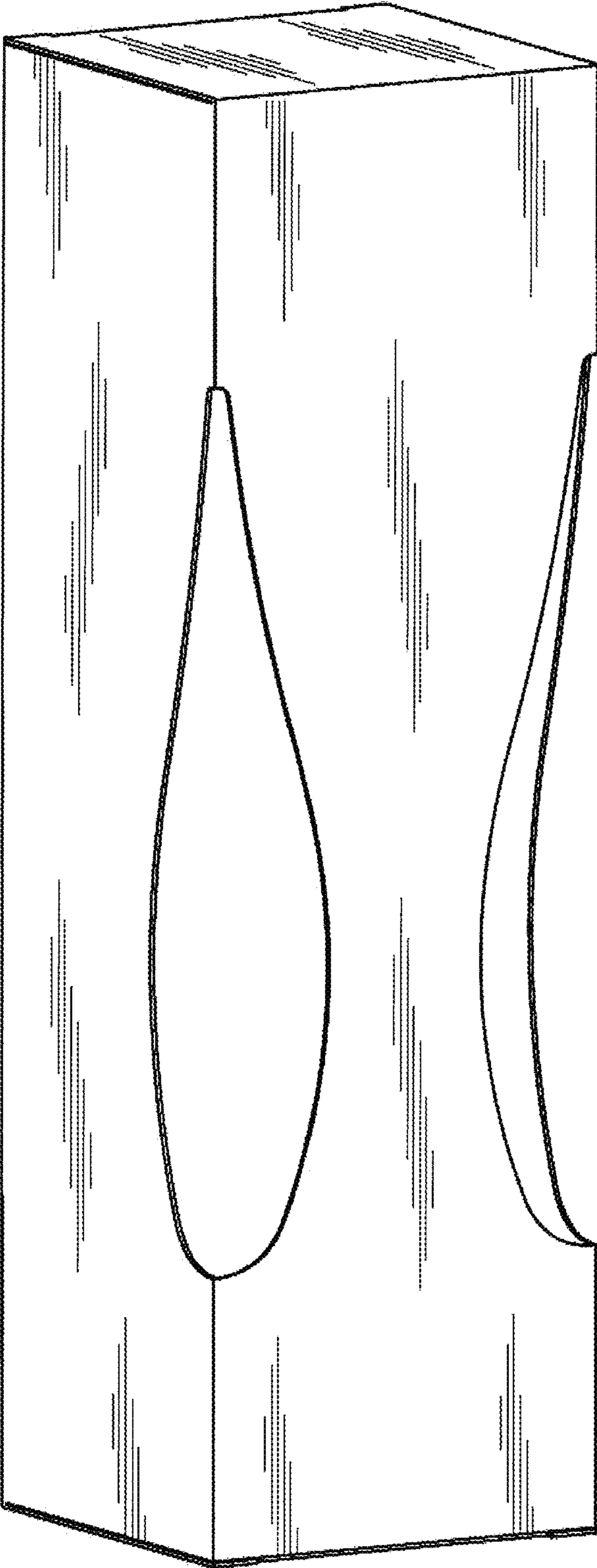

FIG. 1

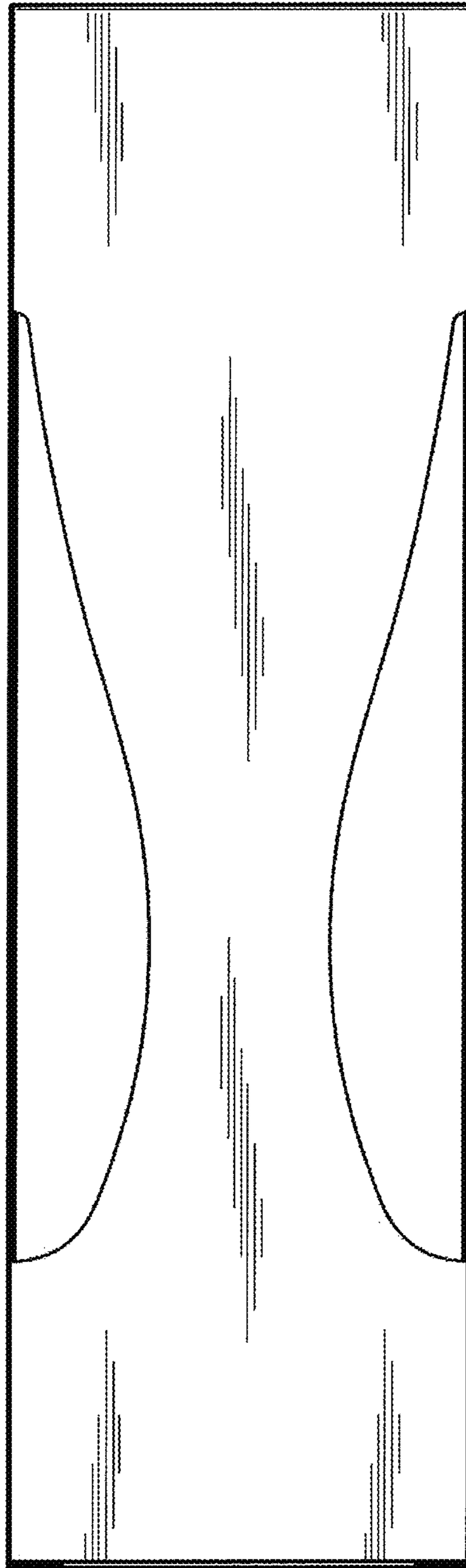

FIG. 2

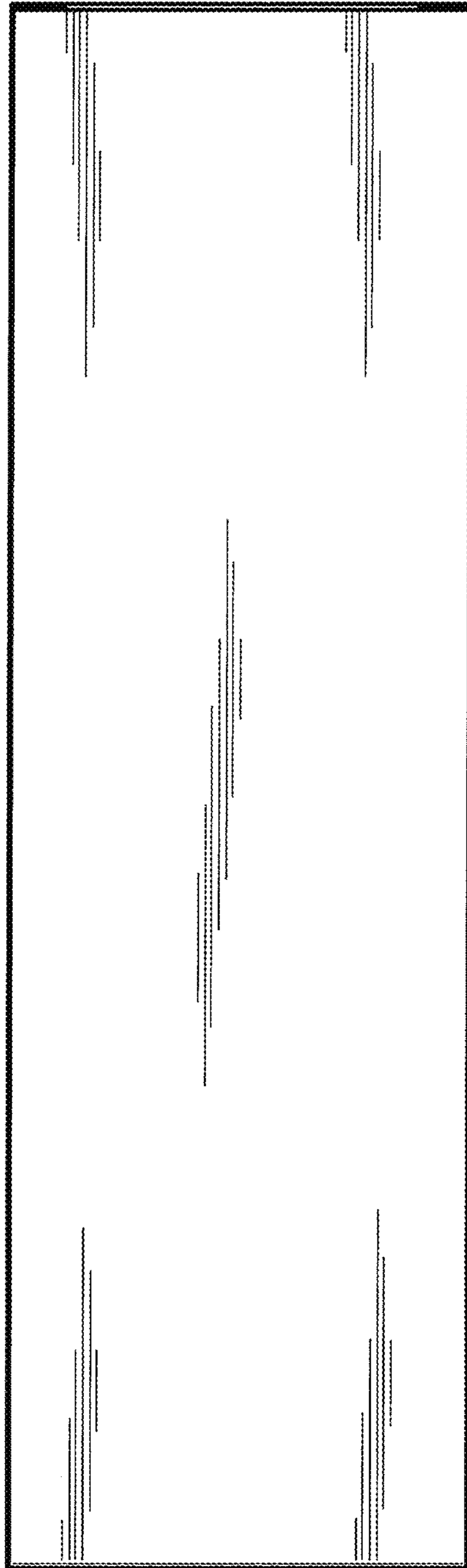

FIG. 3

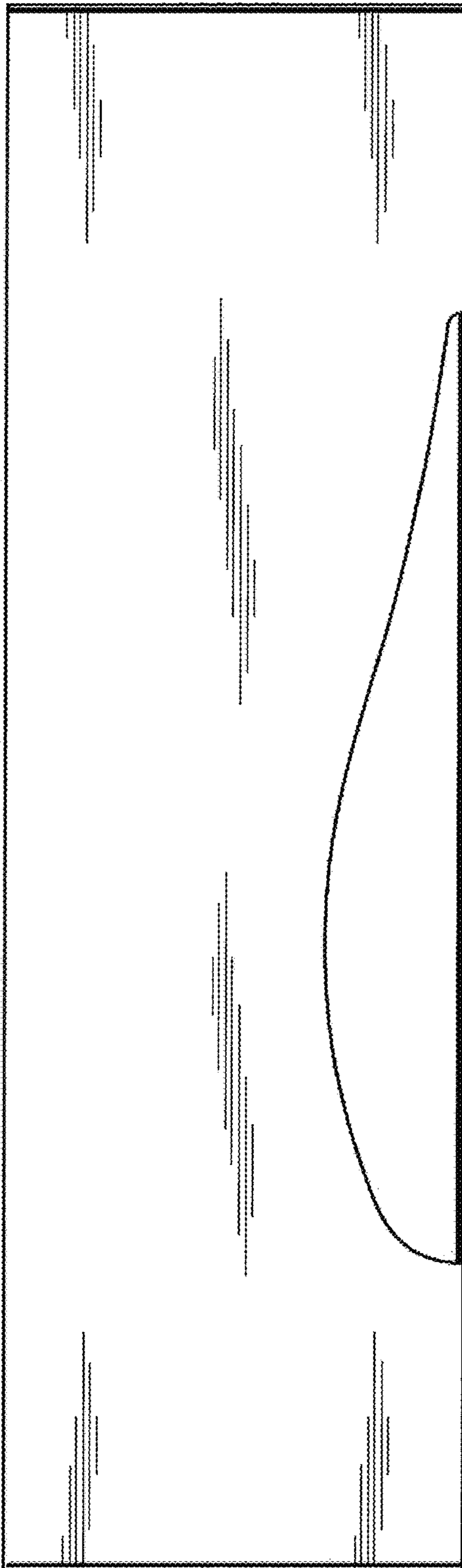

FIG. 4

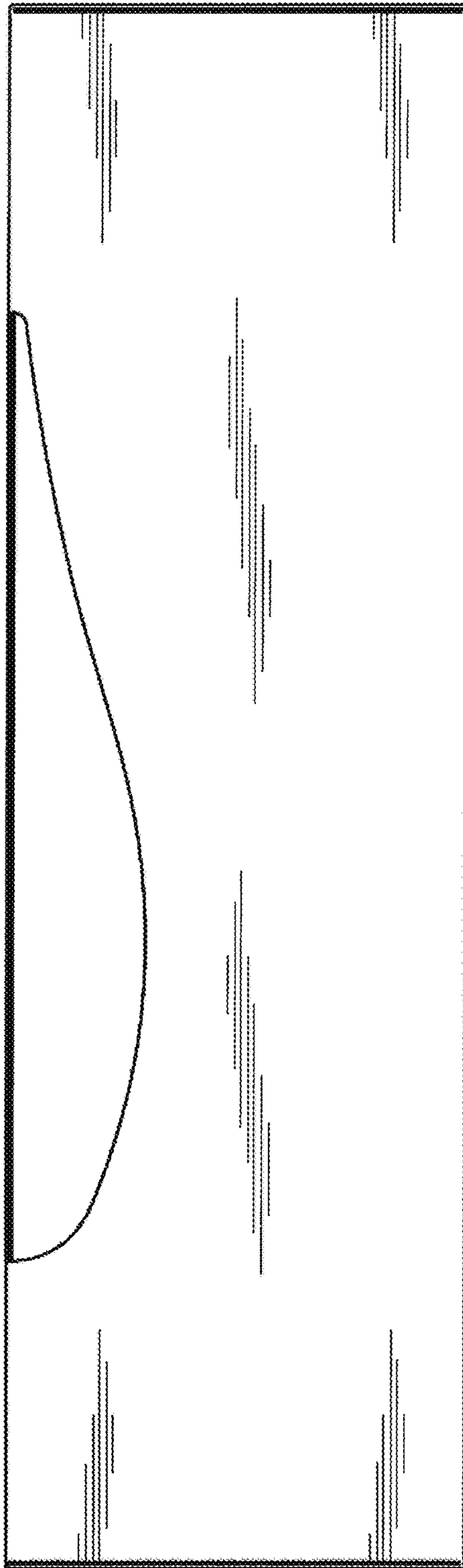

FIG. 5

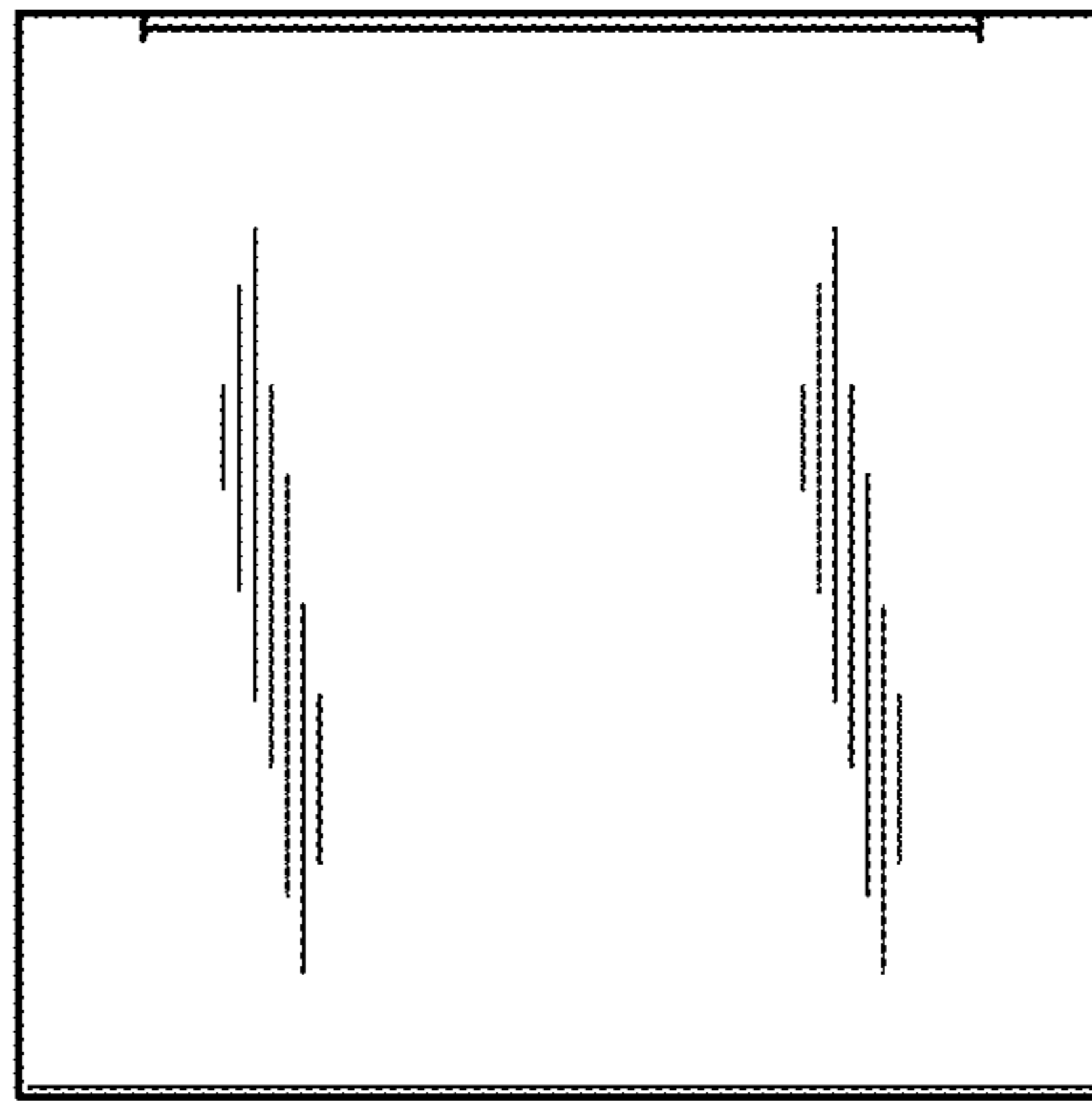

FIG. 6

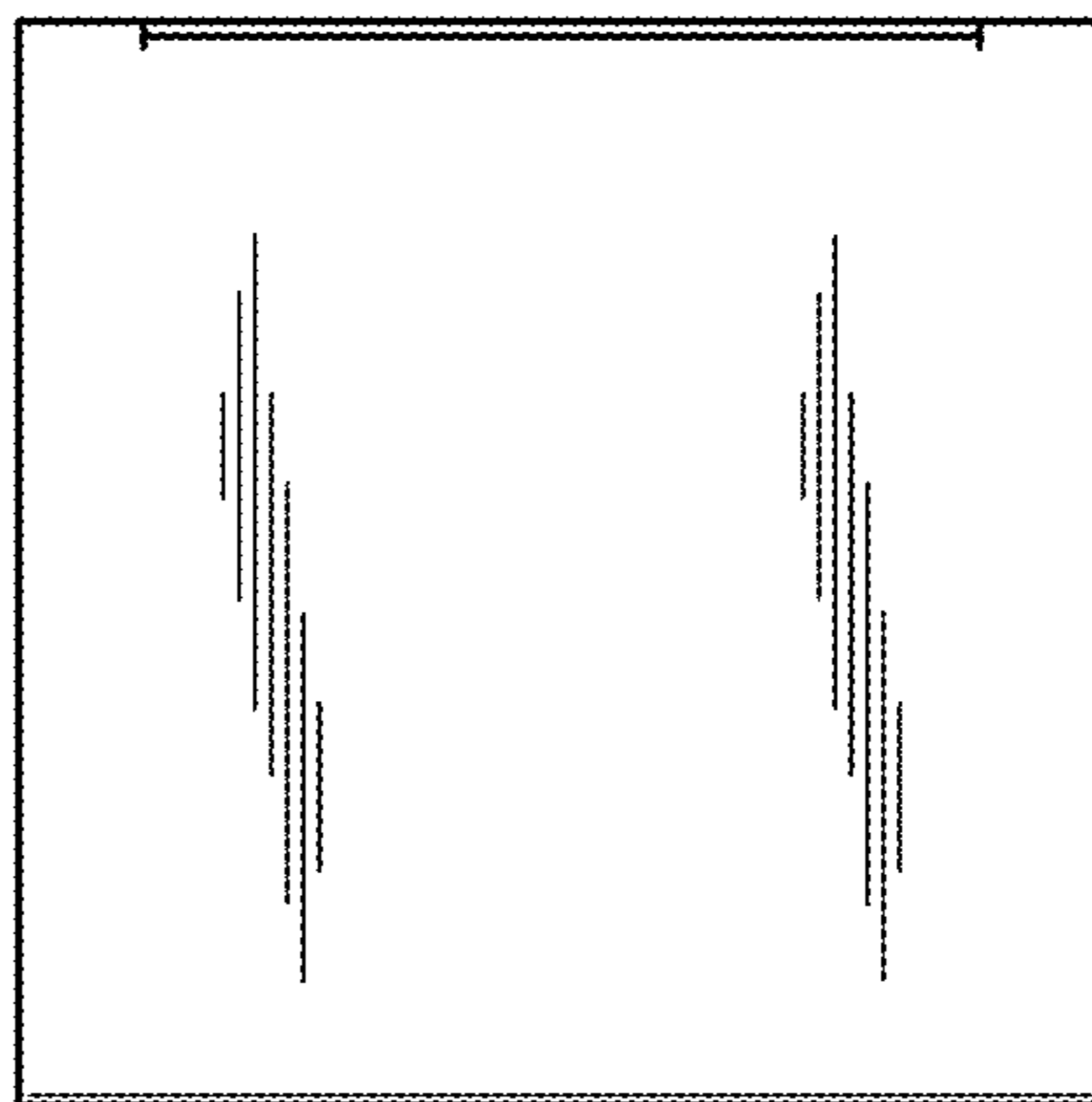

FIG. 7

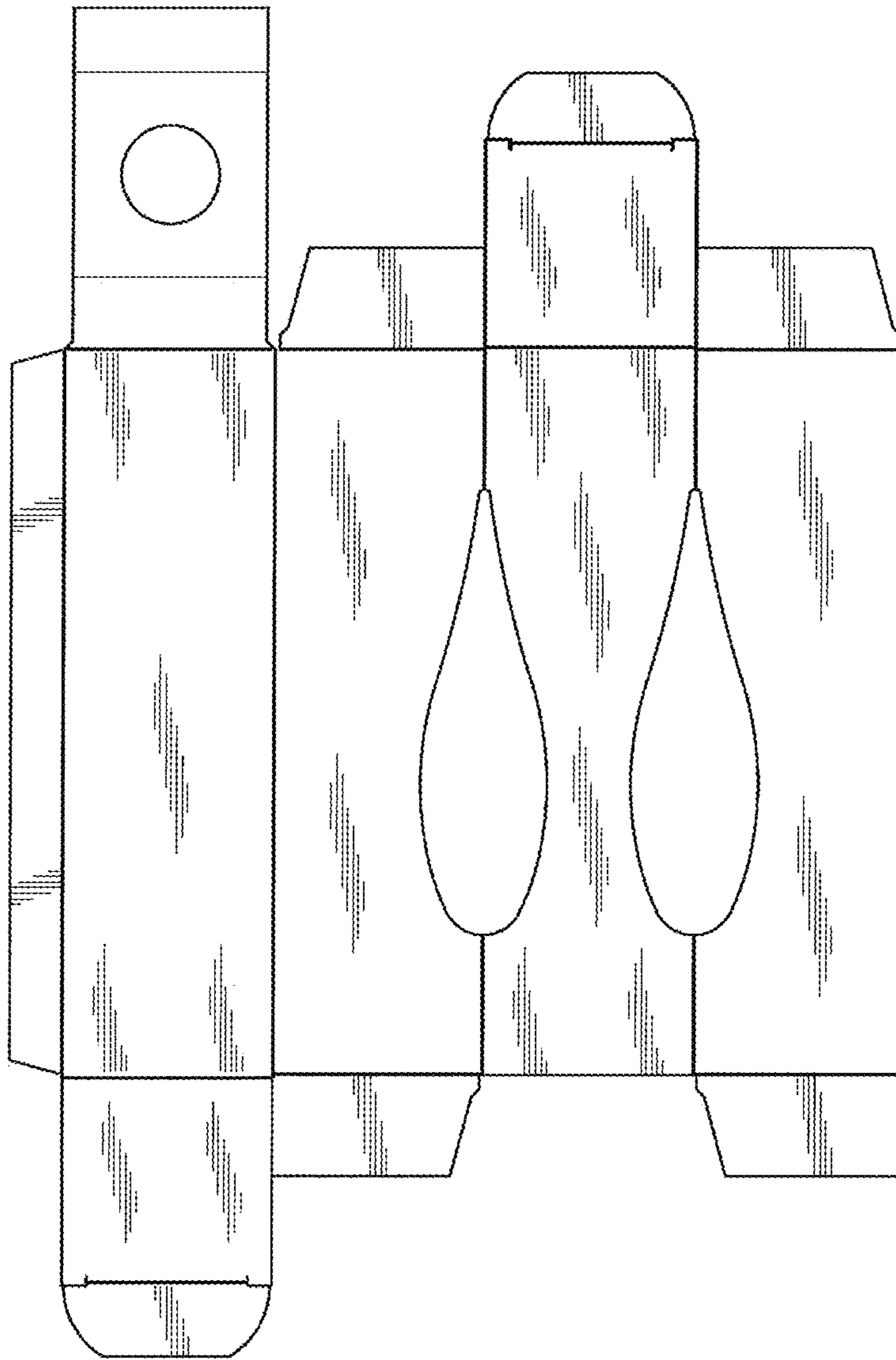

FIG. 8