



US00D787926S

(12) **United States Design Patent**
Cramer

(10) **Patent No.:** **US D787,926 S**

(45) **Date of Patent:** **** May 30, 2017**

(54) **CLIP**

(71) Applicant: **Jonathan Victor Cramer**, Bilgola Plateau (AU)

(72) Inventor: **Jonathan Victor Cramer**, Bilgola Plateau (AU)

(**) Term: **15 Years**

(21) Appl. No.: **29/565,045**

(22) Filed: **May 17, 2016**

(30) **Foreign Application Priority Data**

Nov. 17, 2015 (AU) 201516192

(51) **LOC (10) Cl.** **08-08**

(52) **U.S. Cl.**
USPC **D8/394**

(58) **Field of Classification Search**
USPC D8/71, 72, 373, 354, 383, 394-396, 499;
D19/56, 65, 68, 196, 199, 203; 24/22,
24/20 S, 115 R, 546, 563, 910, 343, 67.9,
24/67.3, 6, 13, 340, 351, 354, 355, 570,
24/327, 334, 3.12; 248/74.2, 215, 227.1,
248/49, 300, 301, 316.7, 51, 489, 231.81;
132/200, 277-279, 126, 132, 128, 138,
132/189, 148; D28/9.1, 25-29, 31-32,
D28/39, 40, 42, 43; D32/60-64;
D11/200, 202, 203, 206, 210, 212, 215
CPC .. F16B 2/005; F16B 12/32; F16B 7/04; F16B
9/023

See application file for complete search history.

(56) **References Cited**

U.S. PATENT DOCUMENTS

D410,302 S * 5/1999 Yasuda D28/40
D415,855 S * 10/1999 Fergusson D28/29
D473,014 S * 4/2003 Shyu D28/40
D566,895 S * 4/2008 Vergona D28/40

D590,102 S * 4/2009 Hsu D28/39
D605,361 S * 12/2009 Hsu D28/42
D642,738 S * 8/2011 Hsu D28/40
8,307,835 B2 * 11/2012 King A45D 8/24
132/200
8,381,359 B1 * 2/2013 McArdle A45F 5/02
2/209.13
D682,080 S * 5/2013 Borovicka D8/395
D707,546 S * 6/2014 Katz D8/394

(Continued)

OTHER PUBLICATIONS

Etsy "78mm Glossy Acrylic Hair Claw in Black or Brown. <10PCS-23 X 78mm", www.Etsy.com. Jan. 6, 2015. shown in p. 1.*

(Continued)

Primary Examiner — Cynthia Ramirez

Assistant Examiner — Michael Maharajh

(74) *Attorney, Agent, or Firm* — Banner & Witcoff, Ltd.

(57) **CLAIM**

The ornamental design for a clip, as shown and described.

DESCRIPTION

FIG. 1 is a top, front, left perspective view of a clip, showing my new design;
FIG. 2 is a front view thereof;
FIG. 3 is a right side view thereof;
FIG. 4 is a left side view thereof;
FIG. 5 is a top view thereof;
FIG. 6 is a top, rear, right perspective view thereof, in an open position;
FIG. 7 is a front elevational view thereof, in an open position;
FIG. 8 is a right side elevational view thereof, in an open position;
FIG. 9 is a left side elevational view thereof, in an open position; and,
FIG. 10 is a top plan view thereof, in an open position.

1 Claim, 8 Drawing Sheets

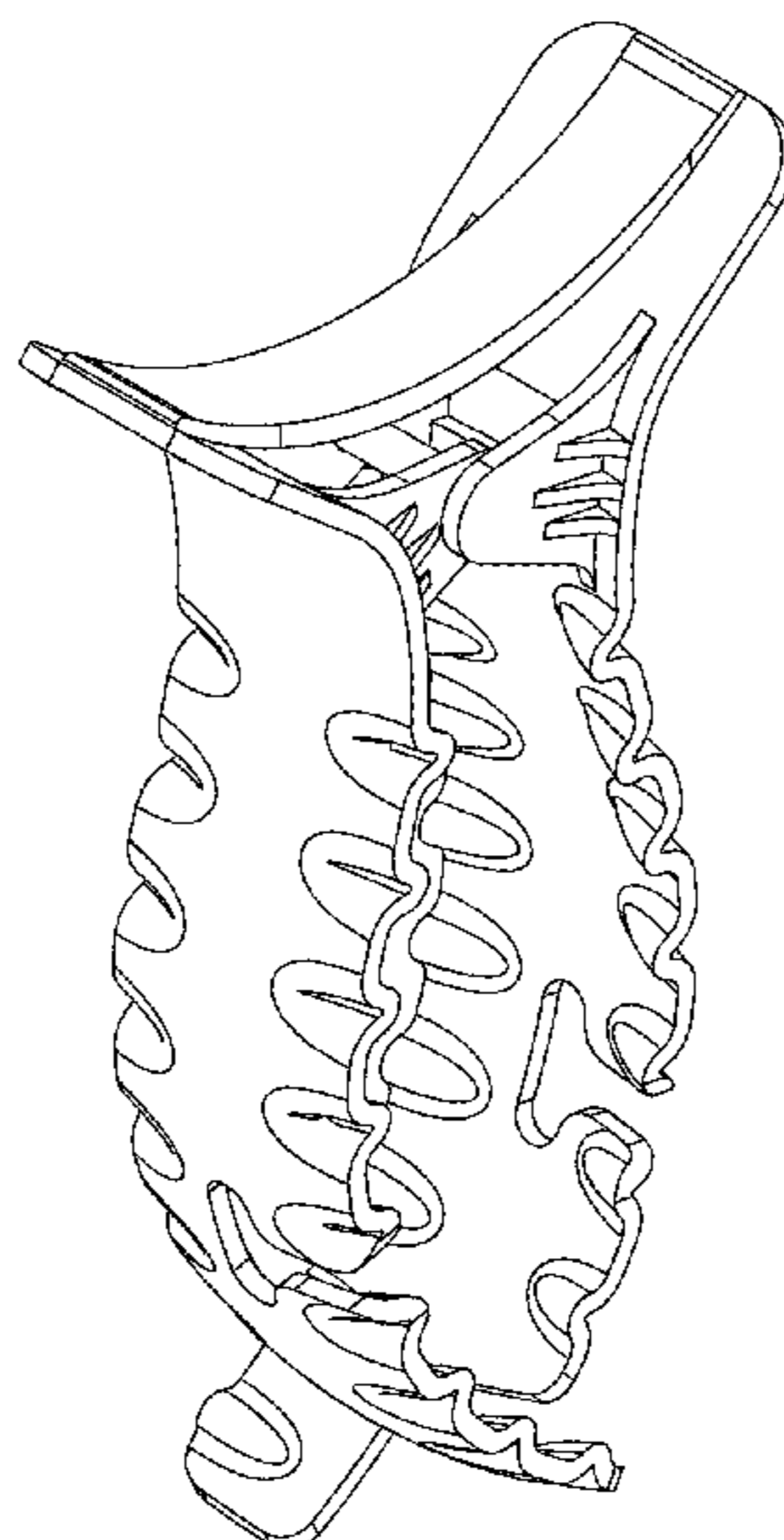

(56)

References Cited

U.S. PATENT DOCUMENTS

D752,965 S * 4/2016 Blaney D8/394
9,392,864 B2 * 7/2016 Reed A45F 5/021
2014/0144460 A1 * 5/2014 Hall A45D 8/20
132/277
2015/0020842 A1 * 1/2015 Park A45D 8/20
132/279

OTHER PUBLICATIONS

Speert "346-Hair-Claw 1 Size Fits AllTortoise Clincher", www.
speert.com. Jan. 23, 2017. shown in p. 1.*
Amazon "Prettyou Pure Color 3.7" Banana Hair Clip for Women
Girls, Pack of 3", www.Amazon.com. Mar. 19, 2016. shown in p.
1. Item # B013W0KIVU.*

* cited by examiner

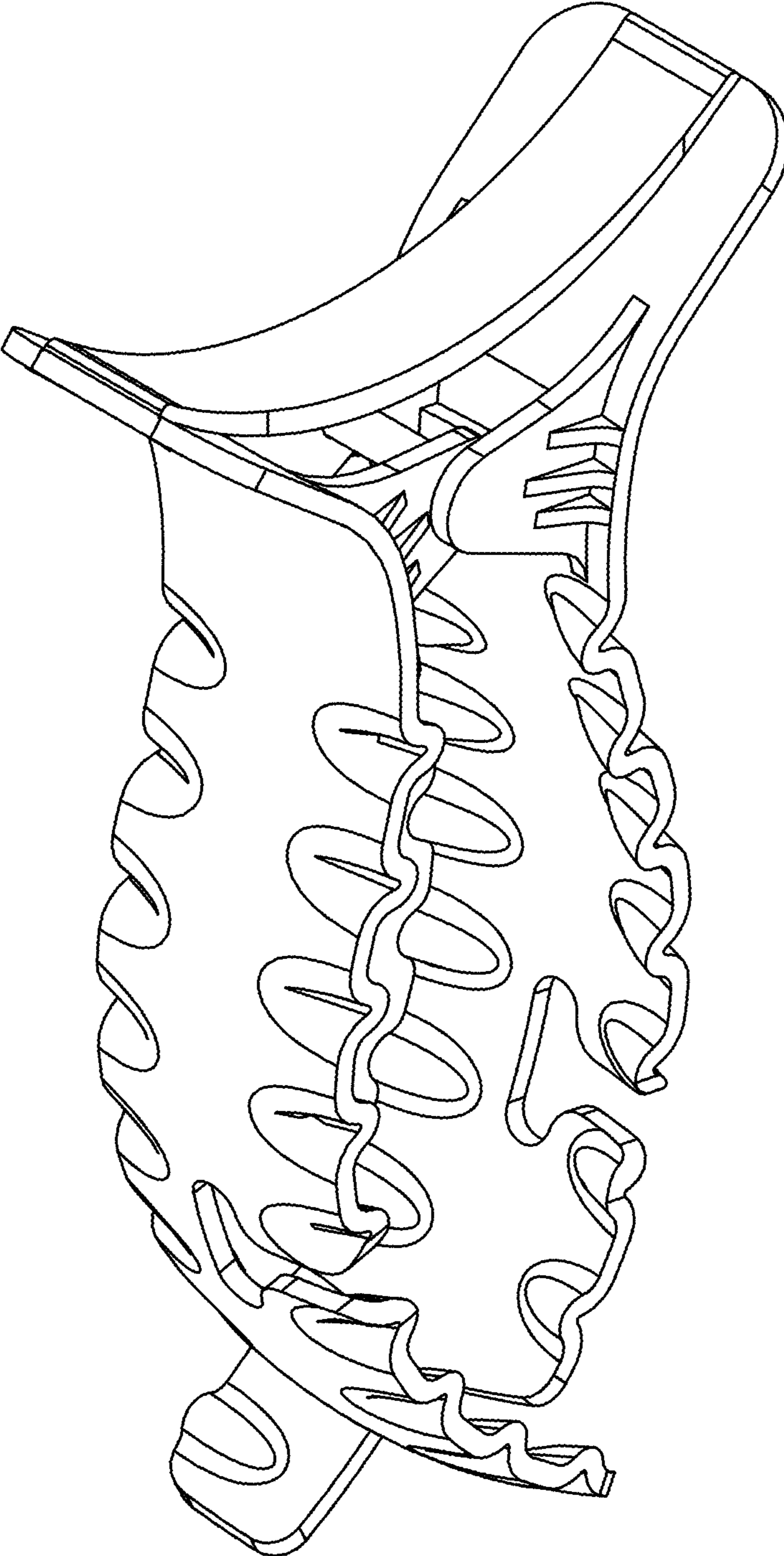

FIG. 1

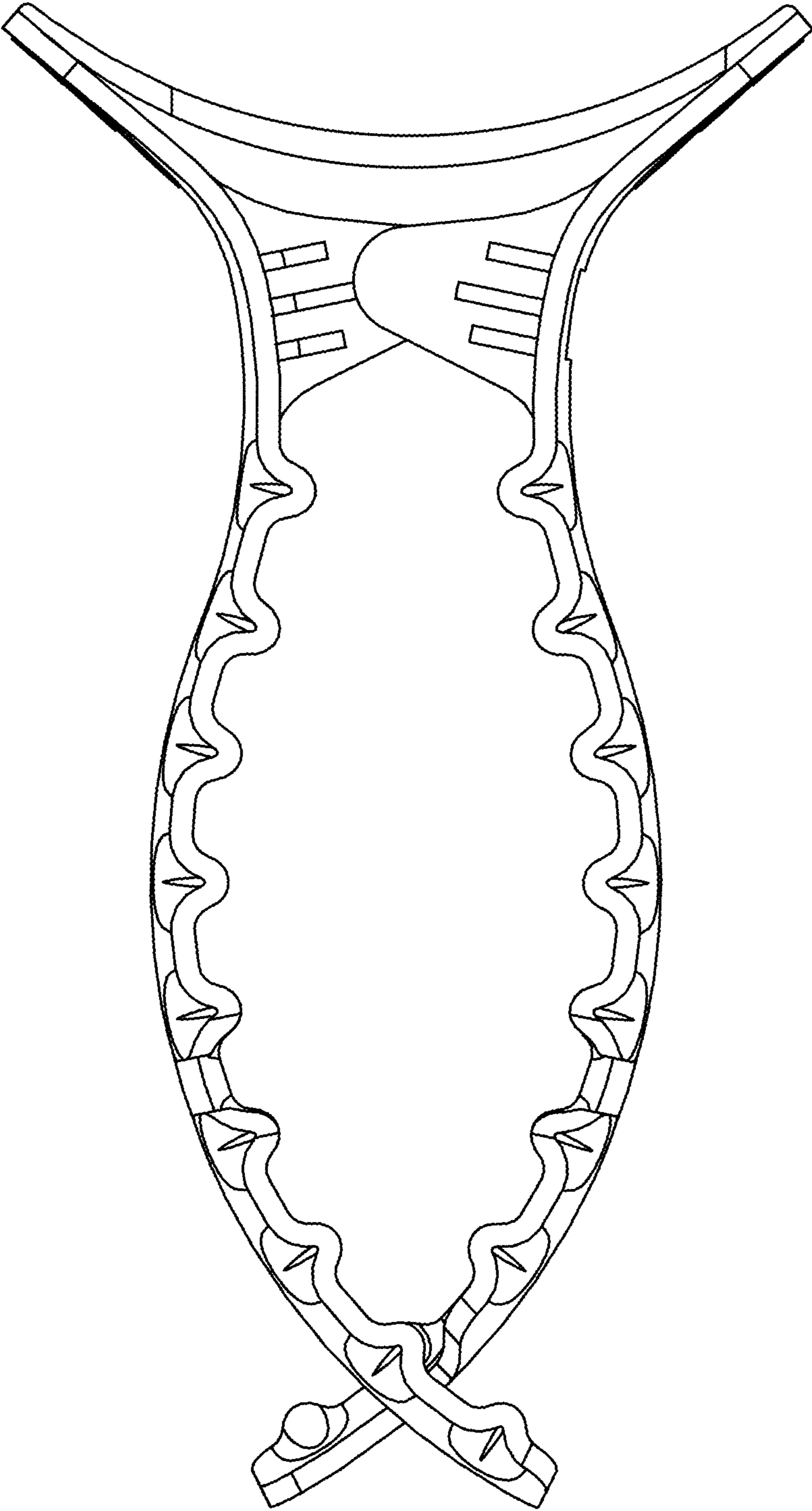

FIG. 2

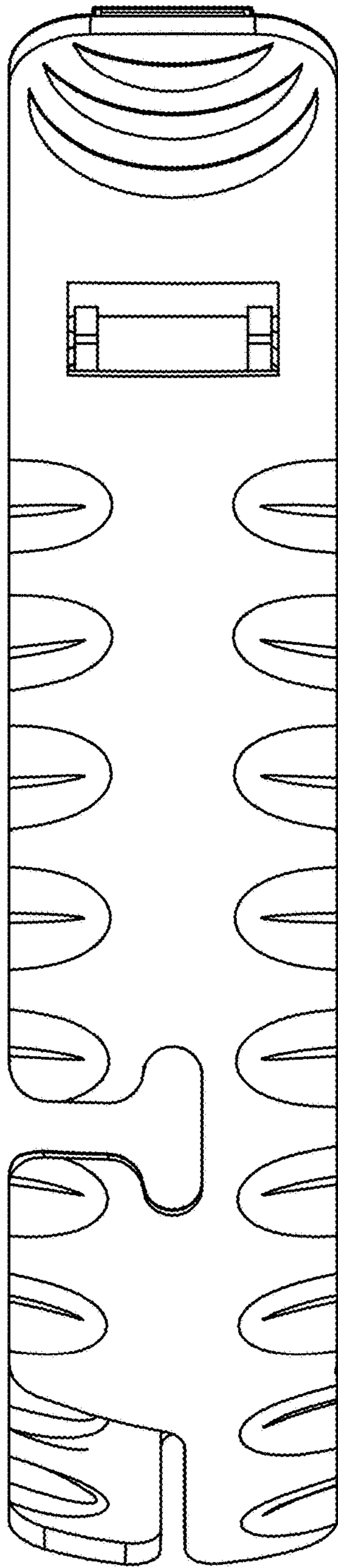

FIG. 3

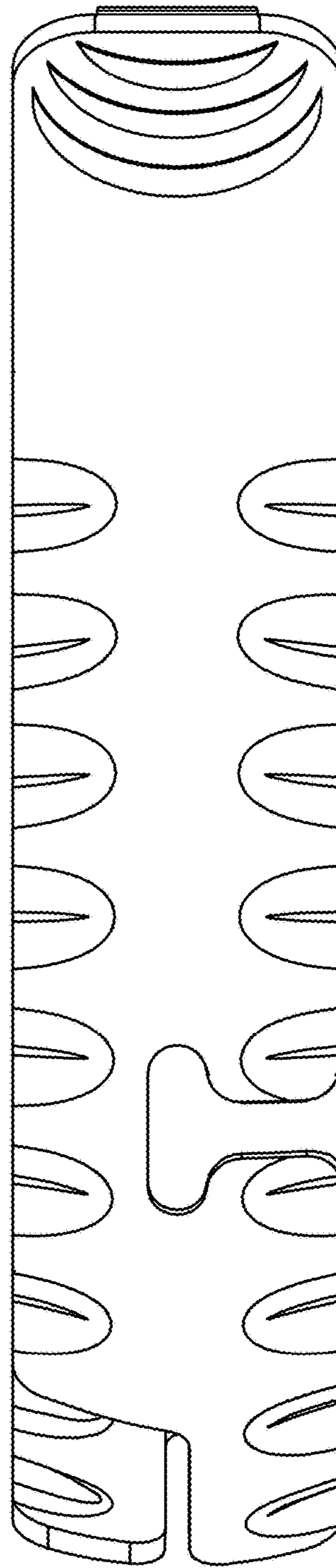

FIG. 4

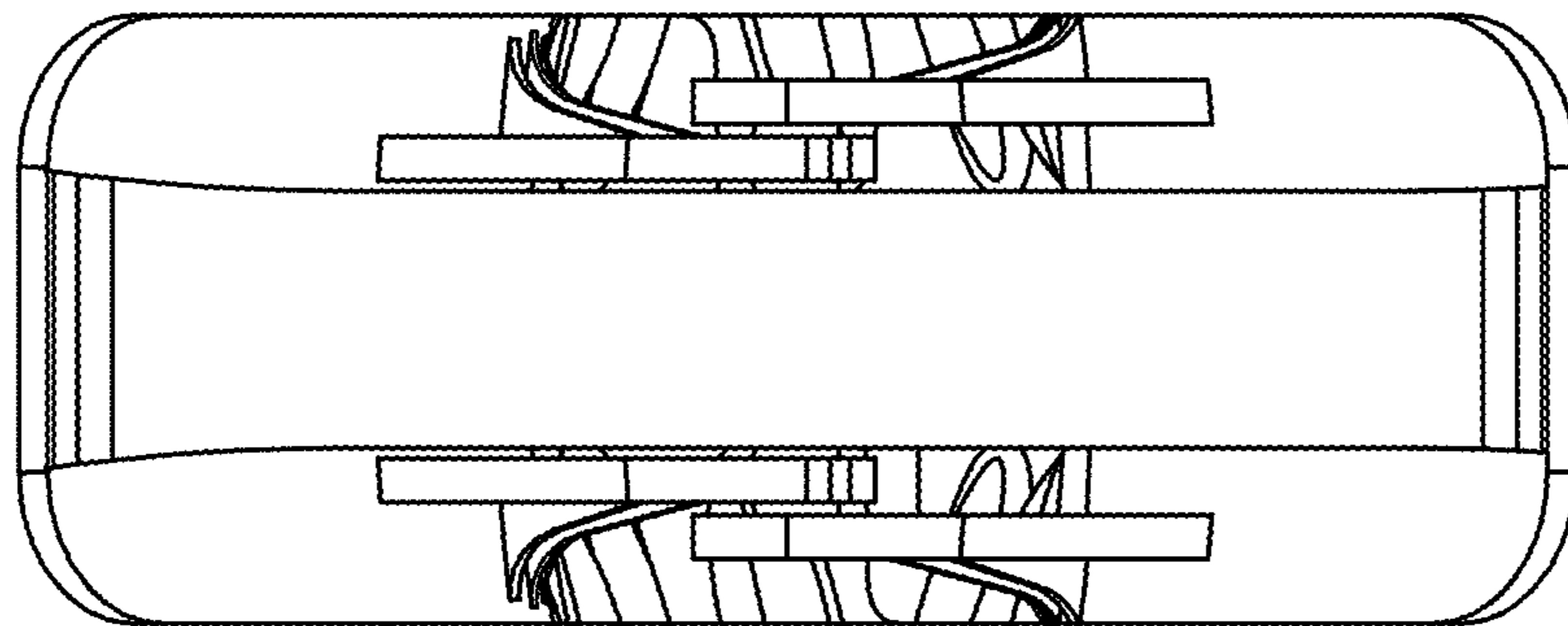

FIG. 5

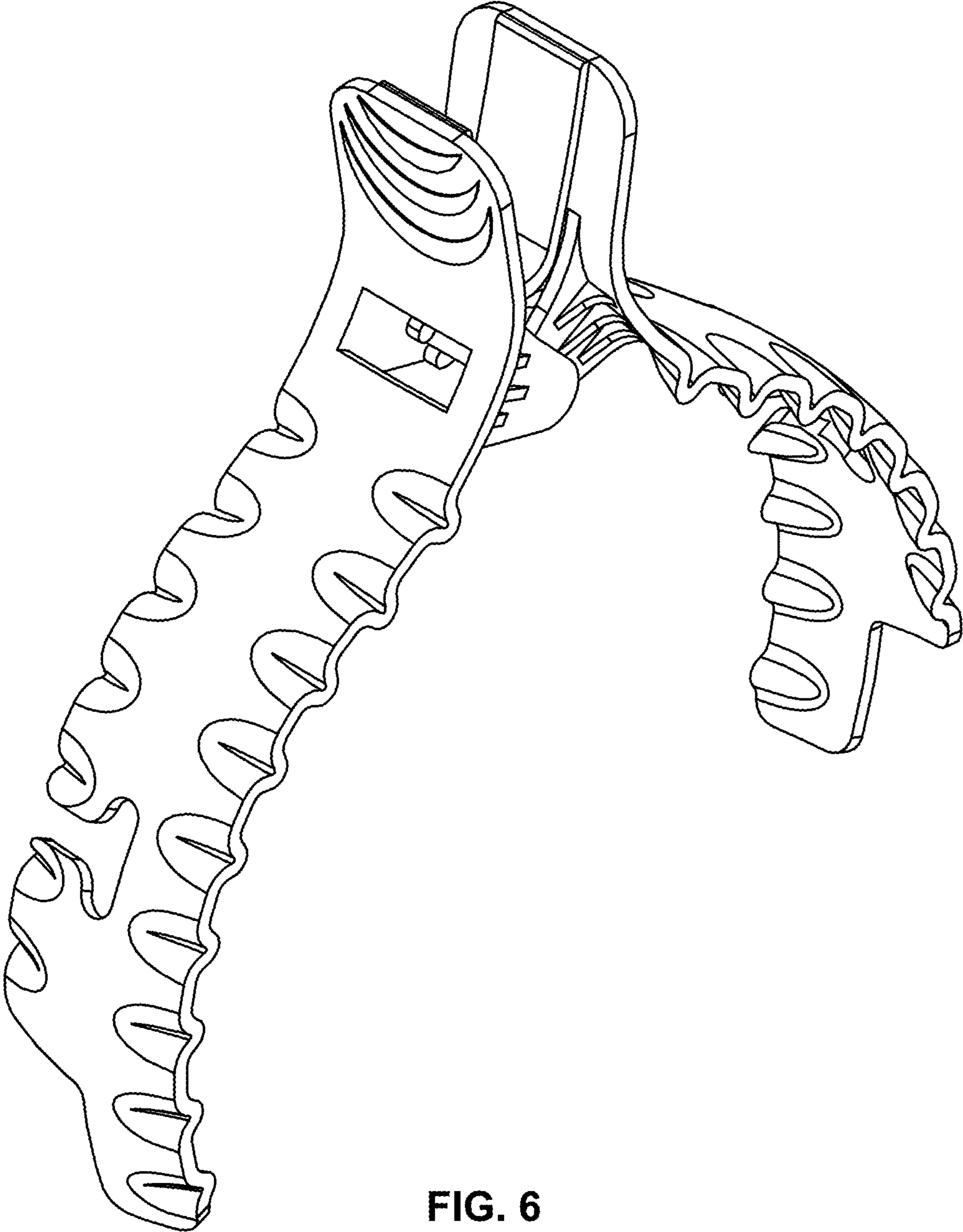

FIG. 6

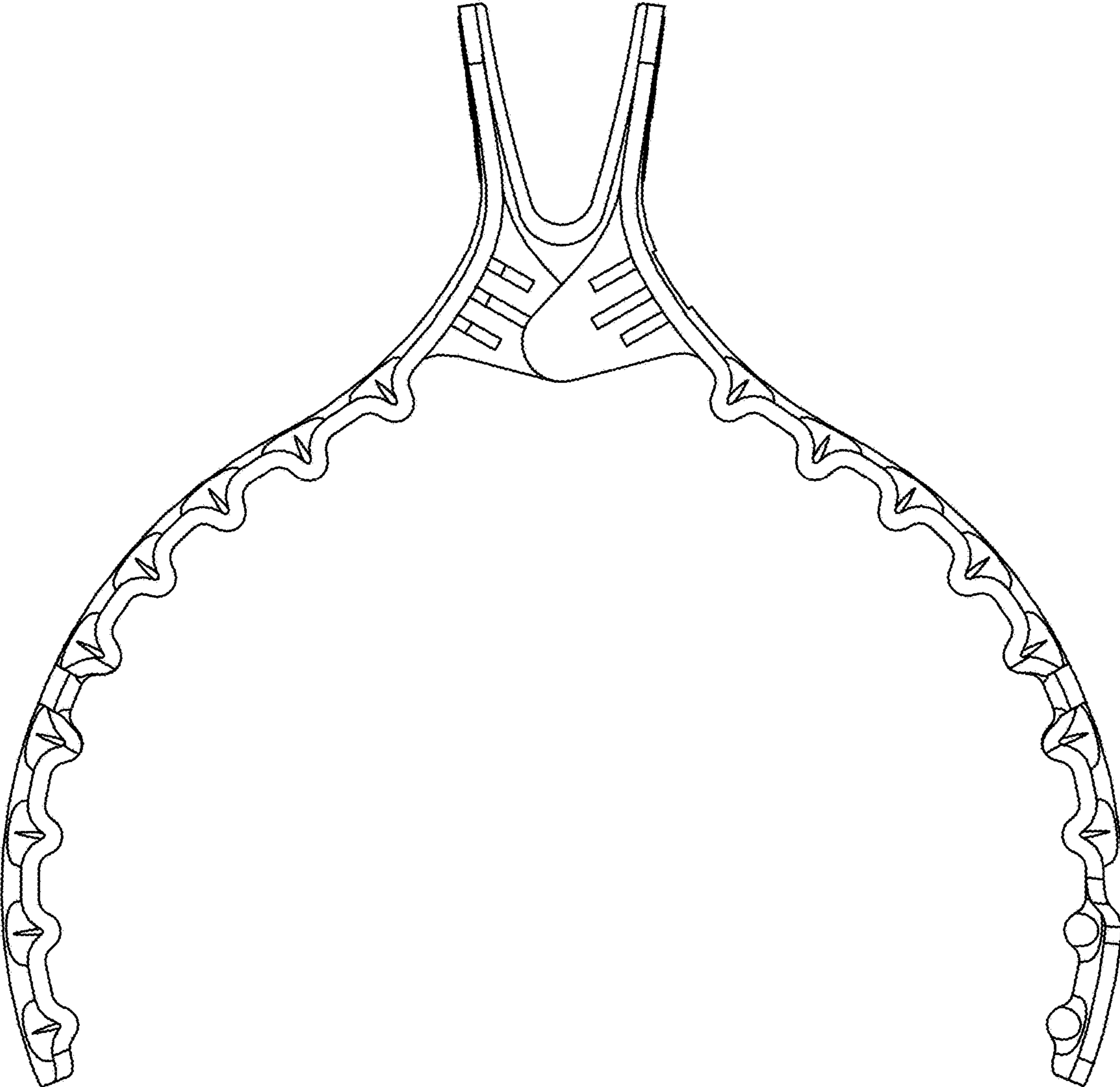

FIG. 7

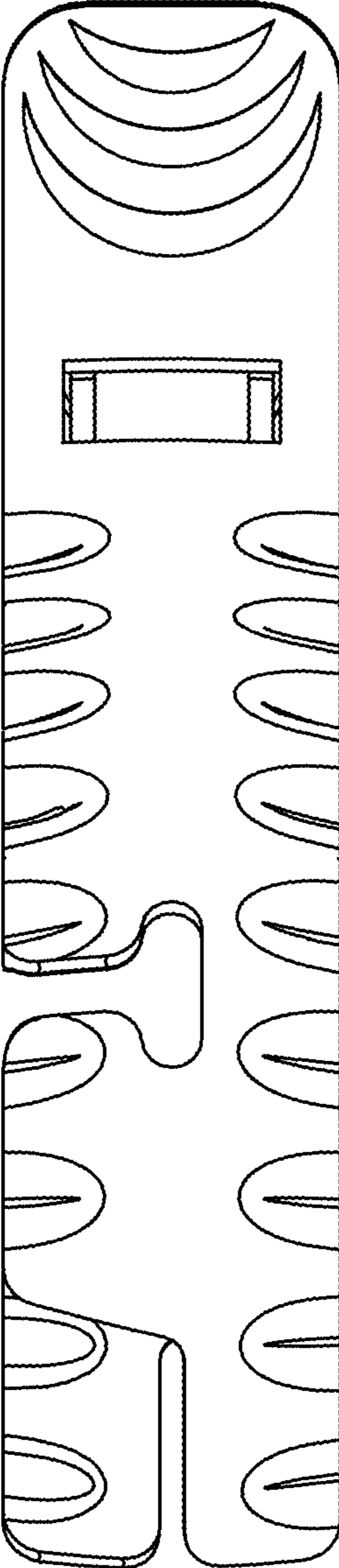

FIG. 8

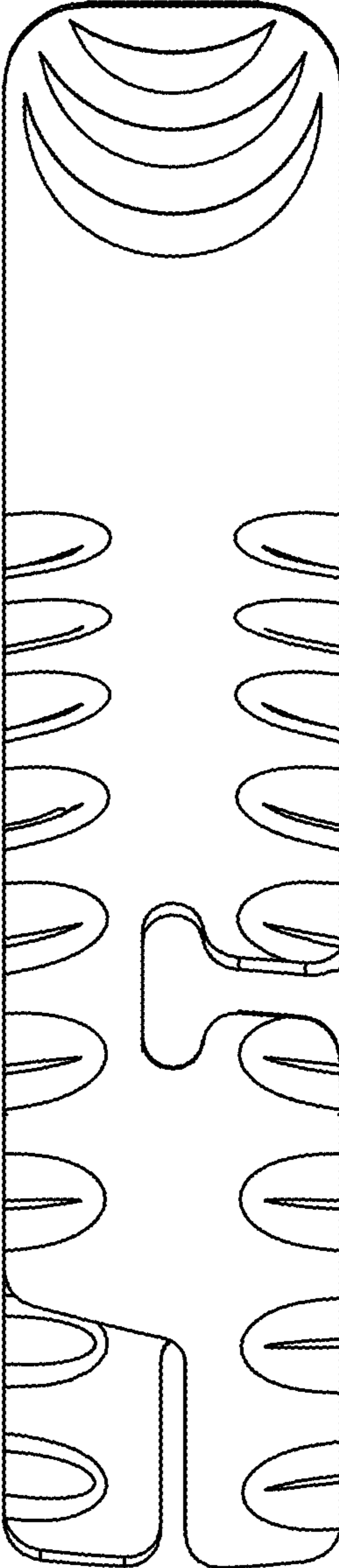

FIG. 9

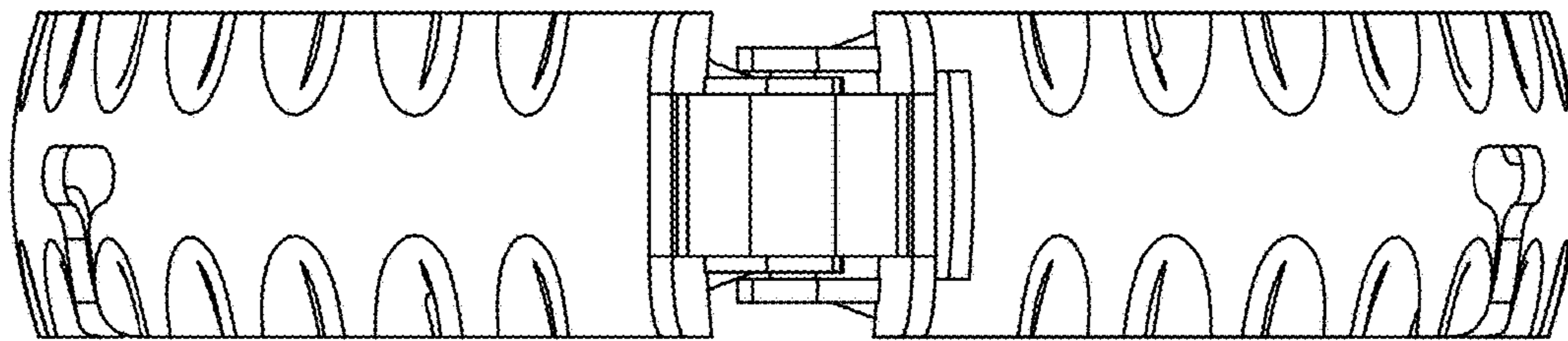

FIG. 10