



US00D787884S

(12) **United States Design Patent**
Bartlett et al.

(10) **Patent No.:** **US D787,884 S**

(45) **Date of Patent:** **** May 30, 2017**

(54) **WATER BOTTLE**

(71) Applicant: **Overton Enterprises, LLC**, Austin, TX (US)

(72) Inventors: **Peter C. Bartlett**, Austin, TX (US);
Redza M. Shah, Austin, TX (US);
Kimberley J. Overton, Austin, TX (US)

(73) Assignee: **OVERTON ENTERPRISES, LLC**, Austin, TX (US)

(**) Term: **15 Years**

(21) Appl. No.: **29/535,053**

(22) Filed: **Aug. 3, 2015**

(51) **LOC (10) Cl.** **07-01**

(52) **U.S. Cl.**

USPC **D7/510; D7/507; D7/533; D3/202**

(58) **Field of Classification Search**

USPC **D7/509, 510, 511, 523, 529, 532, 533, D7/535, 536, 300, 300.1, 608, 629, 387, D7/304-315, 534, 396.1, 524, 537, 572, D7/392.1, 391; D9/503, 504, 531, 530, D9/566, 544, 549, 550, 553, 554, 516, D9/537, 454, 434; 215/228, 229; 220/592.2, 592.16, 592.17; D23/202, D23/207; 99/281, 305, 307; 222/146.6; 141/247; D24/122; D3/202**

CPC **A47G 19/22; A47G 19/2227; A47G 19/02; A47G 19/025; A47G 19/2288; Y10S 220/903**

See application file for complete search history.

(56) **References Cited**

U.S. PATENT DOCUMENTS

3,716,871 A * 2/1973 Borse A61G 9/006
215/398
4,270,231 A * 6/1981 Zint A61G 9/006
4/144.1

5,178,308 A * 1/1993 Endre B62J 11/00
215/306
D443,980 S * 6/2001 Stewart D3/202
D497,245 S * 10/2004 Willows D3/202
D555,428 S * 11/2007 Tulett D7/510
D569,097 S * 5/2008 Leslie D3/202
D598,644 S * 8/2009 Solari D3/202
D671,359 S * 11/2012 Windmiller D7/392.1
D675,480 S * 2/2013 Thomas D7/507
D687,222 S * 8/2013 Willows D3/229
9,210,992 B2 * 12/2015 deBeers A45F 5/02
9,320,375 B2 * 4/2016 Sweeney G01F 13/006
D756,792 S * 5/2016 Genaw, Jr. D9/522
D769,063 S * 10/2016 Sweeney D7/392.1
D771,803 S * 11/2016 Tanguay D24/122
2003/0098324 A1 * 5/2003 Litton B62J 9/001
224/414
2005/0258201 A1 * 11/2005 Willows B65D 25/22
224/148.4

(Continued)

Primary Examiner — Marianne Pandozzi

Assistant Examiner — Jae Liang

(74) *Attorney, Agent, or Firm* — Conley Rose, P.C.

(57) **CLAIM**

The ornamental design for a water bottle, as shown.

DESCRIPTION

FIG. 1 is a perspective view of a water bottle showing our new design;

FIG. 2 is a front elevational view thereof;

FIG. 3 is a rear elevational view thereof;

FIG. 4 is a first side elevational view thereof;

FIG. 5 is a second side elevational view thereof;

FIG. 6 is a top elevational view thereof; and,

FIG. 7 is bottom elevational view thereof.

The broken lines in the drawing depict portions of the water bottle that form no part of the claimed design.

1 Claim, 7 Drawing Sheets

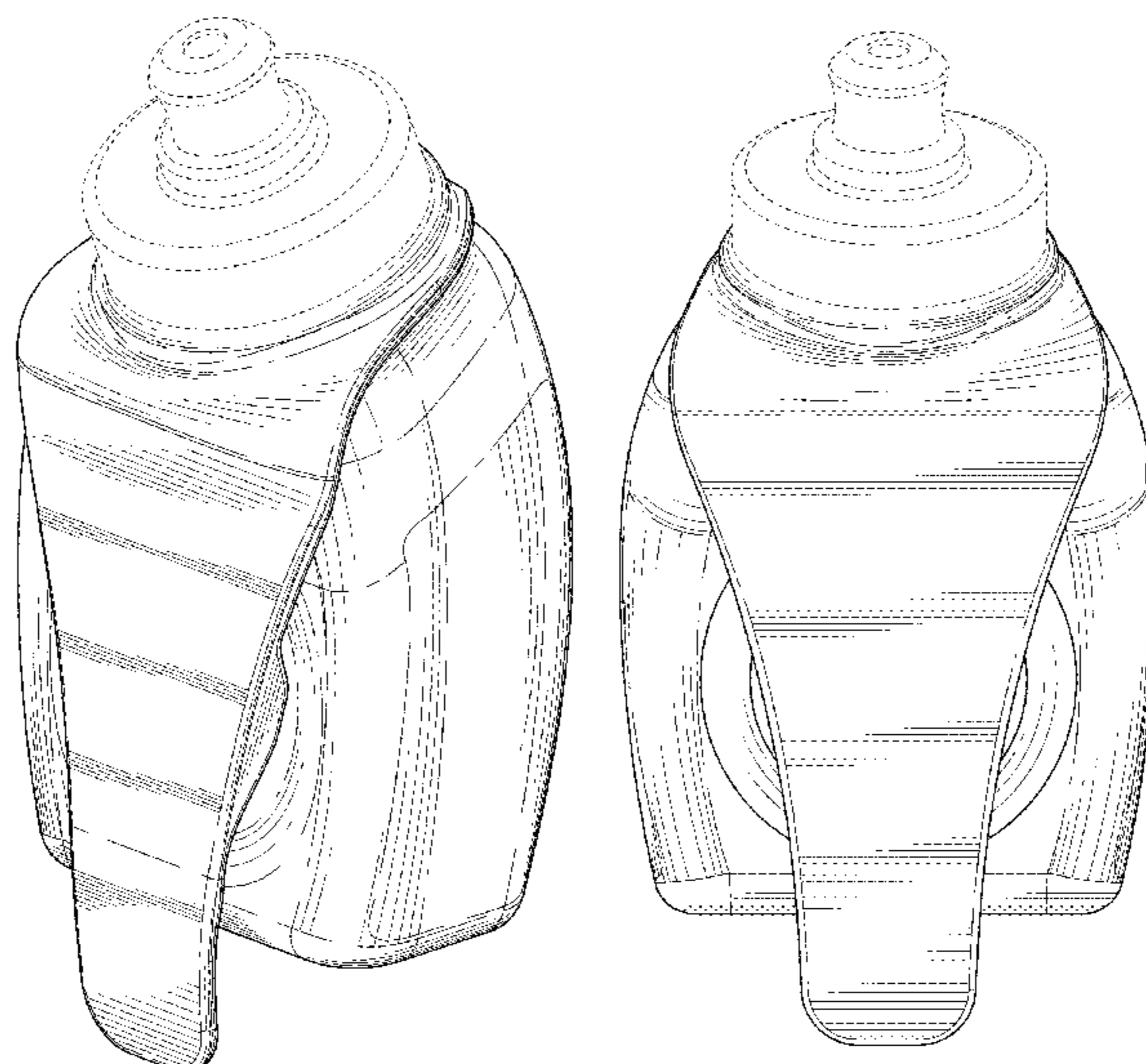

(56)

References Cited

U.S. PATENT DOCUMENTS

2014/0202982 A1* 7/2014 Willows A45F 5/021
215/384
2015/0196112 A1* 7/2015 Willows A45F 5/021
224/148.5

* cited by examiner

FIG. 1

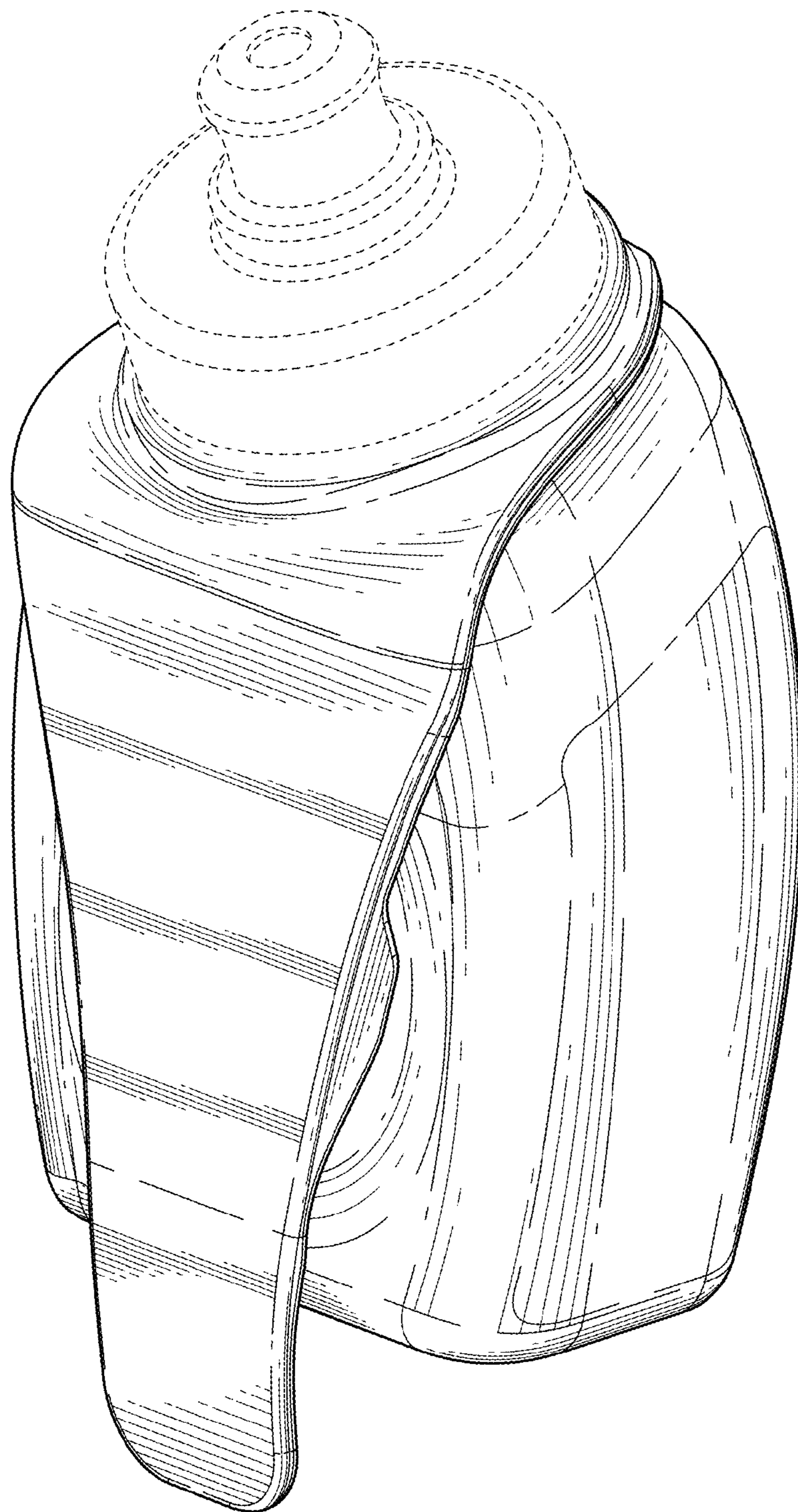

FIG. 2

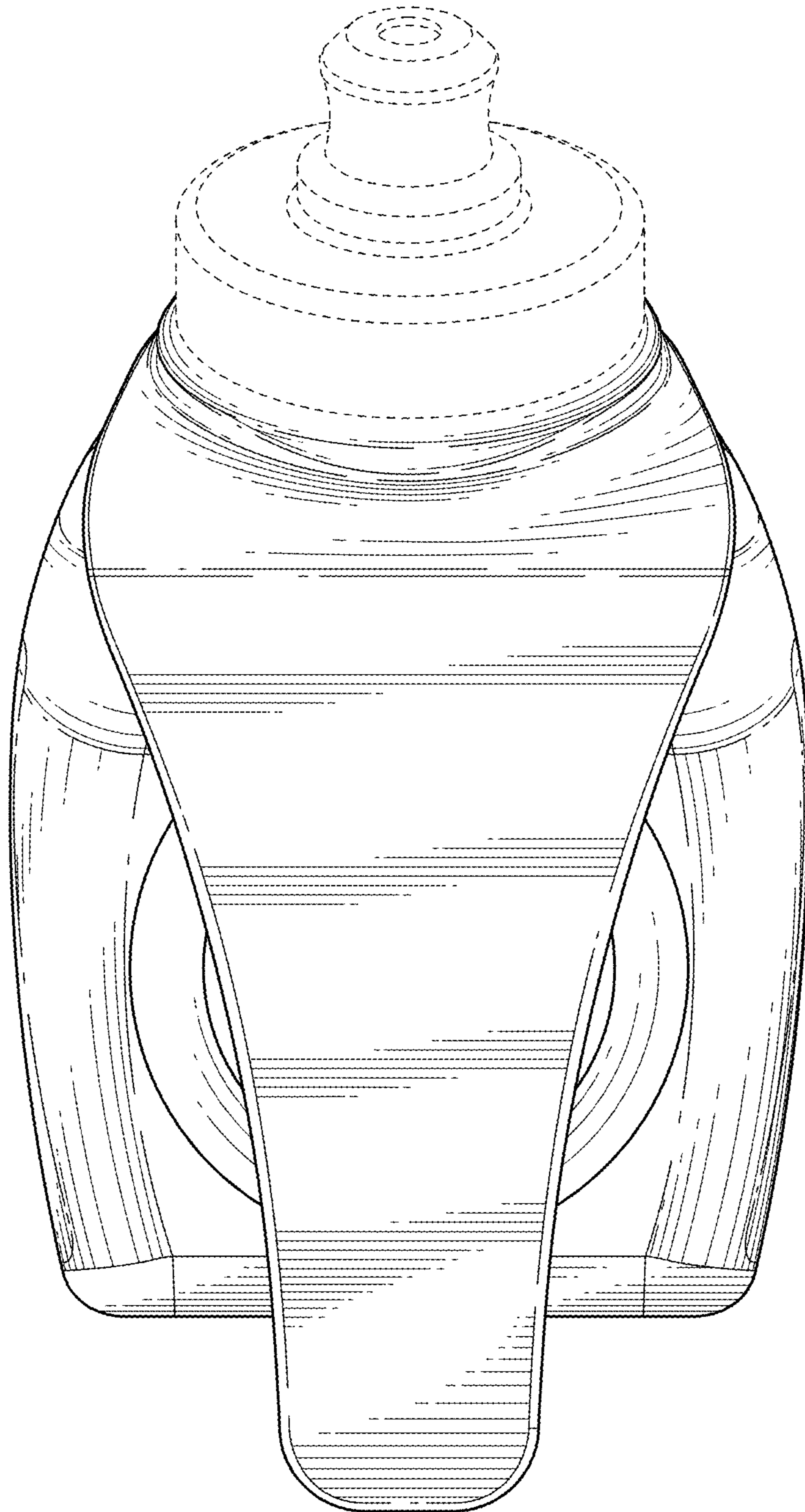

FIG. 3

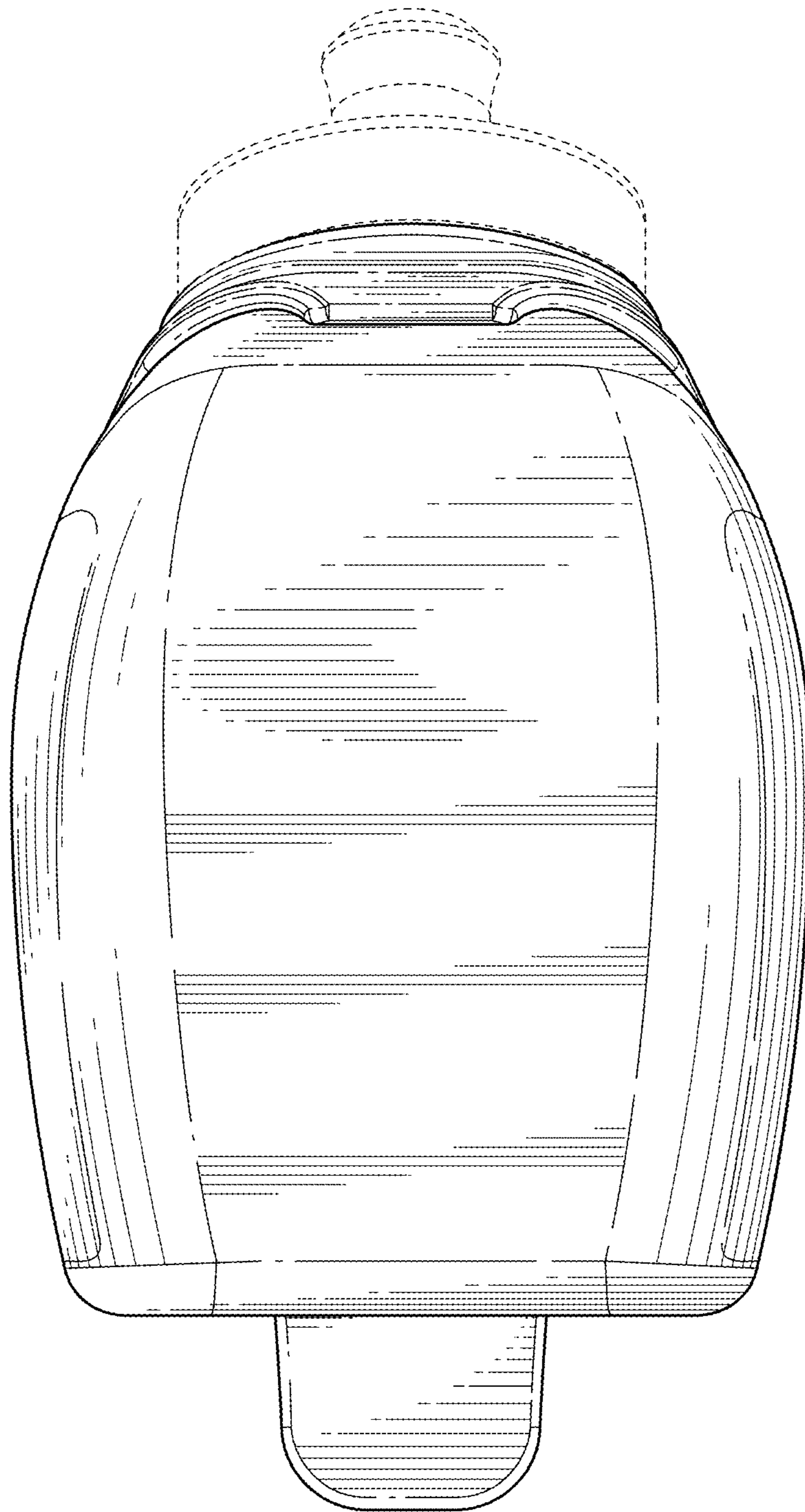

FIG. 4

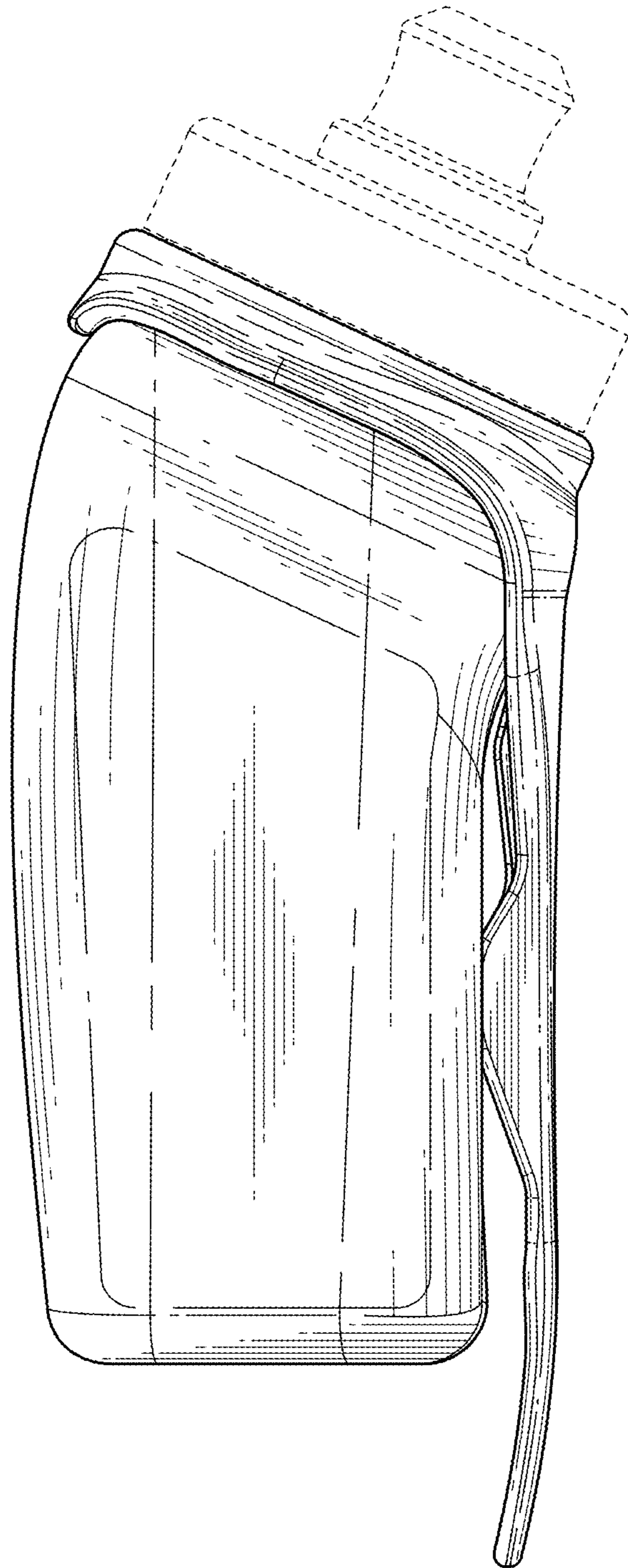

FIG. 5

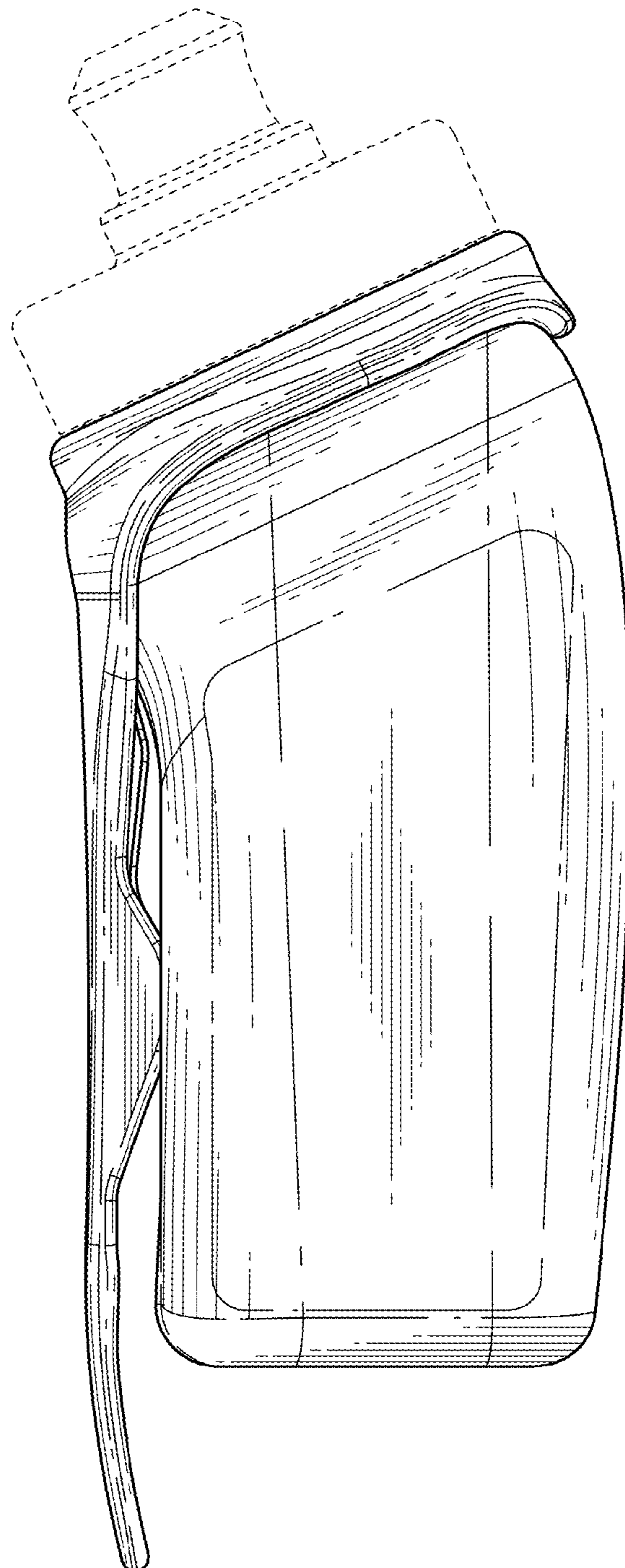
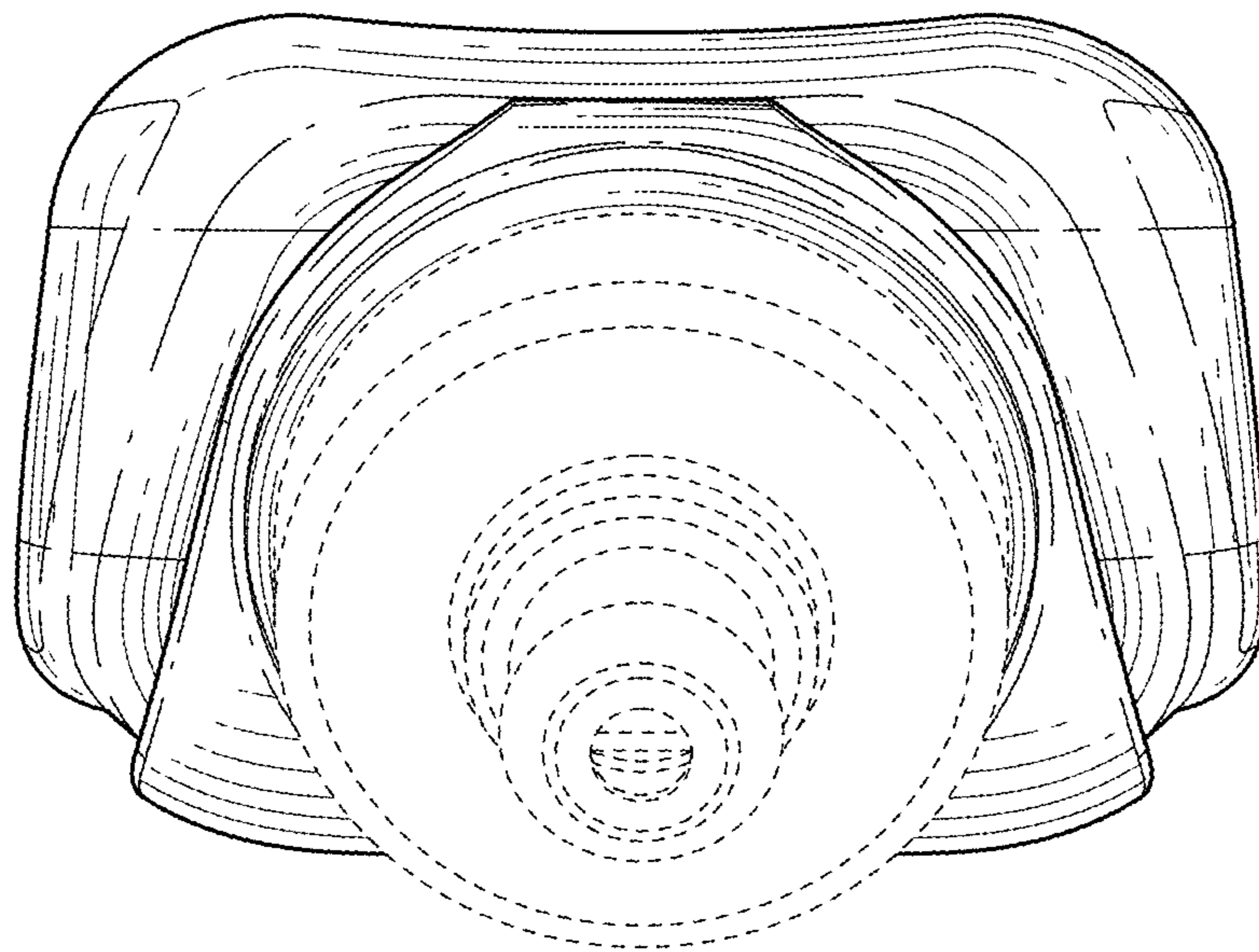

FIG. 6



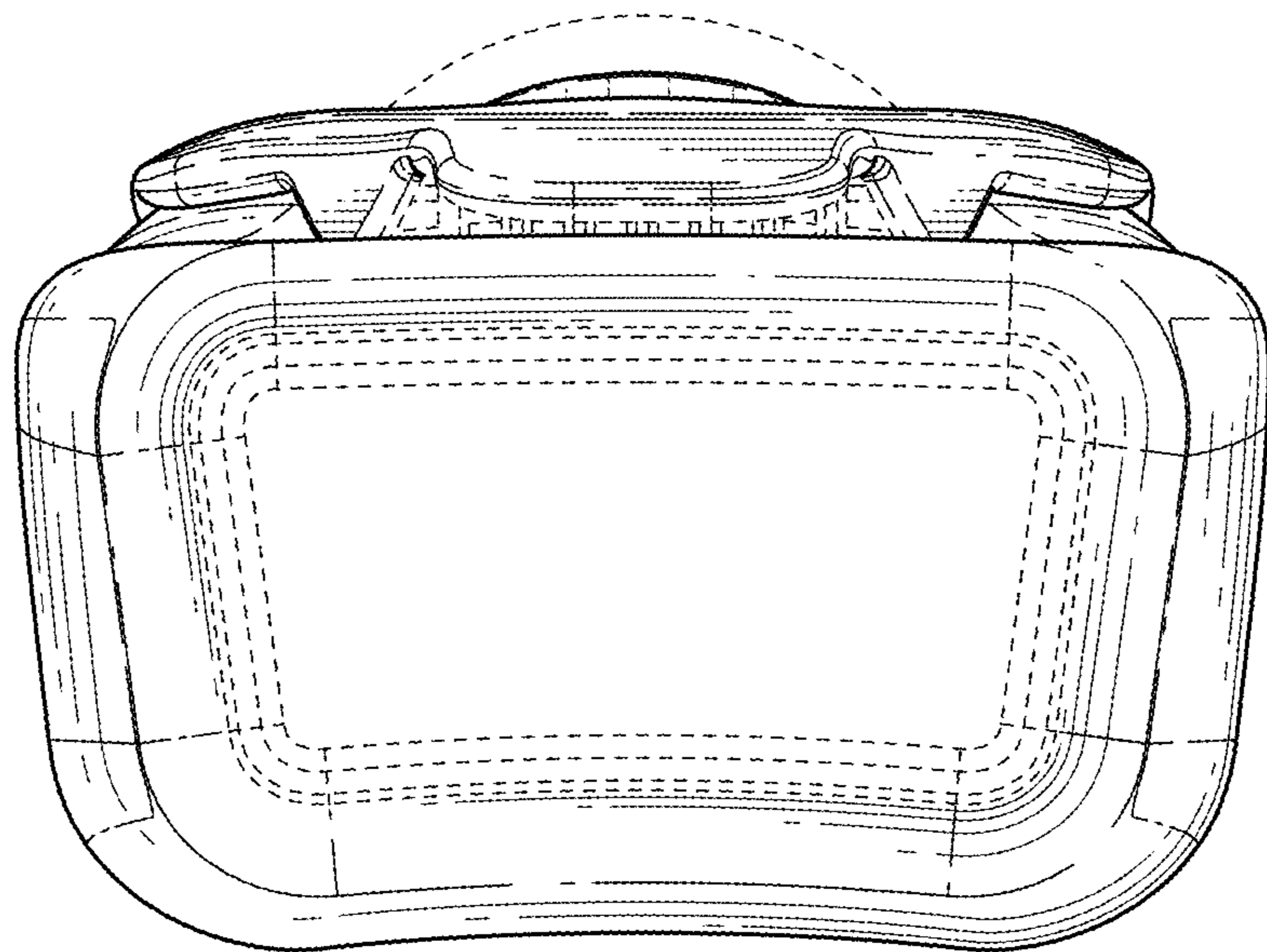

FIG. 7