



US00D787810S

(12) **United States Design Patent** (10) **Patent No.:** **US D787,810 S**
Wang et al. (45) **Date of Patent:** **** May 30, 2017**

- (54) **COVER FOR AN INHALER** 7,082,943 B1 * 8/2006 Clark A45F 5/00
128/200.23
- (71) Applicant: **CoheroHealth, LLC**, New York, NY (US) D549,958 S * 9/2007 Boyd D3/218
D556,444 S * 12/2007 Ipsen D3/203.1
D564,752 S * 3/2008 Badillo D3/218
D585,640 S * 2/2009 Case D3/218
- (72) Inventors: **Chun-Sheng Wang**, New Taipei (TW);
Jonathan David Piteo Tarcy,
Ellington, CT (US); **Russell Jon
Greenberg**, New York, NY (US);
Minchul Hong, New York, NY (US) D606,299 S * 12/2009 Boomhour D3/201
D623,737 S * 9/2010 Barker D24/128
D631,648 S * 2/2011 Pullin D3/203.1
D657,136 S * 4/2012 Kinskey D3/218
D657,551 S * 4/2012 Lynn D3/203.1
D666,410 S * 9/2012 Phillips D3/218
D728,234 S * 5/2015 Muller D3/201
D730,048 S * 5/2015 Muller D3/201
D773,176 S * 12/2016 Boyd D3/218
- (73) Assignee: **CoheroHealth, LLC**, New York, NY (US)

(**) Term: **15 Years**

(21) Appl. No.: **29/543,258**

(22) Filed: **Oct. 22, 2015**

(51) **LOC (10) Cl.** **03-01**

(52) **U.S. Cl.**
USPC **D3/203.1**

(58) **Field of Classification Search**
USPC D3/201, 203.1, 203.2, 203.3, 203.4,
D3/203.6, 203.7, 203.8, 218, 225, 226;
D24/110, 128
CPC A45F 5/02; A45F 5/021; A45F 2005/025;
A45F 2005/1006; A45F 2005/108; A45F
2200/05; A45F 2200/0566; A45C 13/001;
A45C 13/002; A61M 15/009; A61M
11/08
See application file for complete search history.

(56) **References Cited**

U.S. PATENT DOCUMENTS

- D389,570 S * 1/1998 Savolainen D24/110
- D395,147 S * 6/1998 Vidgren D24/110
- 6,196,431 B1 * 3/2001 Underhill A45F 5/02
224/237
- D453,264 S * 2/2002 Acevedo, Jr. D3/203.1
- 6,557,737 B1 * 5/2003 Hanson A45F 5/00
128/200.14

* cited by examiner

Primary Examiner — John Windmuller
Assistant Examiner — Steven Czyz
(74) *Attorney, Agent, or Firm* — Katten Muchin
Rosenman LLP

(57) **CLAIM**

The ornamental design for a cover for an inhaler, as shown and described.

DESCRIPTION

FIG. 1 is a perspective view of a cover for an inhaler, shown without environment and in the closed position;
FIG. 2 is a front view thereof;
FIG. 3 is a rear view thereof;
FIG. 4 is a right side view thereof;
FIG. 5 is a left side view thereof;
FIG. 6 is a top plan view thereof;
FIG. 7 is a bottom plan view thereof;
FIG. 8 is a perspective view of the cover for an inhaler, shown with an inhaler and in the closed position; and,
FIG. 9 is another perspective view of the cover for an inhaler, shown in the open position.
The broken lines depict portions of the article and environment that form no part of the claimed design.

1 Claim, 9 Drawing Sheets

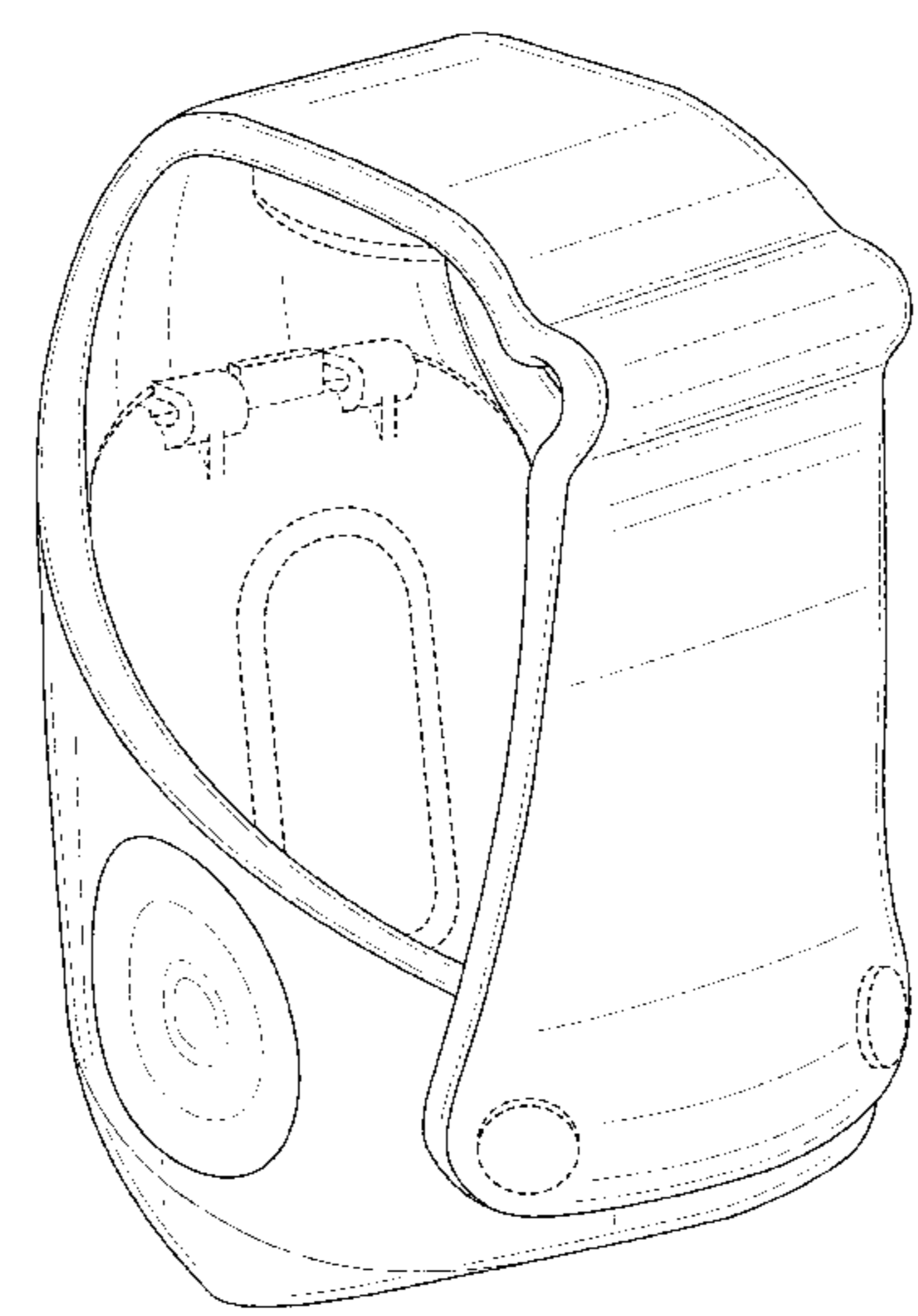

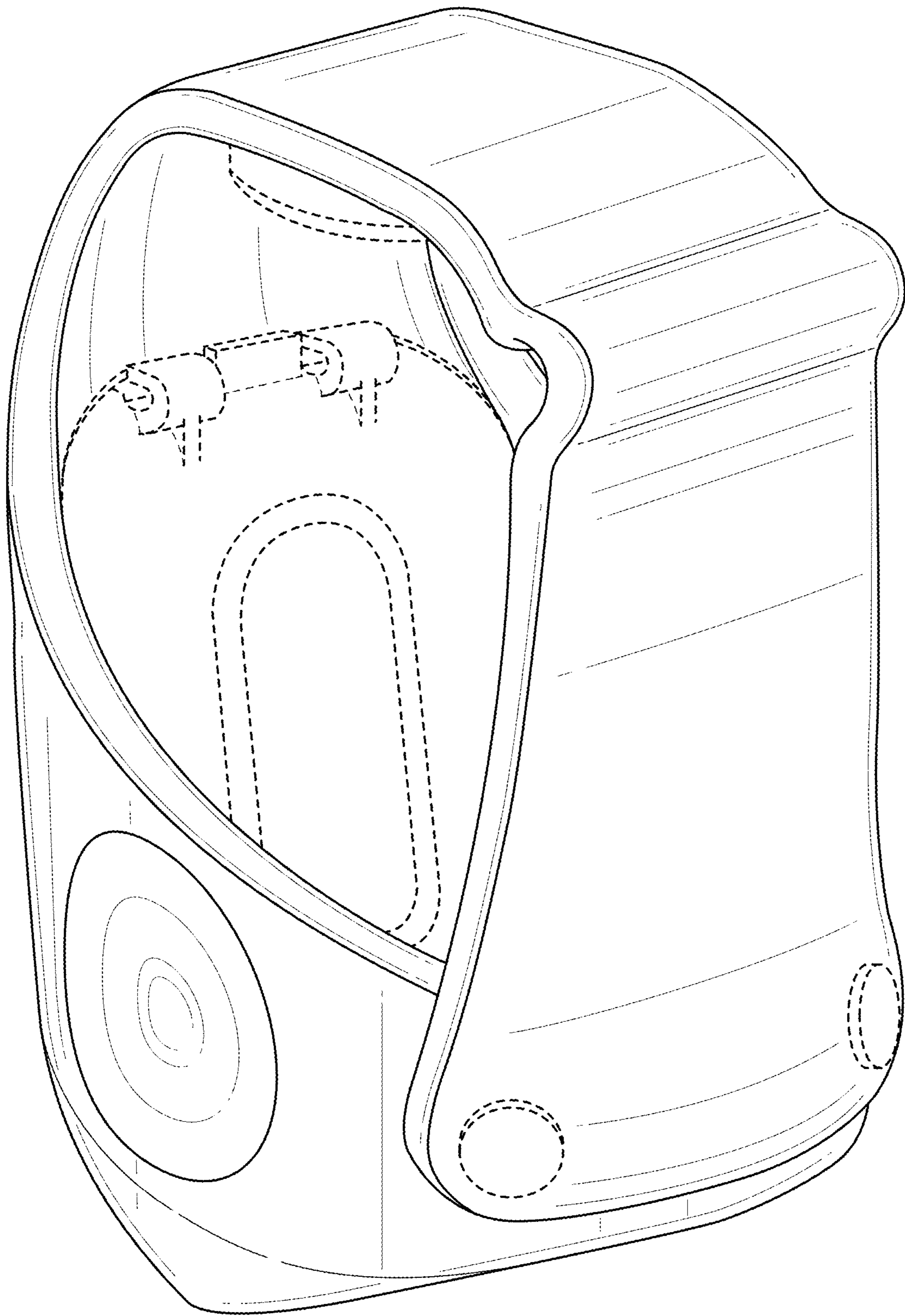

FIG. 1

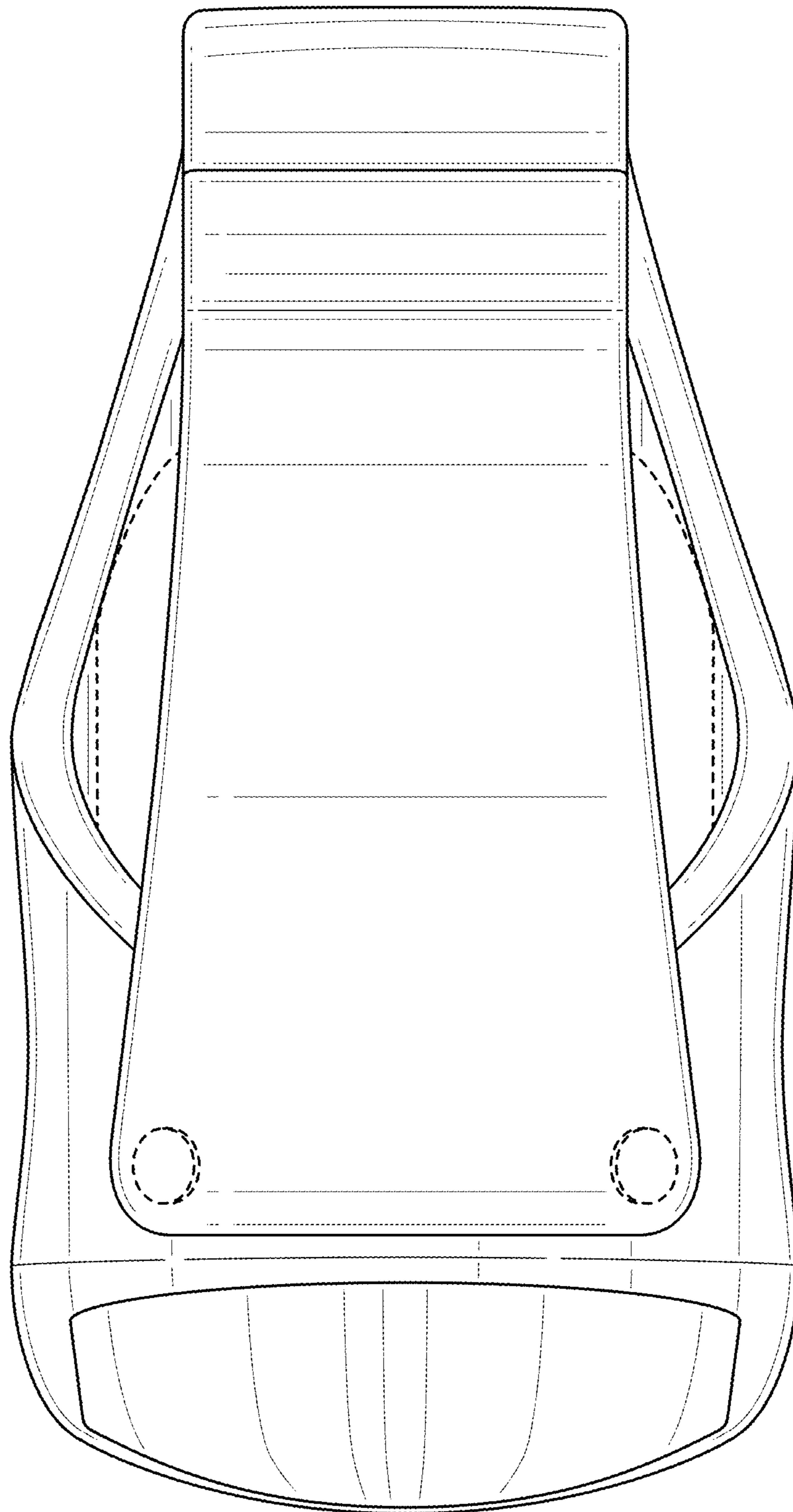

FIG. 2

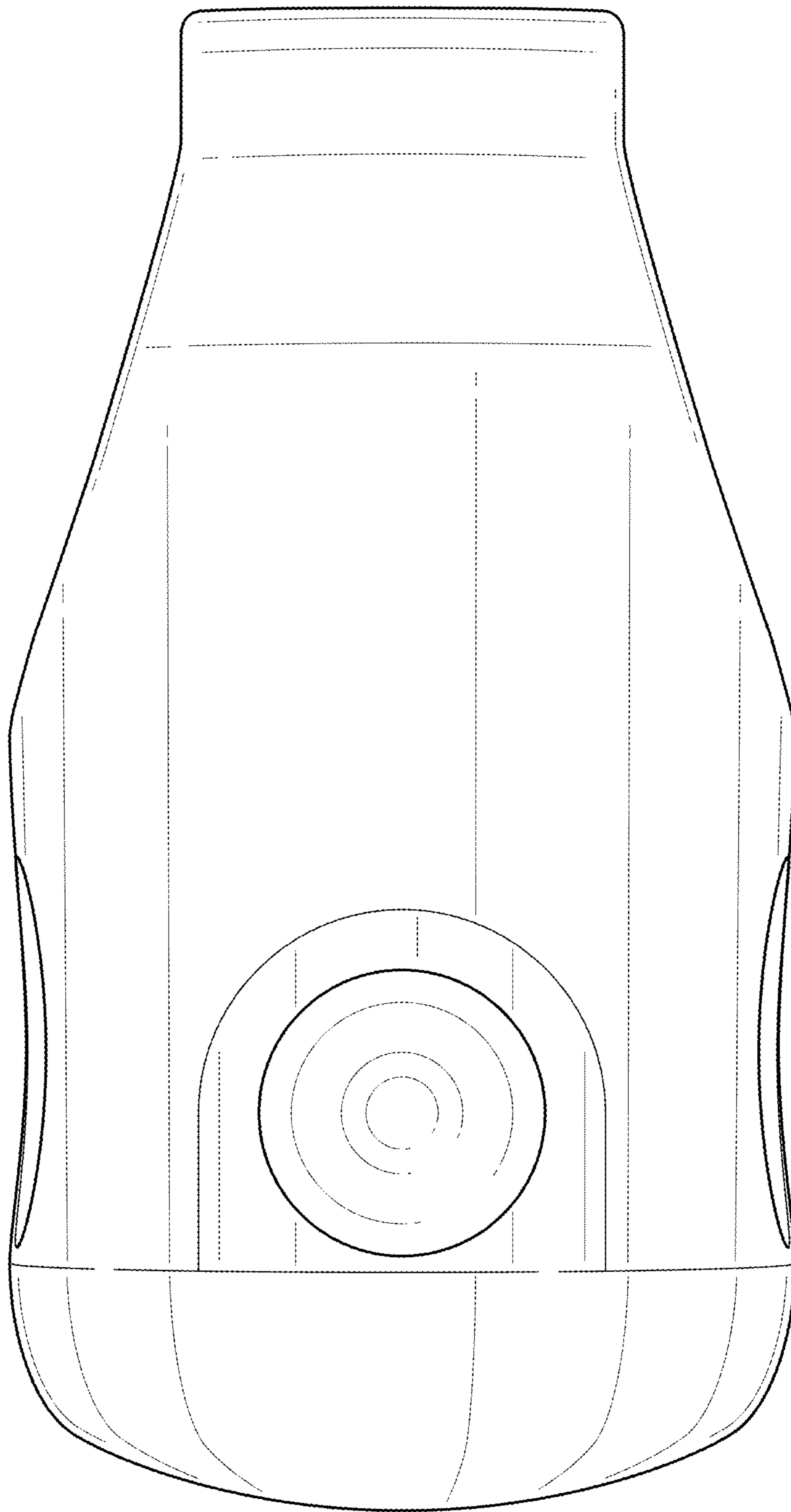

FIG. 3

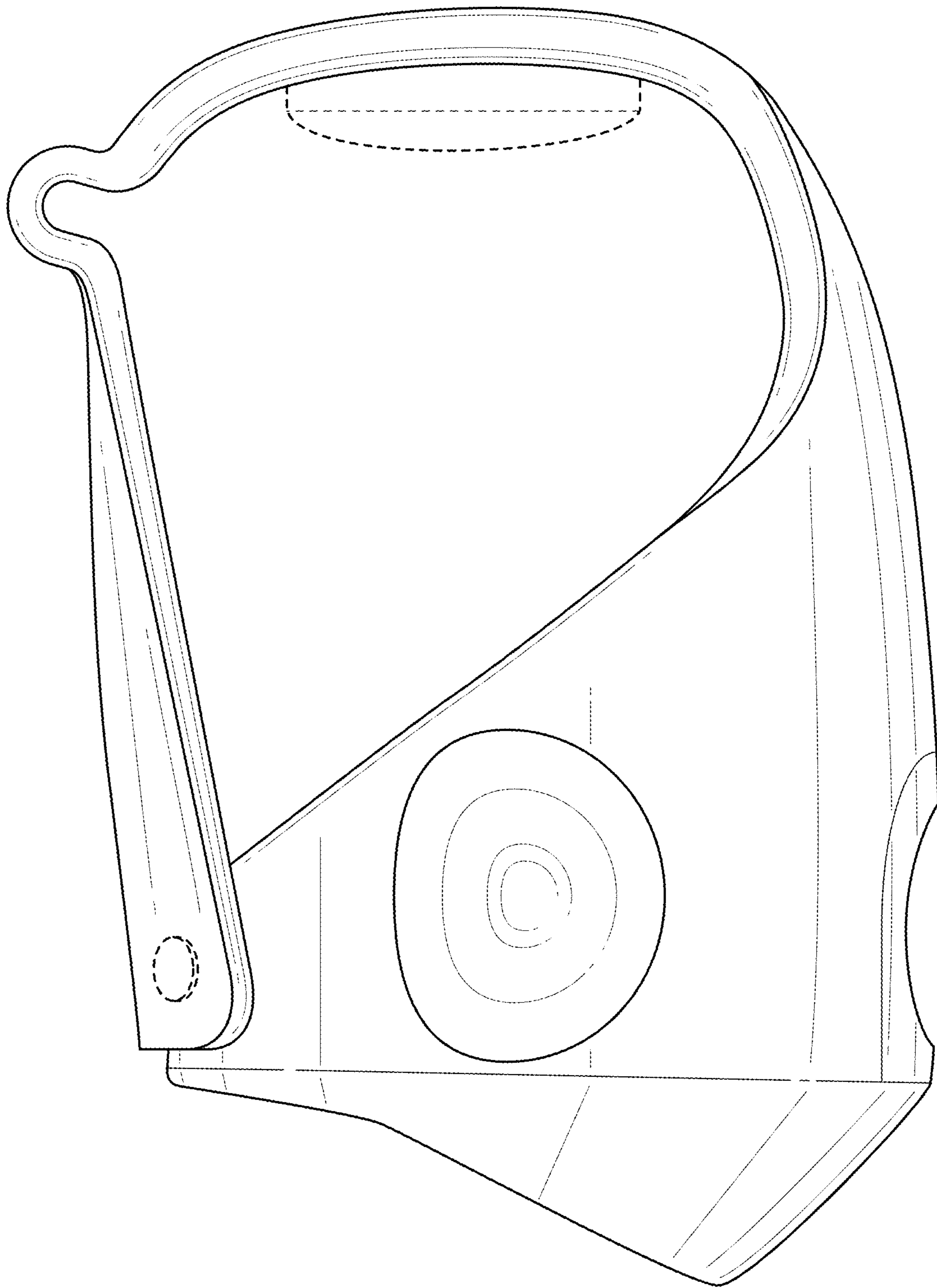

FIG. 4

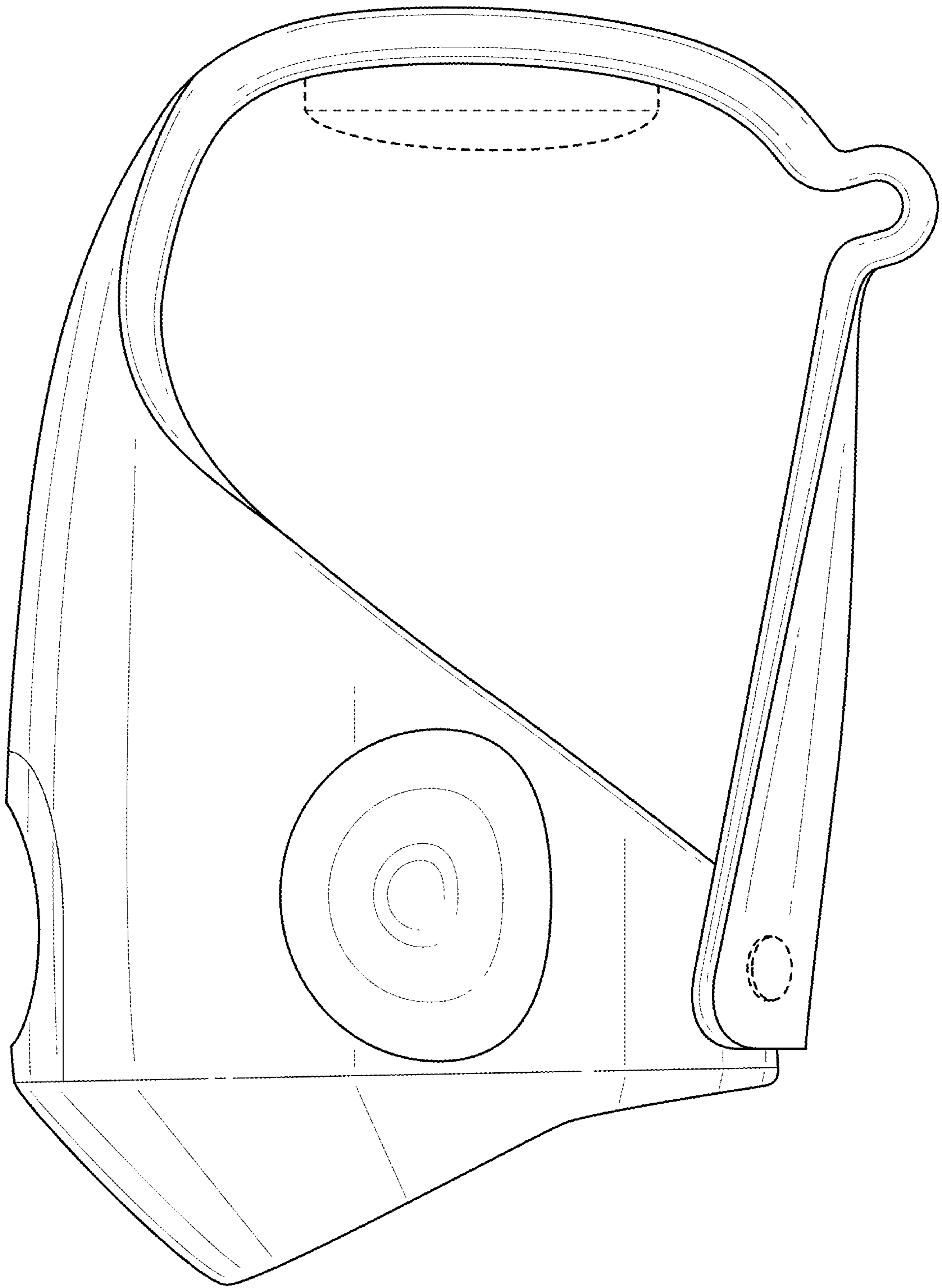

FIG. 5

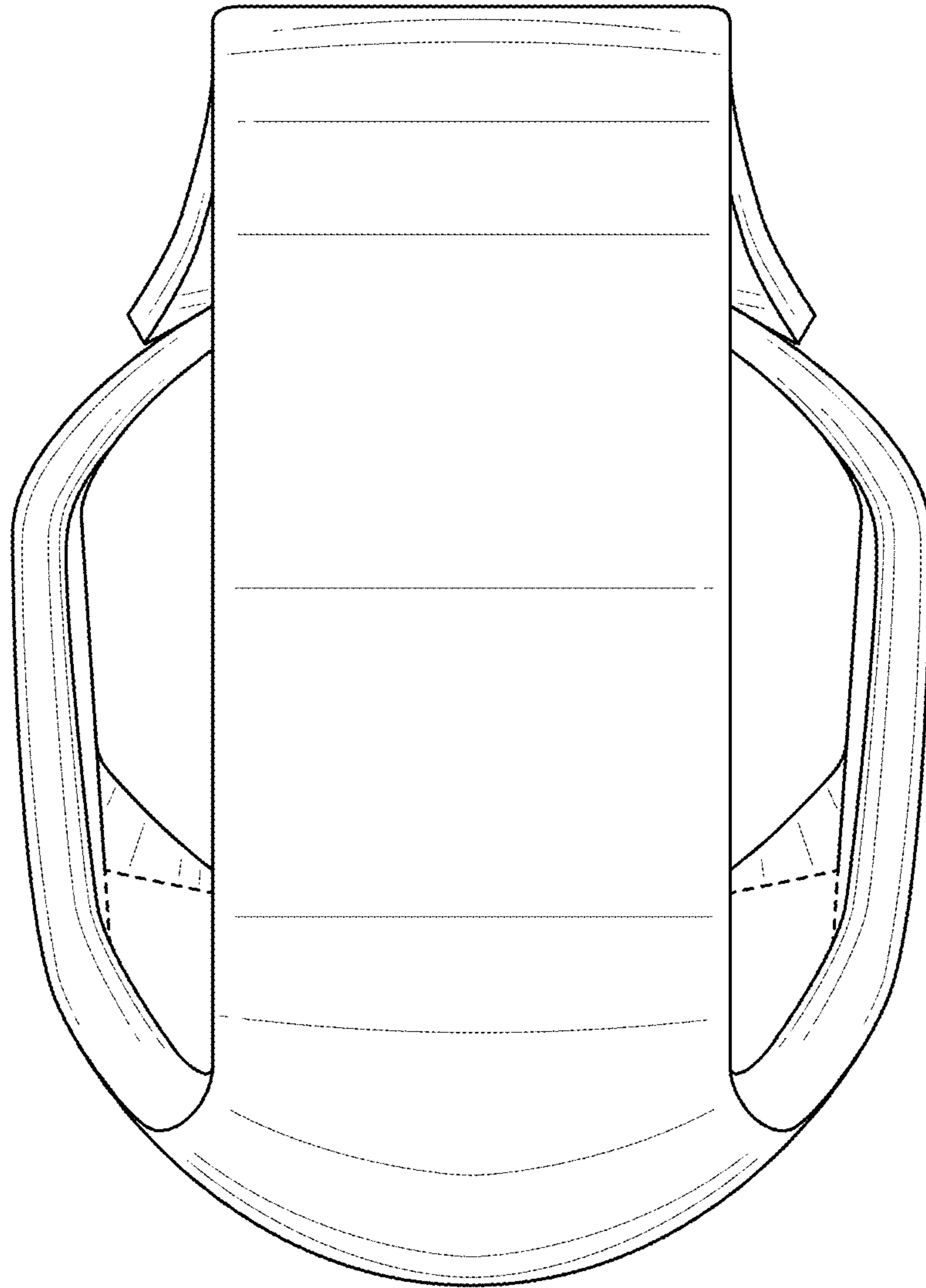

FIG. 6

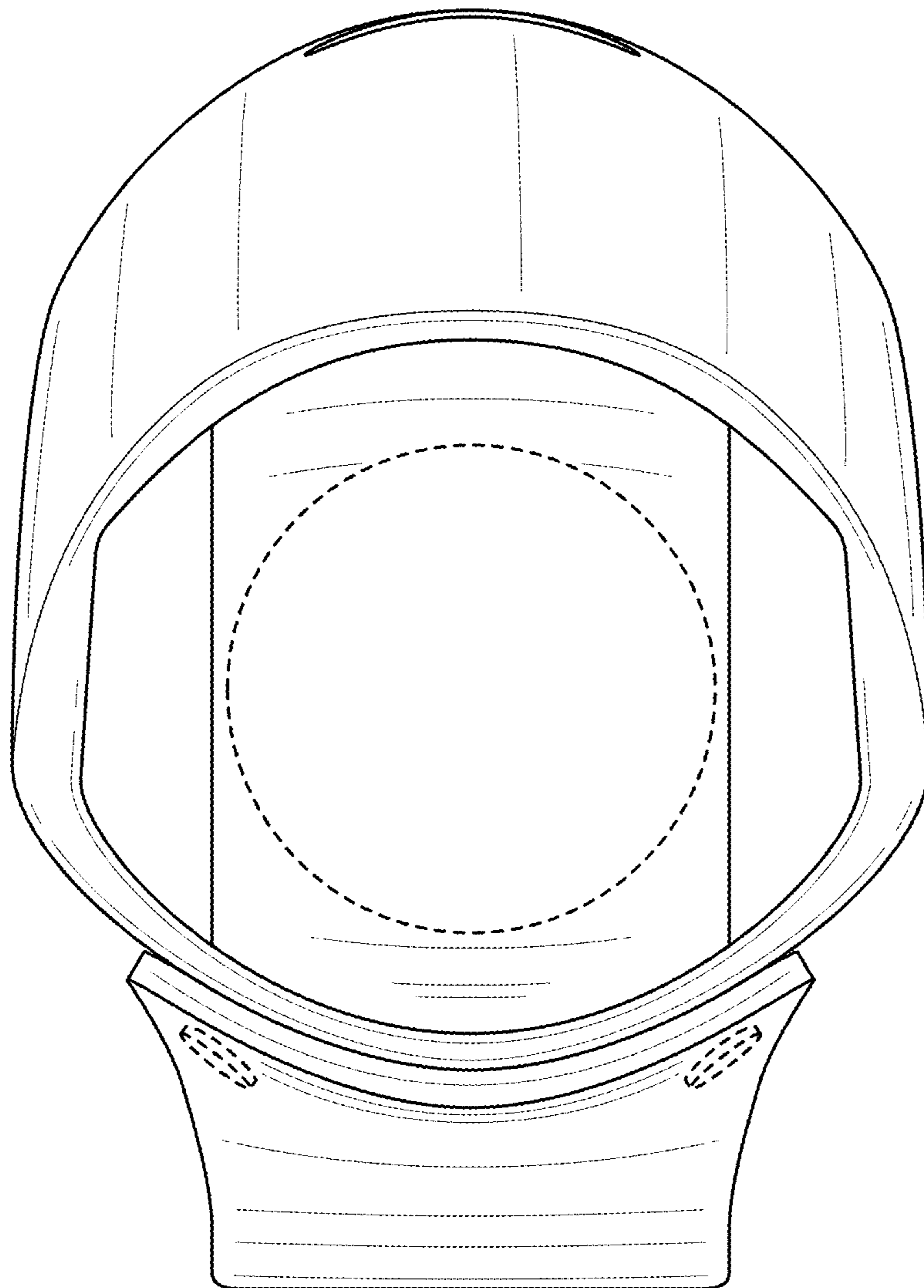

FIG. 7

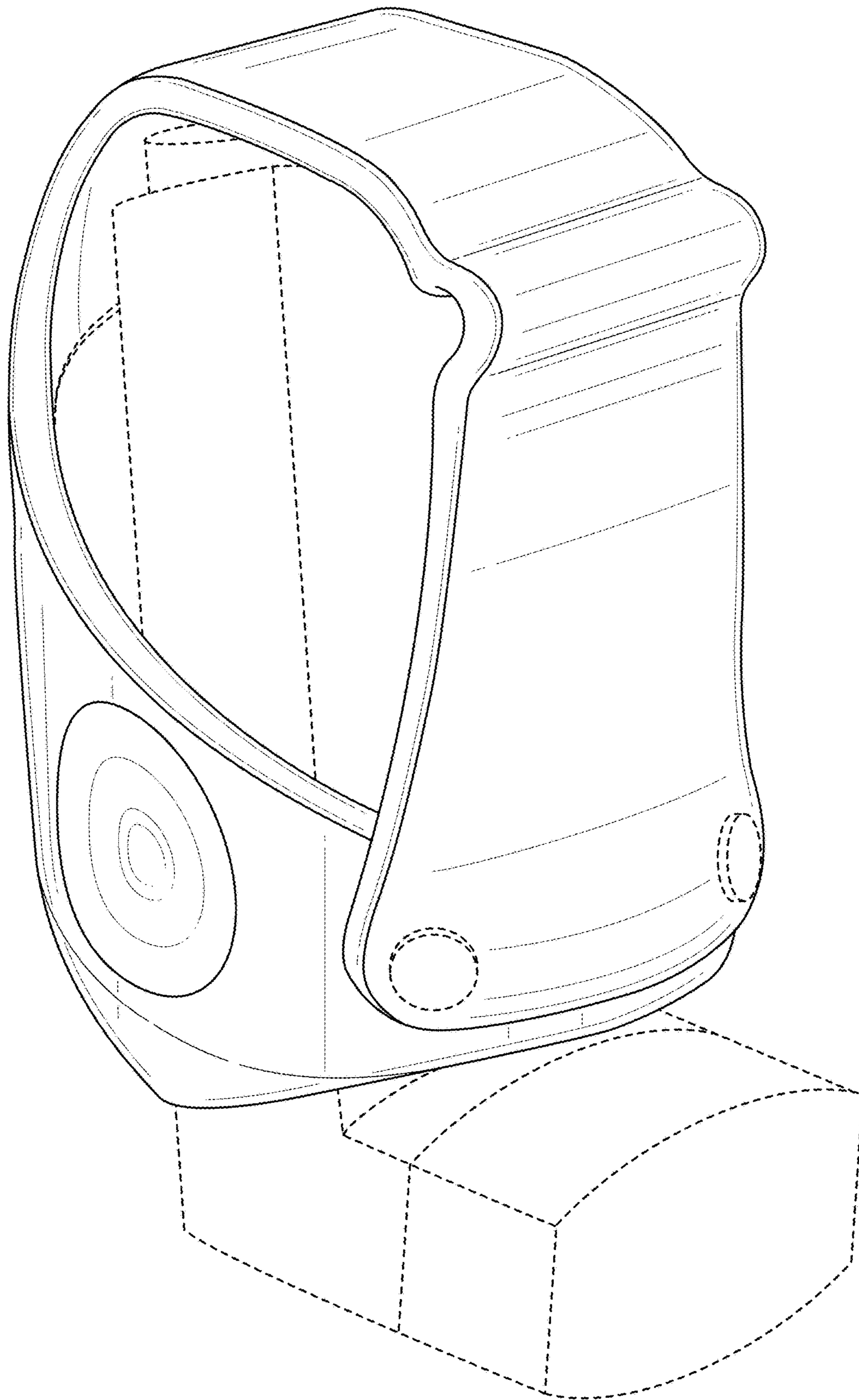

FIG. 8

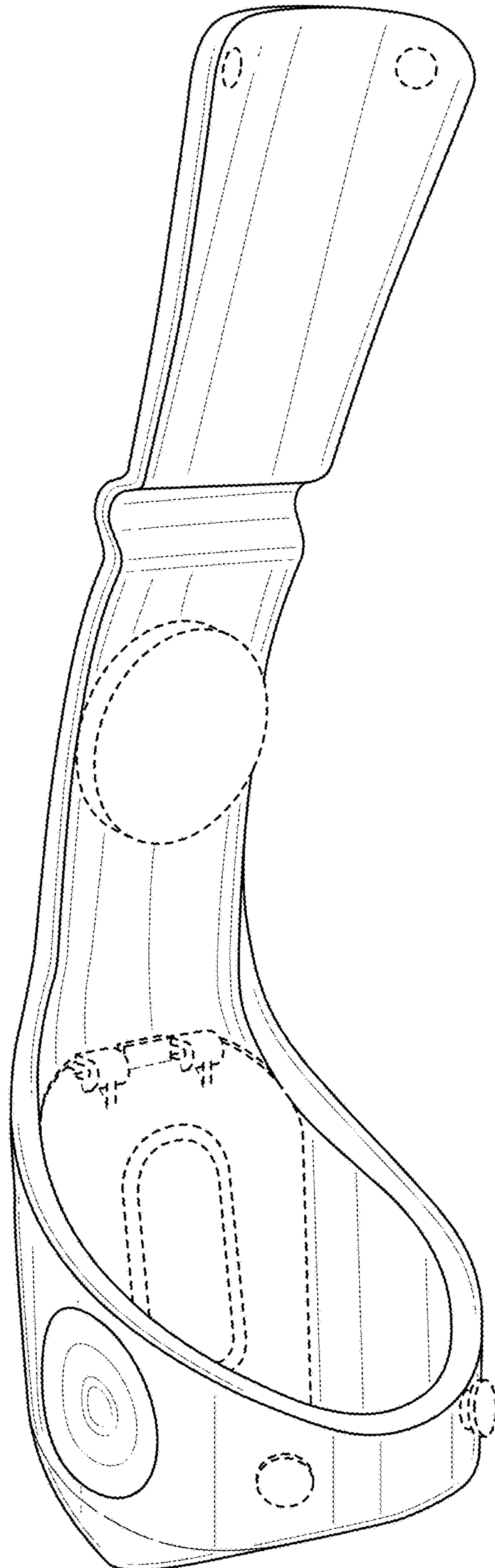

FIG. 9