



US00D787786S

(12) **United States Design Patent**  
**Lacy et al.**

(10) **Patent No.:** **US D787,786 S**  
(45) **Date of Patent:** **\*\* May 30, 2017**

(54) **FORAGE CAP**

(71) Applicant: **SUNDAY AFTERNOONS, INC.**,  
Talent, OR (US)

(72) Inventors: **Robbin Lacy**, Talent, OR (US); **Russell  
Hodgdon**, Talent, OR (US); **Gulnara  
Iskhakova**, Talent, OR (US)

(73) Assignee: **Sunday Afternoons, Inc.**, Talent, OR  
(US)

(\*\*) Term: **15 Years**

(21) Appl. No.: **29/572,293**

(22) Filed: **Jul. 26, 2016**

**Related U.S. Application Data**

(62) Division of application No. 29/497,489, filed on Jul.  
24, 2014, now Pat. No. Des. 764,150.

(51) **LOC (10) Cl.** ..... **02-03**

(52) **U.S. Cl.**  
USPC ..... **D2/882**

(58) **Field of Classification Search**  
USPC ..... D2/865, 866, 872, 873, 875, 876, 879,  
D2/882, 884, 886, 890  
CPC .... A42B 1/00; A42B 1/02; A42B 1/04; A42B  
1/041; A42B 1/06; A42B 1/061; A42B  
1/062; A42B 1/18; A42B 1/201; A42B  
1/206; A42B 1/22; A42B 1/225; A42B  
1/242; A42B 1/247; A42B 1/248  
See application file for complete search history.

(56) **References Cited**

**U.S. PATENT DOCUMENTS**

592,298 A \* 10/1897 Lattimore ..... A42B 1/248  
2/195.1  
1,156,980 A \* 10/1915 Coppers ..... A42B 1/22  
2/195.4

1,723,276 A \* 8/1929 Gottlieb ..... A63B 57/203  
2/209.13

D135,146 S \* 3/1943 Maxwell et al. .... D2/882  
D136,499 S \* 10/1943 Cookman ..... D2/882

(Continued)

**OTHER PUBLICATIONS**

Sun Tripper Cap by Sunday Afternoons, [on-line]; [video posted to  
the Internet Mar. 14, 2014]; [retrieved from the Internet Dec. 29,  
2016]; URL: <<https://www.youtube.com/watch?v=1-g-hLCVPI8>>.  
(4 pages).\*

(Continued)

*Primary Examiner* — Karen E. Eldridge Powers

*Assistant Examiner* — Jasmine Mlinarcik

(74) *Attorney, Agent, or Firm* — McCoy Russell LLP

(57)

**CLAIM**

The ornamental design for a forage cap, as shown and  
described.

**DESCRIPTION**

FIG. 1 is a front-right perspective view of a design for a  
forage cap according to the present invention;  
FIG. 2 is a top plan view thereof;  
FIG. 3 is a front elevation view thereof;  
FIG. 4 is a rear elevation view thereof;  
FIG. 5 is a rear-right perspective view thereof;  
FIG. 6 is right side elevation view thereof;  
FIG. 7 is a left side elevation view thereof;  
FIG. 8 is a bottom plan view thereof;  
FIG. 9 is a front-right perspective view thereof, showing  
example optics positioned on the forage cap; and,  
FIG. 10 is a rear elevation view thereof, showing example  
optics positioned on the forage cap.  
The broken lines shown as part of the cap itself illustrate  
features of the article of manufacture that form no part of the  
claimed design. The broken lines illustrating optics repre-  
sent environmental structure that forms no part of the  
claimed design.

**1 Claim, 10 Drawing Sheets**

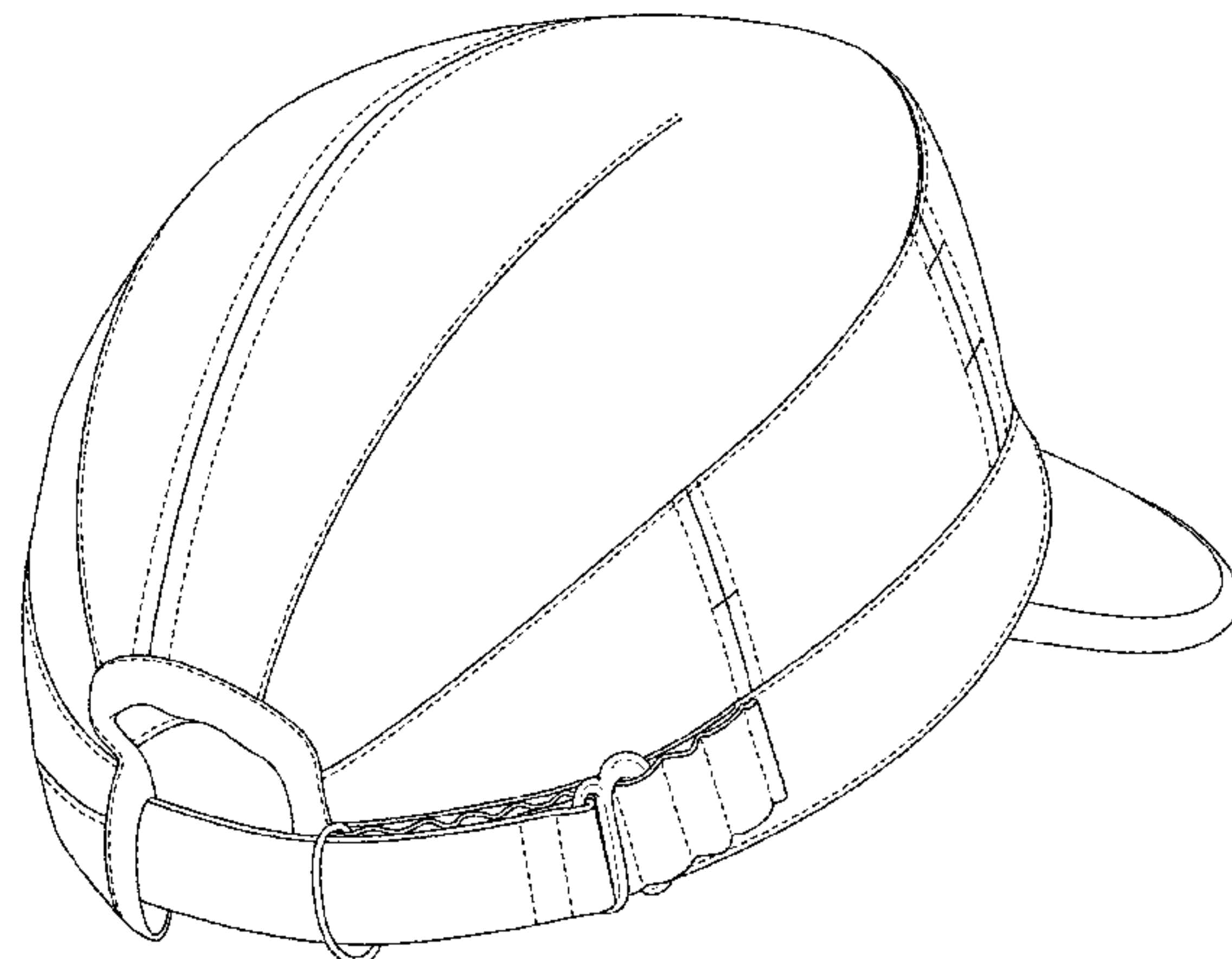
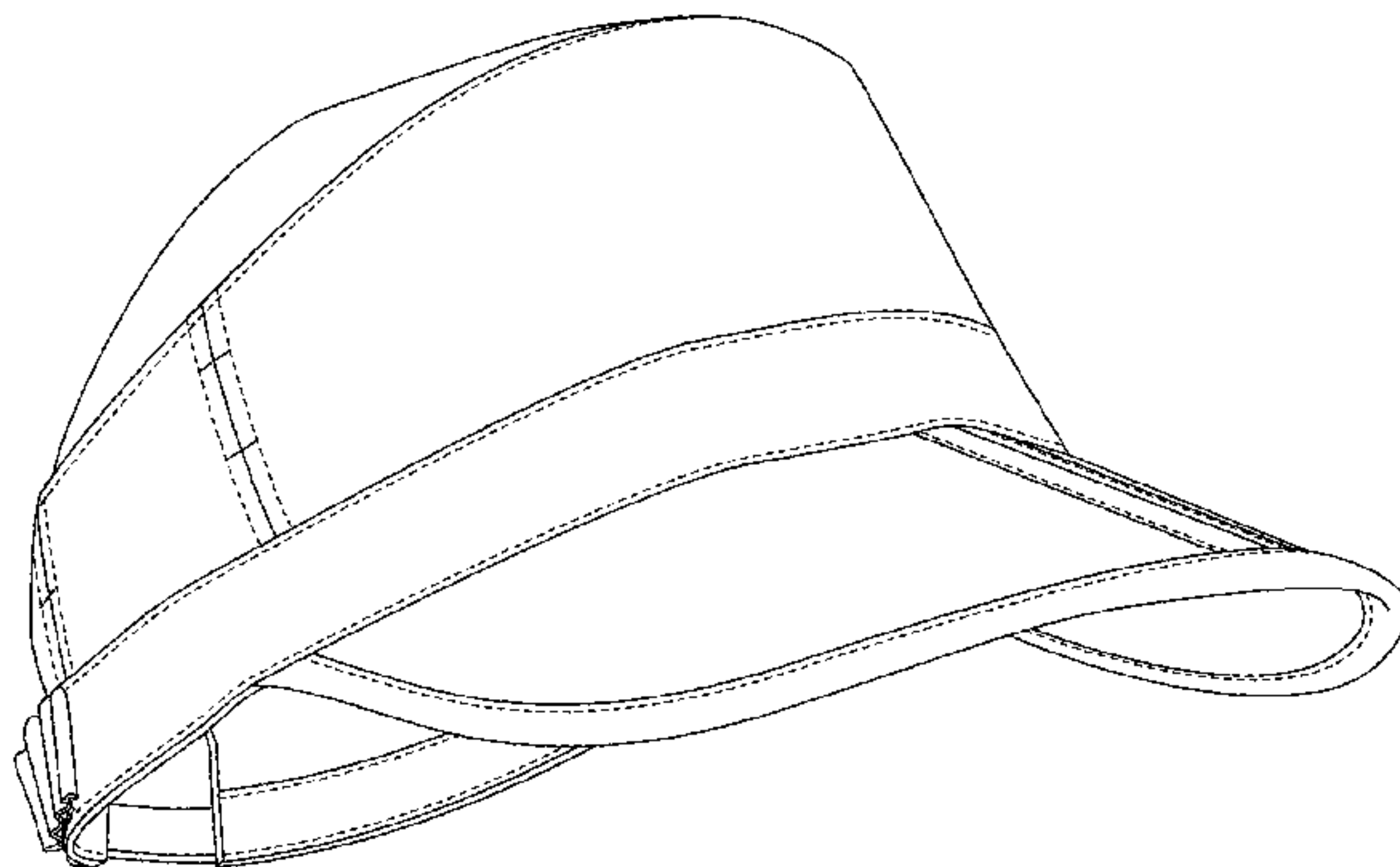

(56)

References Cited

U.S. PATENT DOCUMENTS

D178,682 S \* 9/1956 Lipschutz ..... D2/882  
 D186,868 S \* 12/1959 De Grazia ..... D2/882  
 D289,700 S \* 5/1987 Burns ..... D2/884  
 D364,494 S \* 11/1995 Sisera ..... D2/869  
 D384,489 S \* 10/1997 Ethier ..... D2/866  
 D388,240 S \* 12/1997 Martz ..... D2/884  
 5,845,338 A \* 12/1998 Clark ..... A42B 1/206  
 2/171.1  
 D423,196 S \* 4/2000 White ..... D2/882  
 6,167,569 B1 \* 1/2001 Conner, IV ..... A42B 1/006  
 2/195.1  
 D439,728 S \* 4/2001 Smith ..... D2/866  
 D450,173 S \* 11/2001 Allen ..... D2/866  
 6,357,051 B1 \* 3/2002 Lee ..... A42B 1/201  
 2/195.1  
 6,446,266 B1 \* 9/2002 Park ..... A42B 1/22  
 2/175.1  
 D491,714 S \* 6/2004 Upcott ..... D2/875  
 7,275,270 B2 \* 10/2007 Cotutsca ..... A42B 1/247  
 2/209.13  
 D603,586 S \* 11/2009 Miller ..... D2/882  
 D616,633 S \* 6/2010 Lacy ..... D2/882  
 7,904,970 B2 \* 3/2011 Thomas ..... A42B 1/247  
 2/195.6  
 D636,976 S \* 5/2011 McIntosh ..... D2/882

D672,119 S \* 12/2012 Mayleben ..... D2/882  
 D673,352 S \* 1/2013 Robinson ..... D2/876  
 D678,663 S \* 3/2013 Gill ..... D2/882  
 D683,111 S \* 5/2013 Rogers ..... D2/876  
 D691,349 S \* 10/2013 Pearson ..... D2/882  
 D718,021 S \* 11/2014 Werczberger ..... D2/882  
 D723,249 S \* 3/2015 Azam ..... D2/882  
 D764,150 S \* 8/2016 Lacy ..... D2/882  
 2002/0095715 A1 \* 7/2002 Hong ..... A42B 1/06  
 2/209.11  
 2003/0233696 A1 \* 12/2003 Lee ..... A42B 1/22  
 2/195.2  
 2015/0351478 A1 \* 12/2015 Yurevich ..... A42B 1/247  
 2/209.13  
 2016/0021962 A1 \* 1/2016 Lacy ..... A42B 1/201  
 2/181

OTHER PUBLICATIONS

River Tripper Cap, [on-line]; [video posted to the Internet Jun. 30, 2015]; [retrieved from the Internet Dec. 29, 2016]; URL: <<https://www.youtube.com/watch?v=2CMv6frkoIE>>. (5 pages).\*

Sun Tripper Cap, [on-line]; [posted to the Internet with a crawlback date of Oct. 5, 2012]; [retrieved from the Internet Dec. 29, 2016]; URL: <<https://web.archive.org/web/20121005075246/http://www.sundayafternoons.com/sun-tripper-cap.html>>. (1 page).\*

\* cited by examiner

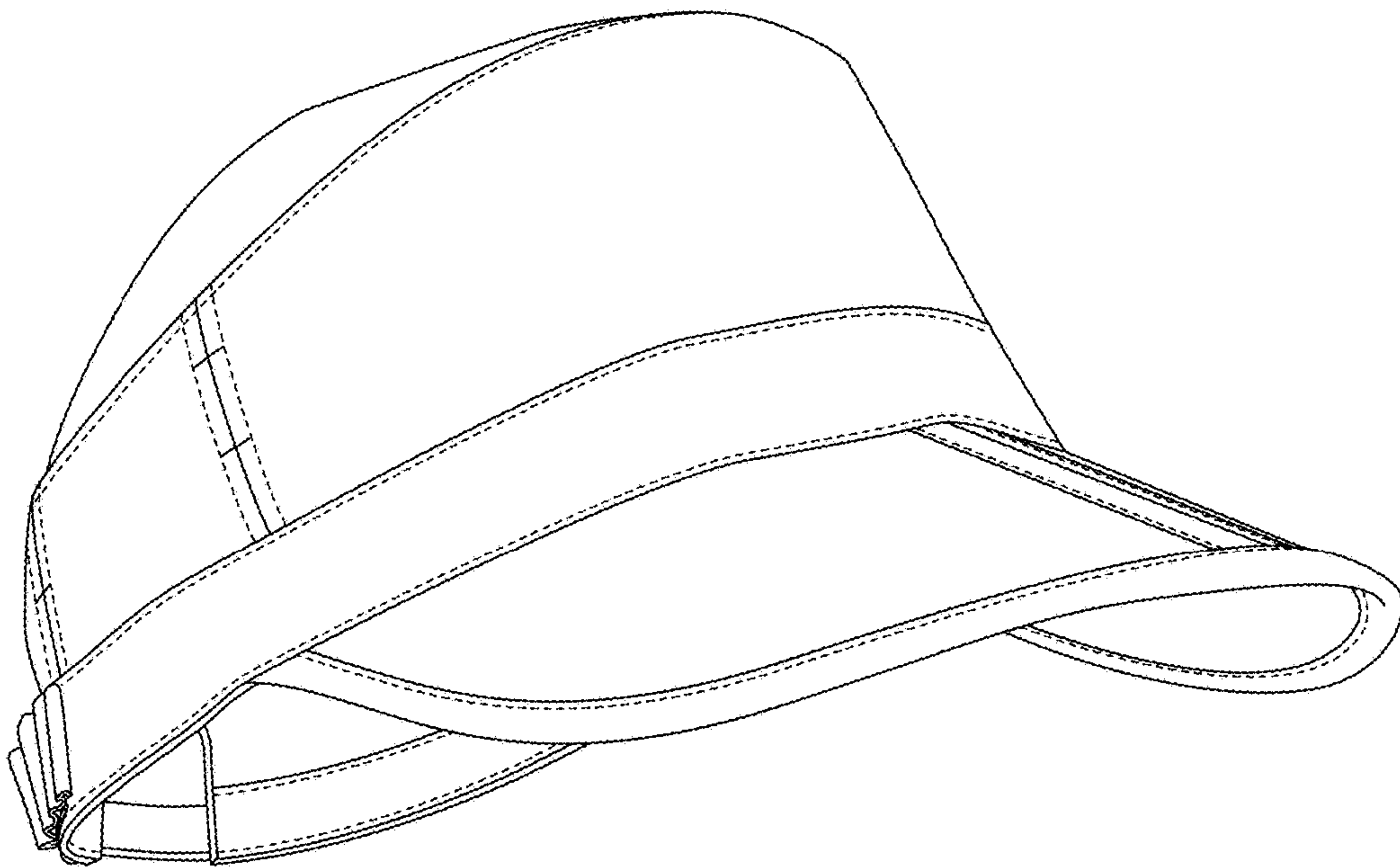

FIG. 1

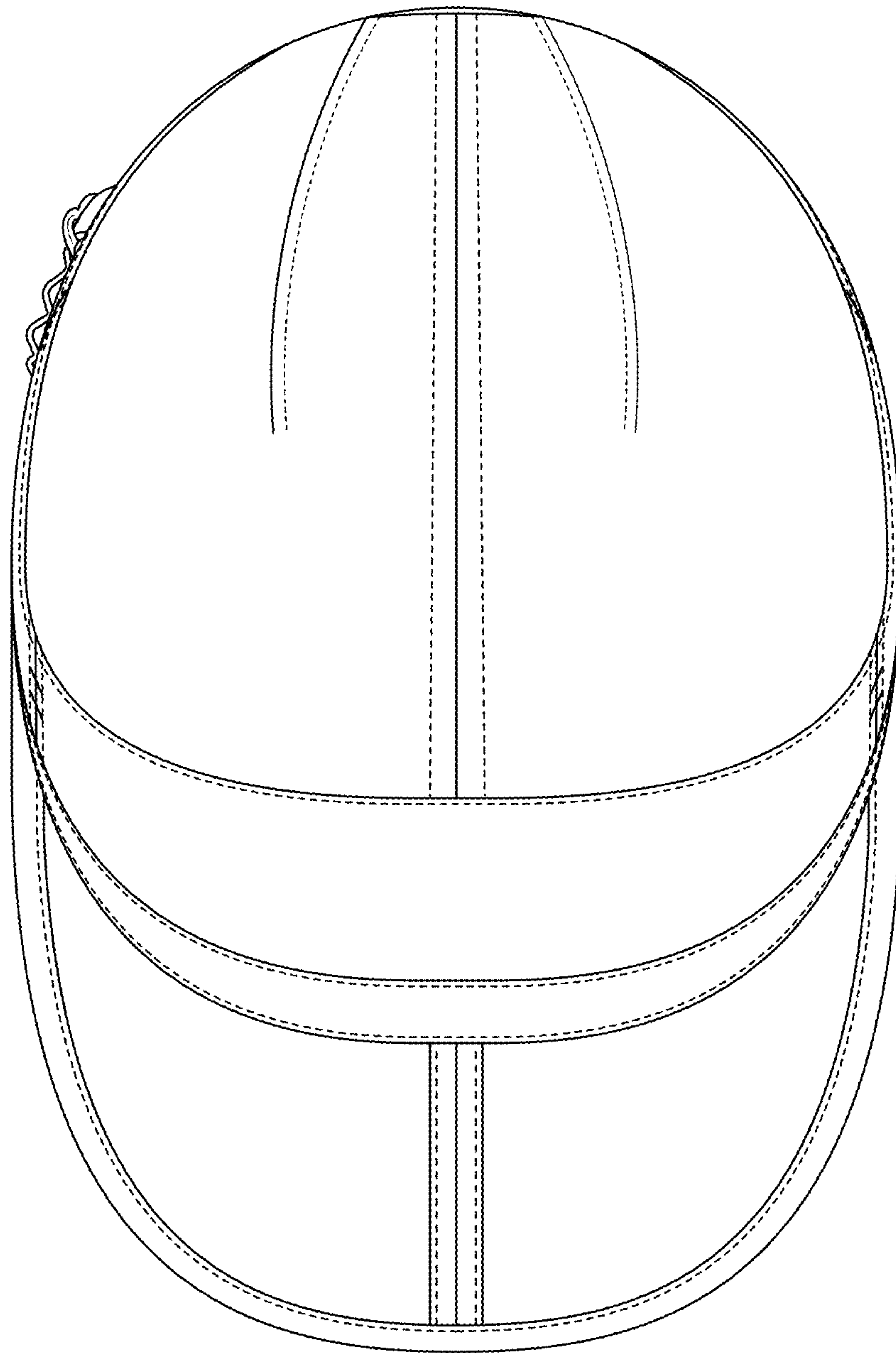

FIG. 2



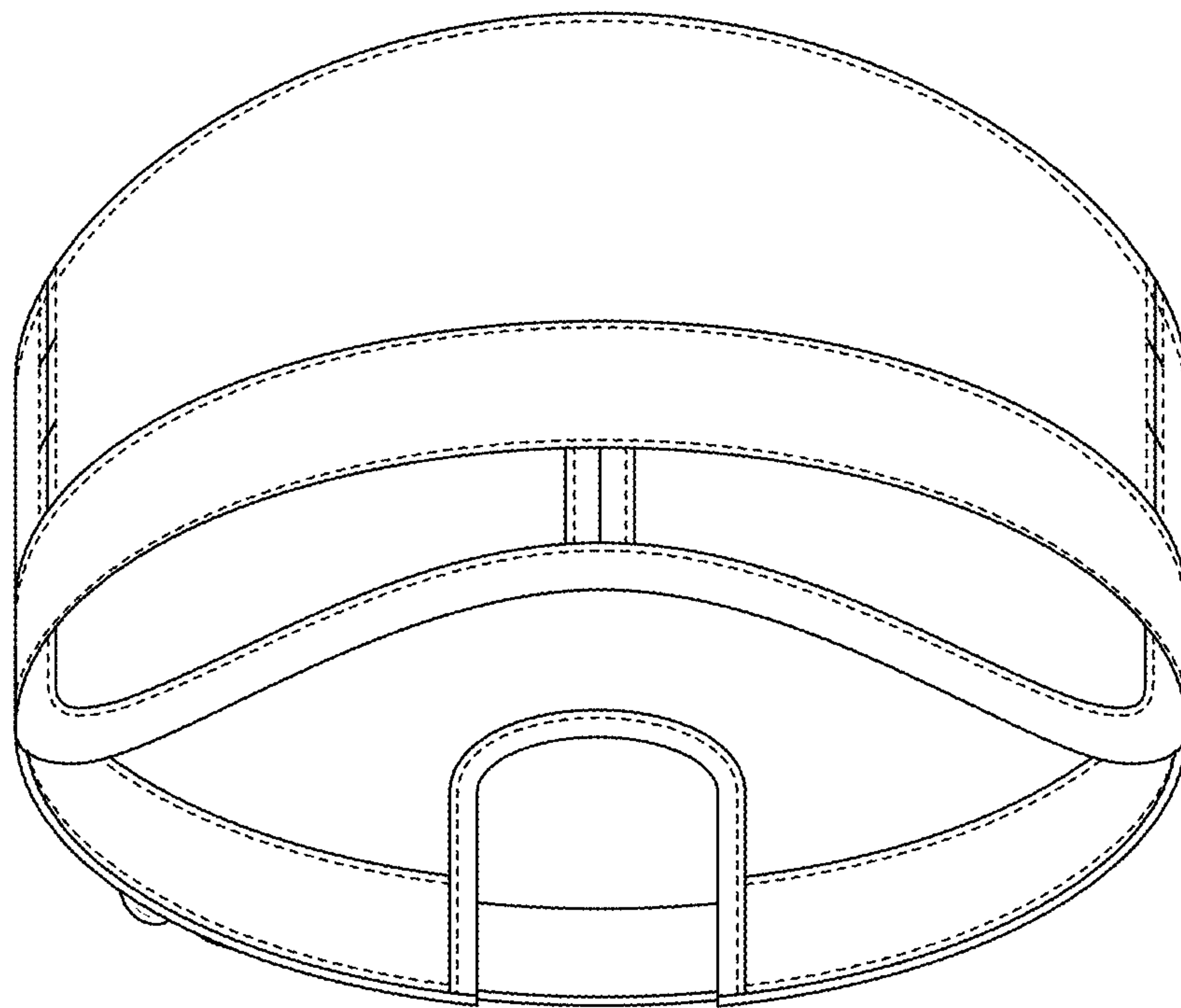

FIG. 3

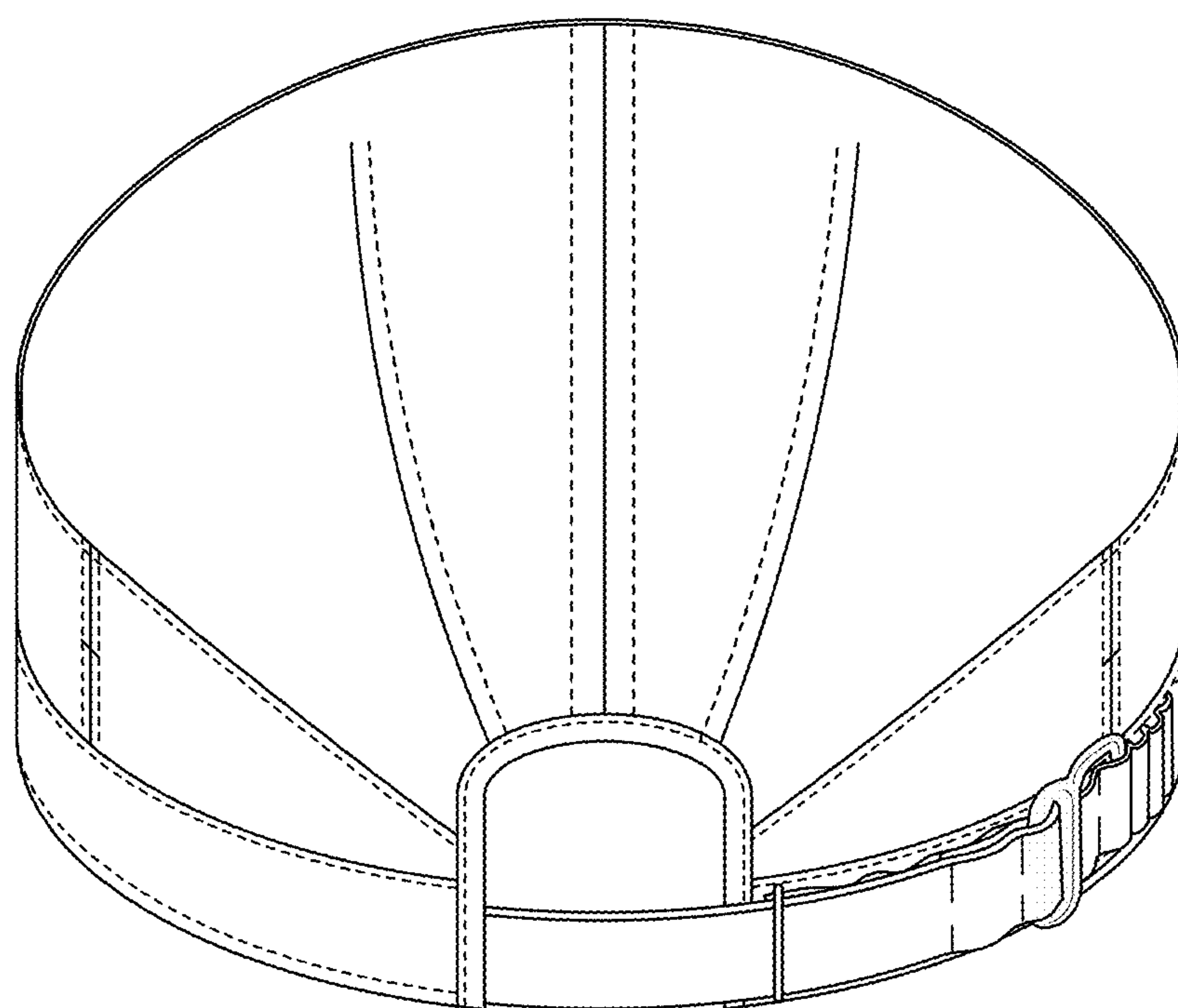

FIG. 4

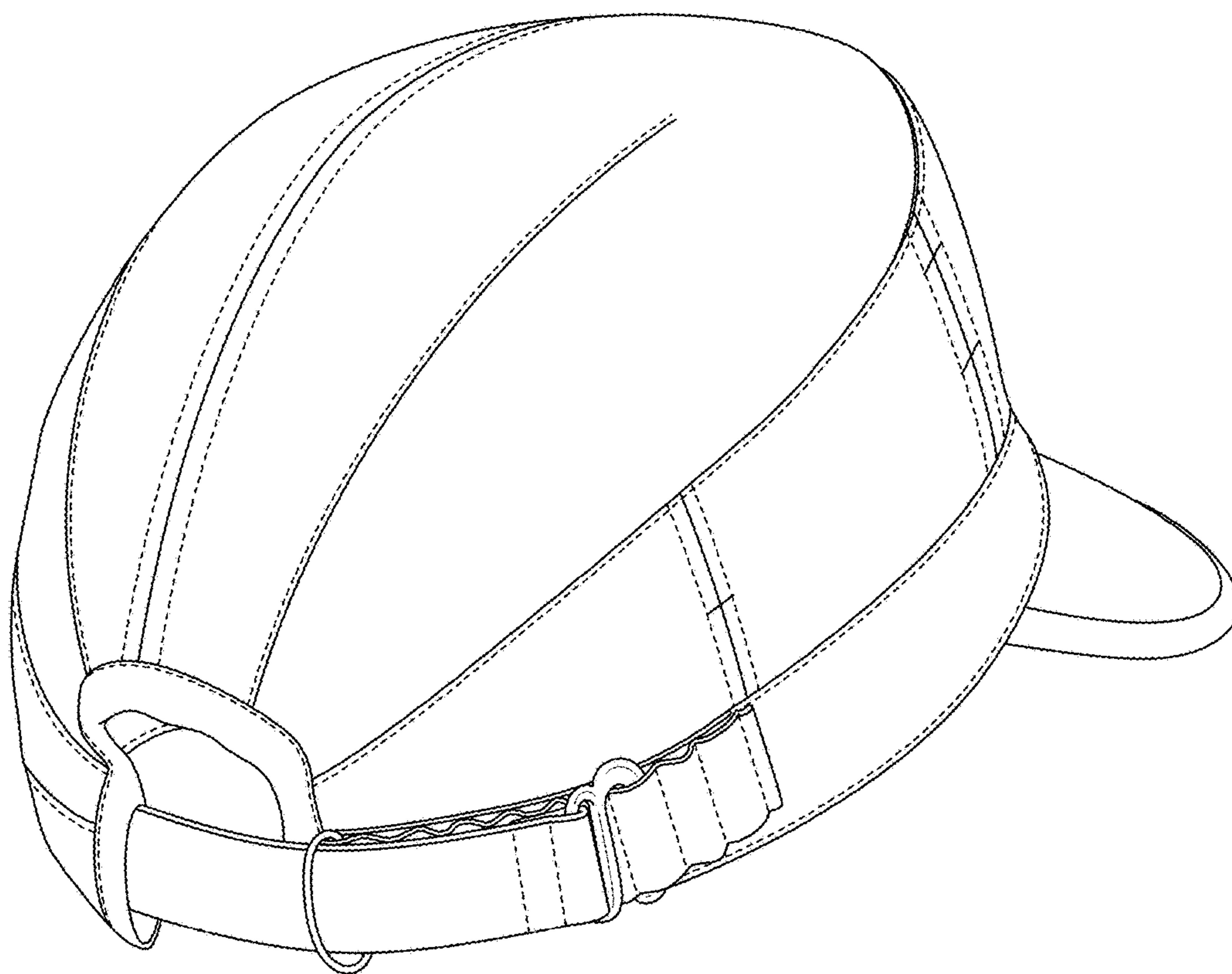

FIG. 5

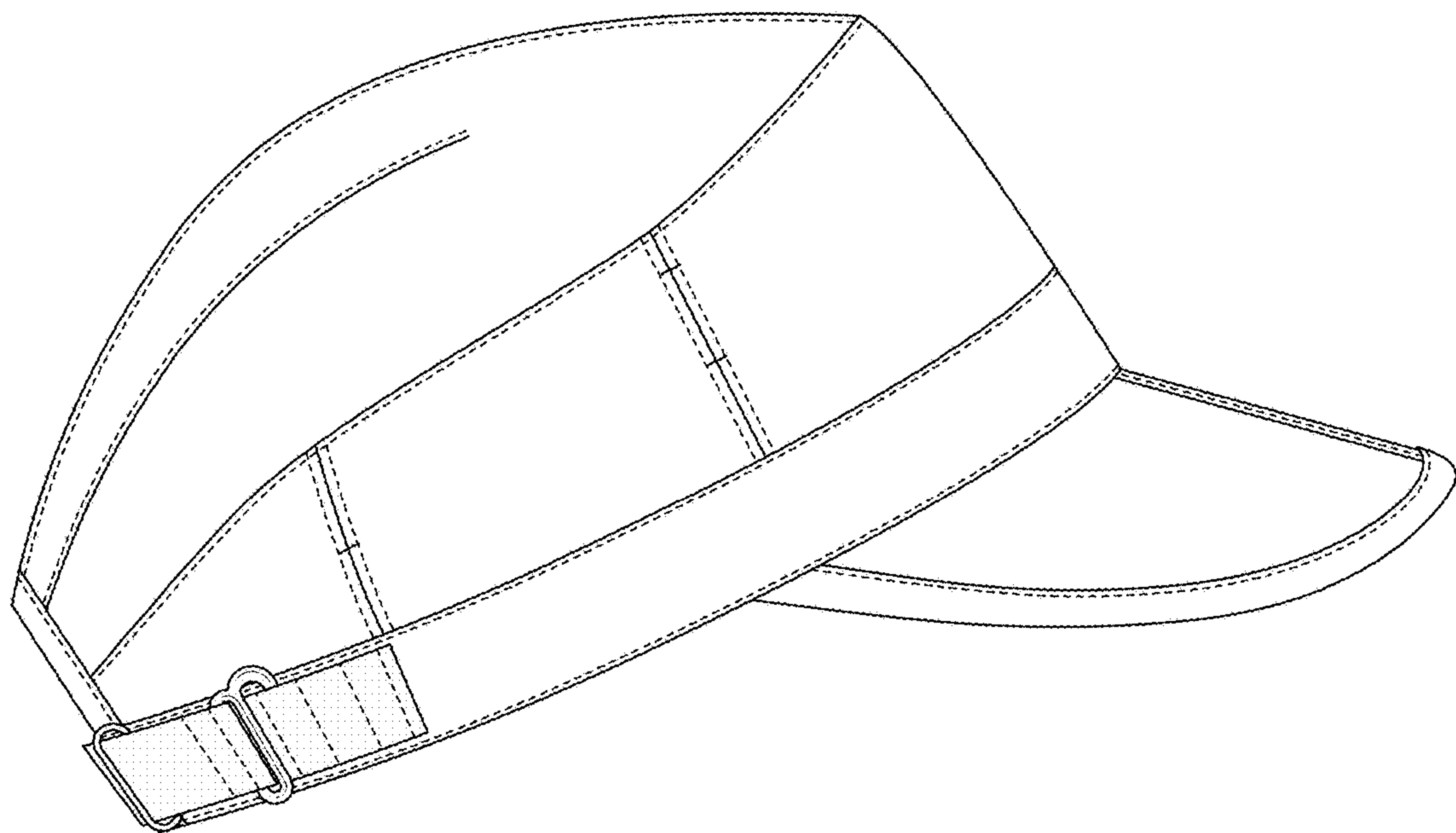

FIG. 6



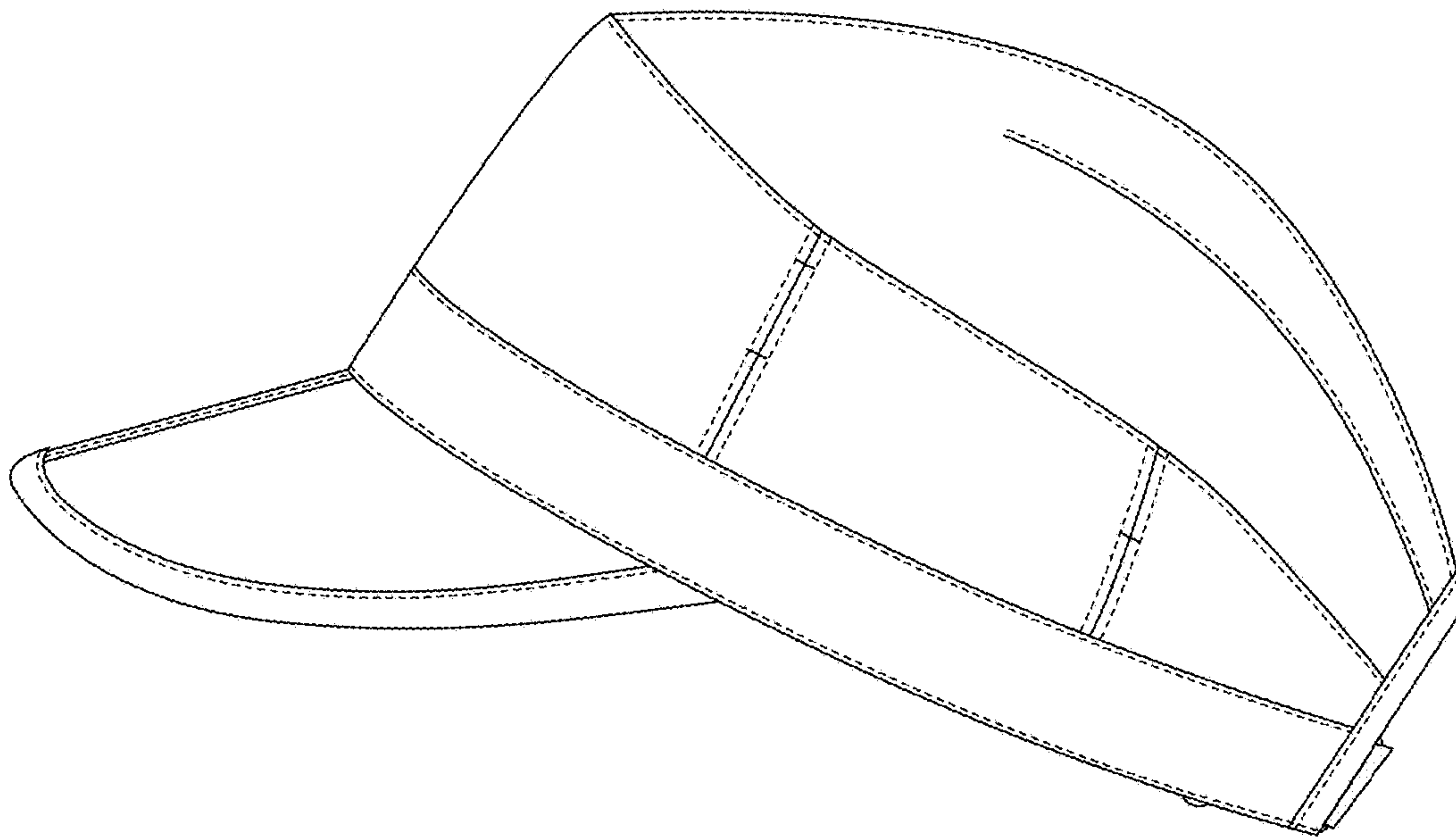

FIG. 7

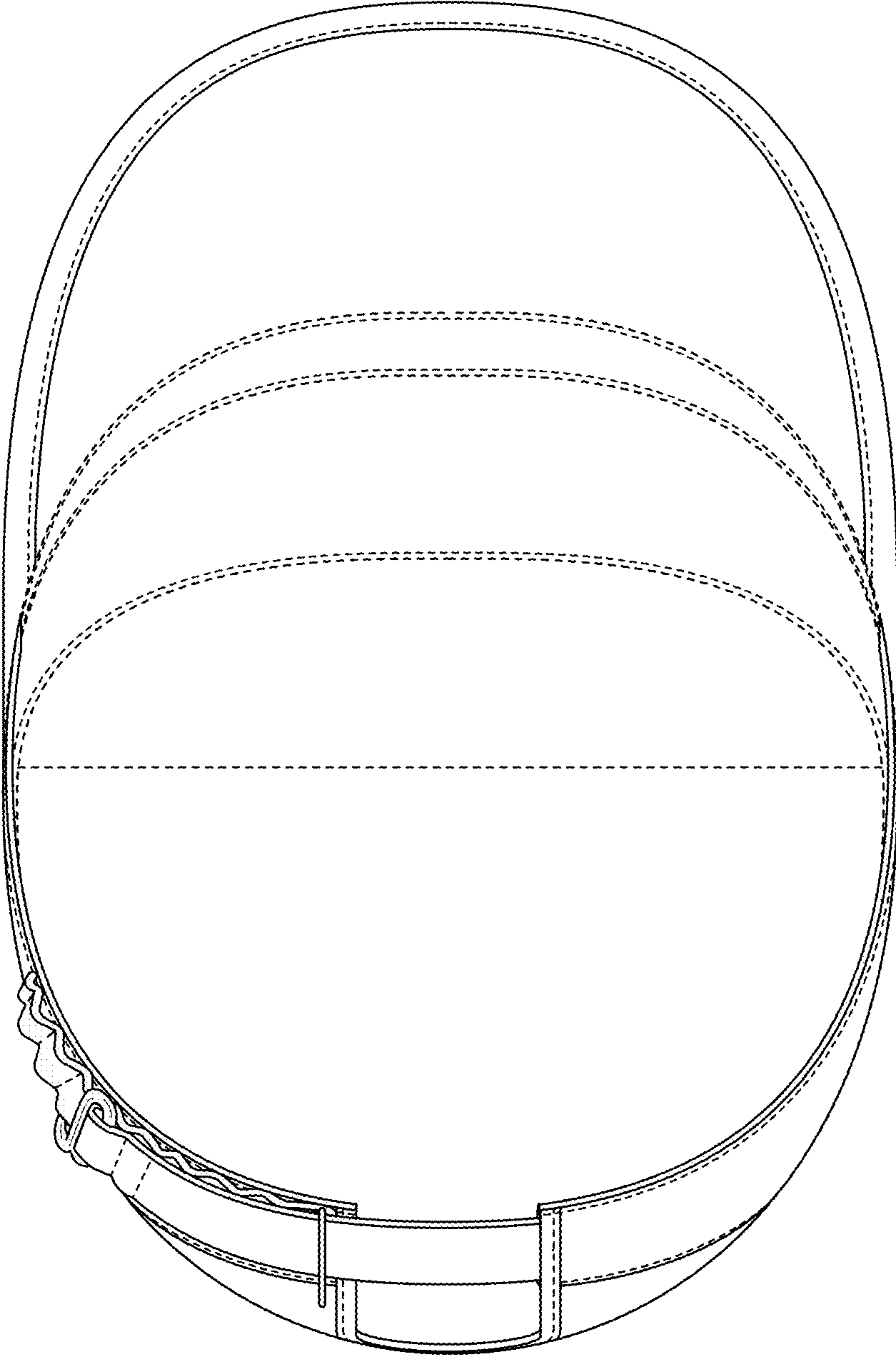

FIG. 8

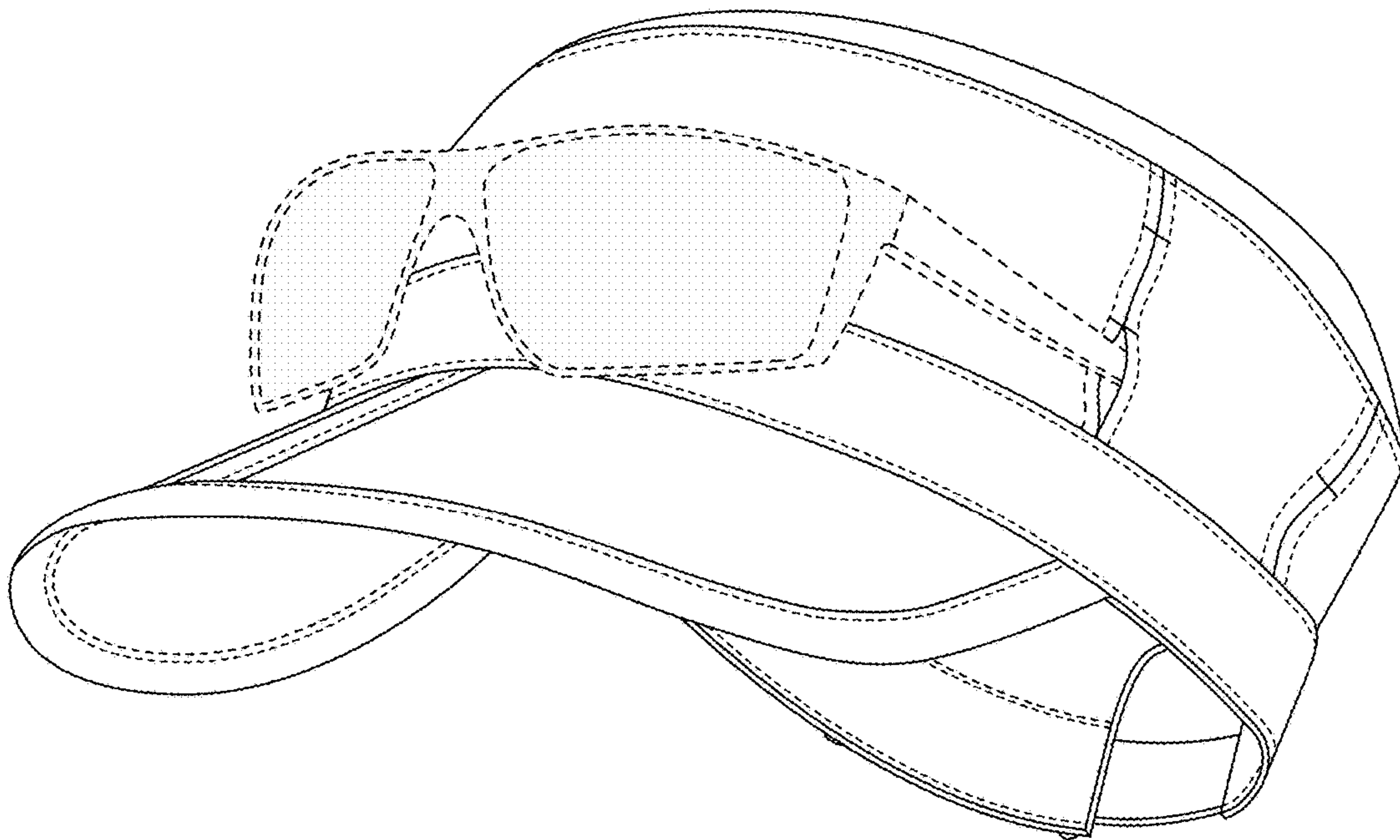

FIG. 9

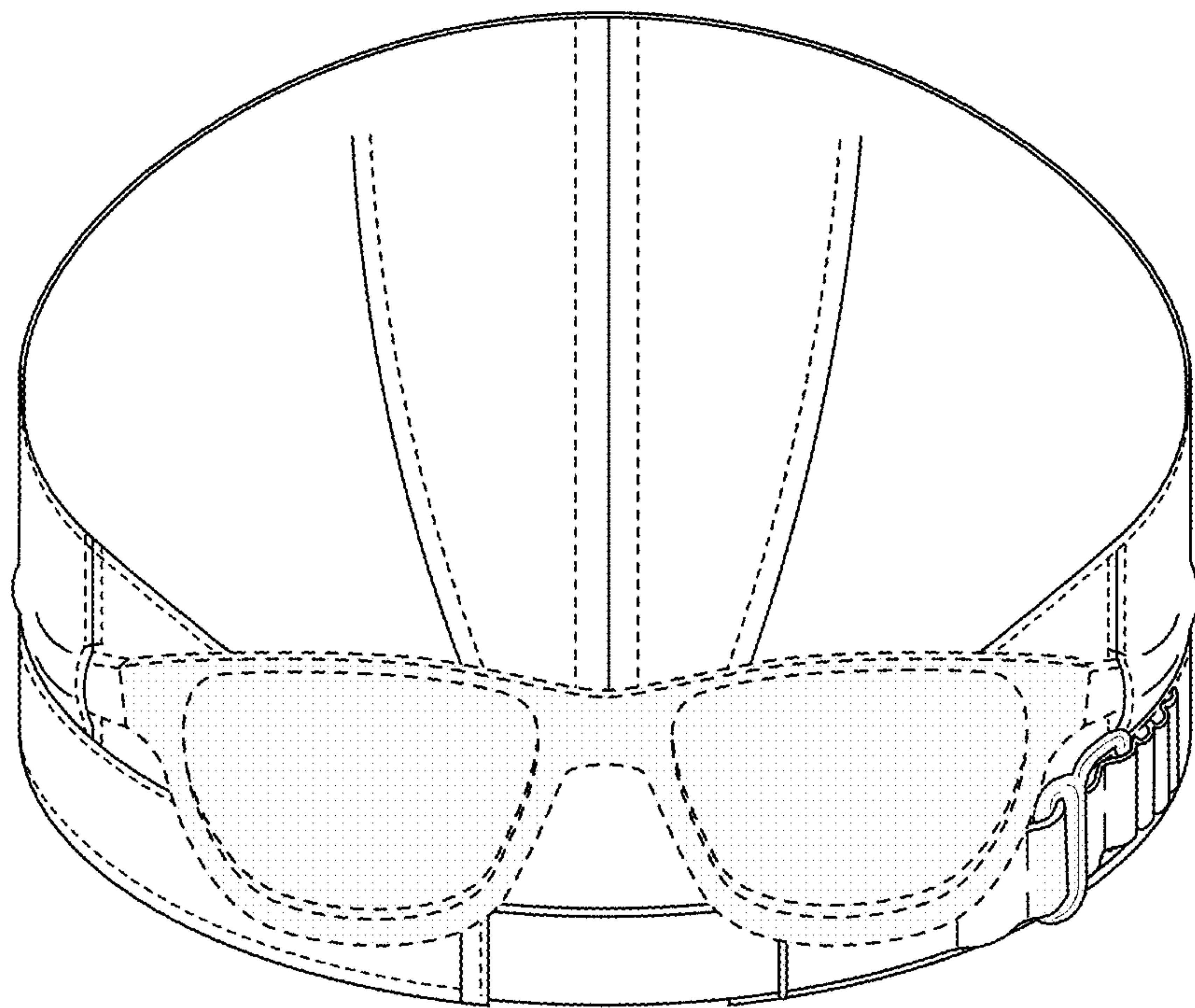

FIG. 10