



US00D787745S

(12) **United States Design Patent**
Lamballais

(10) **Patent No.:** **US D787,745 S**

(45) **Date of Patent:** **** May 23, 2017**

(54) **HAIR DRYER**

(71) Applicant: **Velecta Paramount**, Paris (FR)

(72) Inventor: **Laurent Lamballais**, Sene (FR)

(73) Assignee: **VELECTA PARAMOUNT**, Paris (FR)

(**) Term: **14 Years**

(21) Appl. No.: **29/523,797**

(22) Filed: **Apr. 14, 2015**

(30) **Foreign Application Priority Data**

Oct. 15, 2014 (EM) 002557876-0001
Oct. 15, 2014 (EM) 002557876-0002

(51) **LOC (10) Cl.** **28-03**

(52) **U.S. Cl.**
USPC **D28/13**

(58) **Field of Classification Search**

USPC D28/12-19; 34/96-101; 392/380-385;
219/222
CPC A45D 20/12; A45D 20/00
See application file for complete search history.

(56) **References Cited**

U.S. PATENT DOCUMENTS

D543,313 S * 5/2007 Petruccelli, Jr. D28/13
D627,510 S * 11/2010 Zabala D28/13

D629,967 S * 12/2010 Mayo D28/13
D641,521 S * 7/2011 Parodi D28/13
D681,274 S * 4/2013 Huang D28/13
D681,275 S * 4/2013 Huang D28/13
D697,667 S * 1/2014 Yoe D28/13

* cited by examiner

Primary Examiner — **Zenia Bennett**

(74) *Attorney, Agent, or Firm* — **Additon, Higgins & Pendleton, P.A.**

(57) **CLAIM**

The ornamental design for a hair dryer, as shown and described.

DESCRIPTION

FIG. 1 is a left side view of a hair dryer showing my new design;
FIG. 2 is a right side view of the hair dryer of FIG. 1;
FIG. 3 is a front view of the hair dryer of FIG. 1;
FIG. 4 is rear view of the hair dryer of FIG. 1;
FIG. 5 is a front perspective view of the hair dryer of FIG. 1; and,
FIG. 6 is a rear perspective view of the hair dryer of FIG. 1.
The intended use of the hair dryer is drying hair and/or styling hair, including human hair.

1 Claim, 6 Drawing Sheets

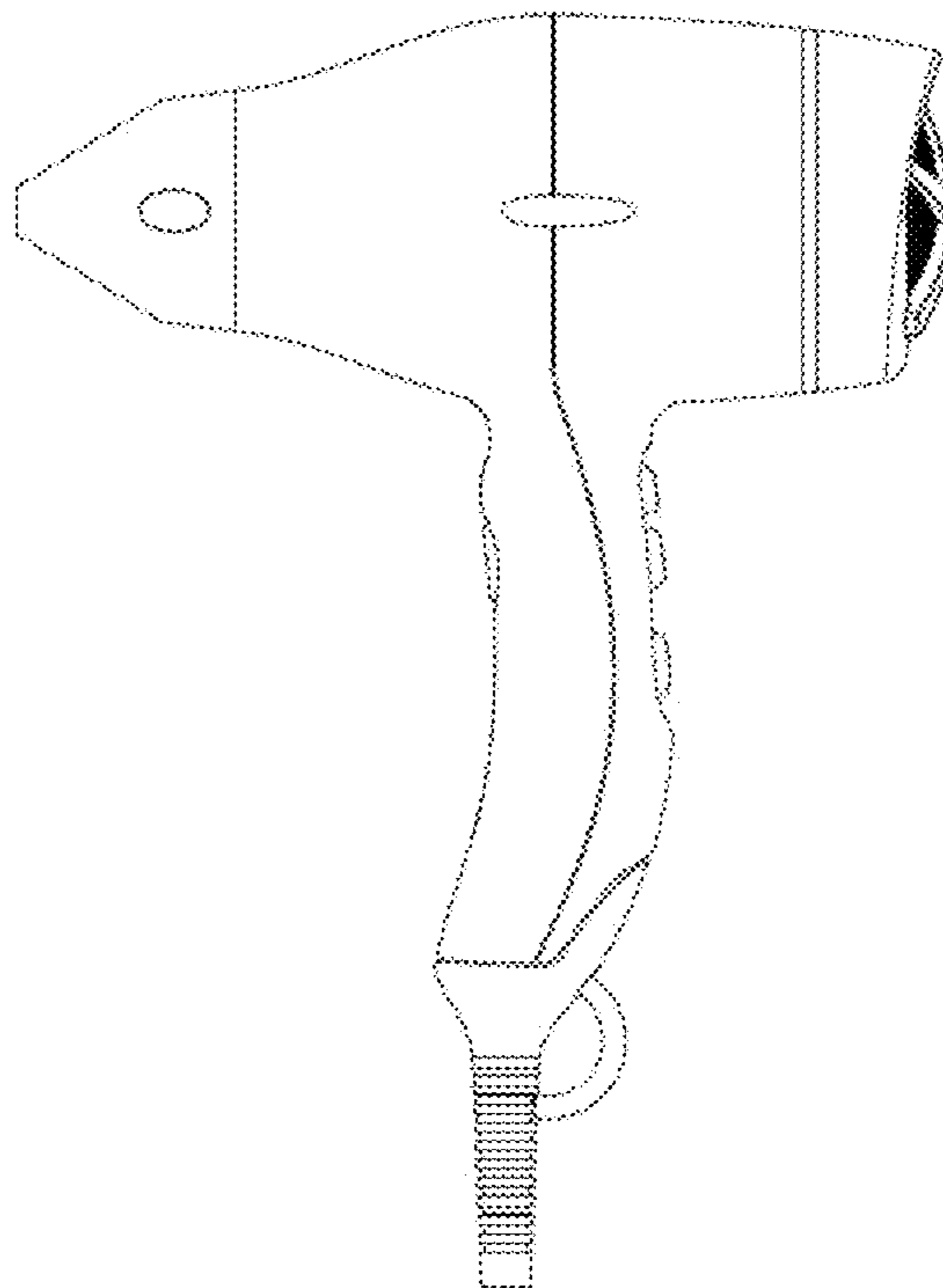

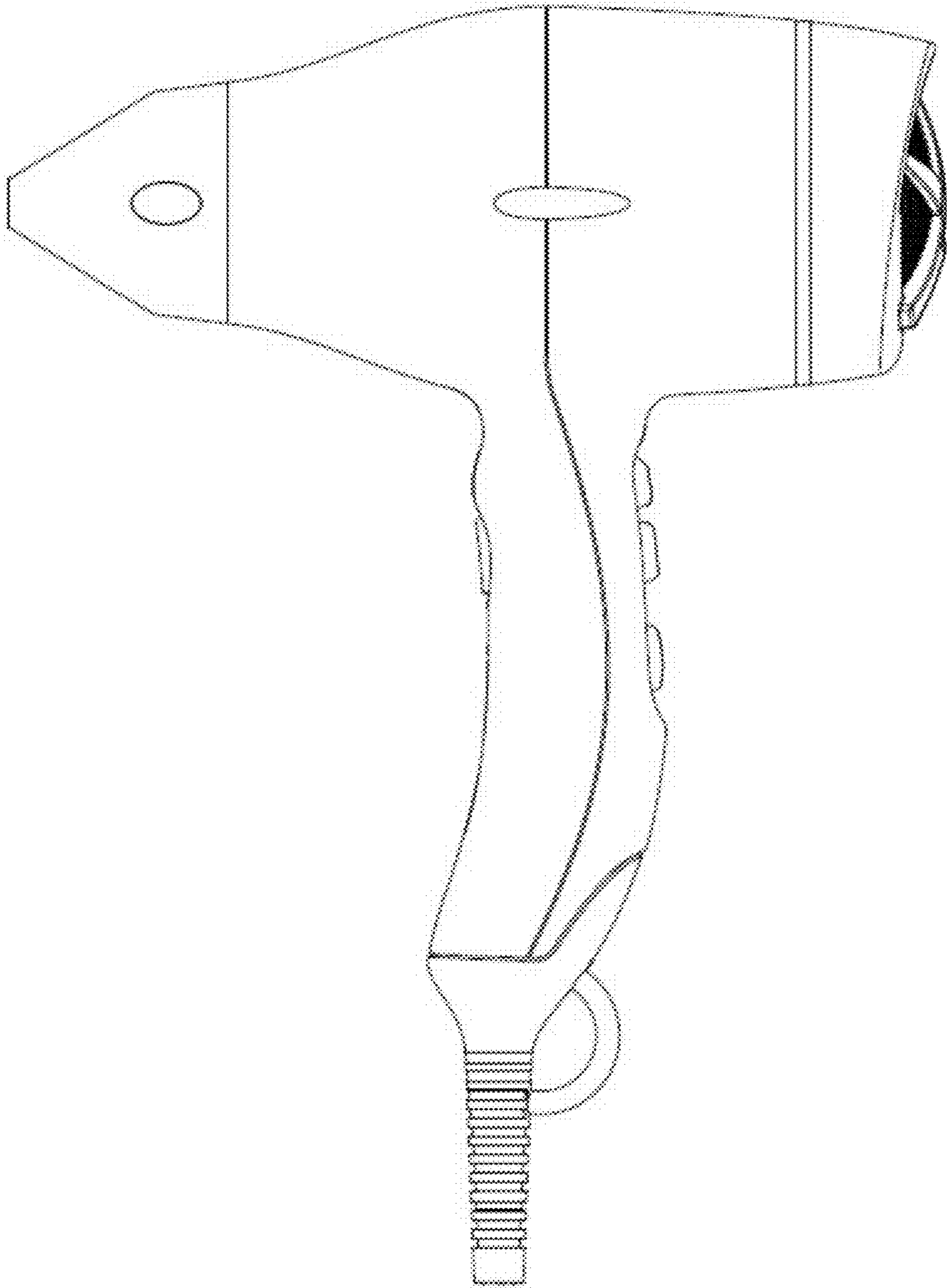

FIG. 1

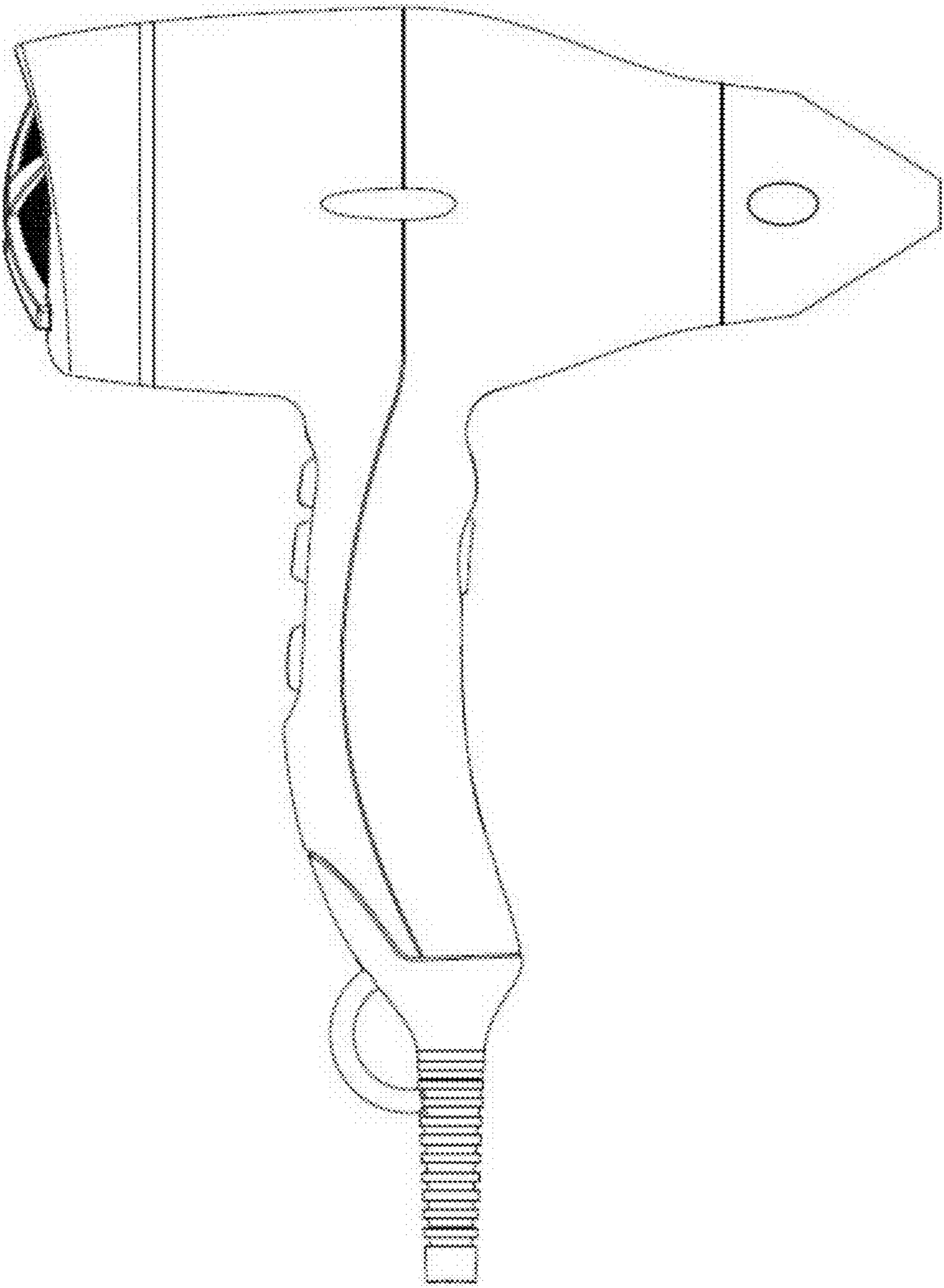

FIG. 2

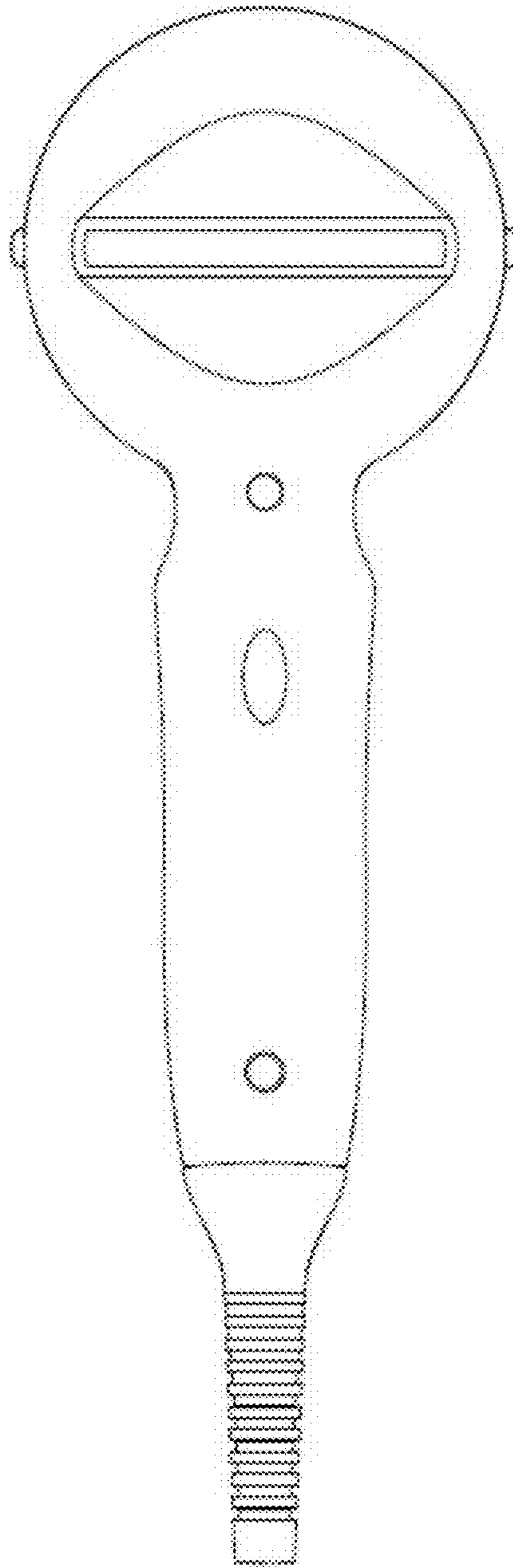

FIG. 3

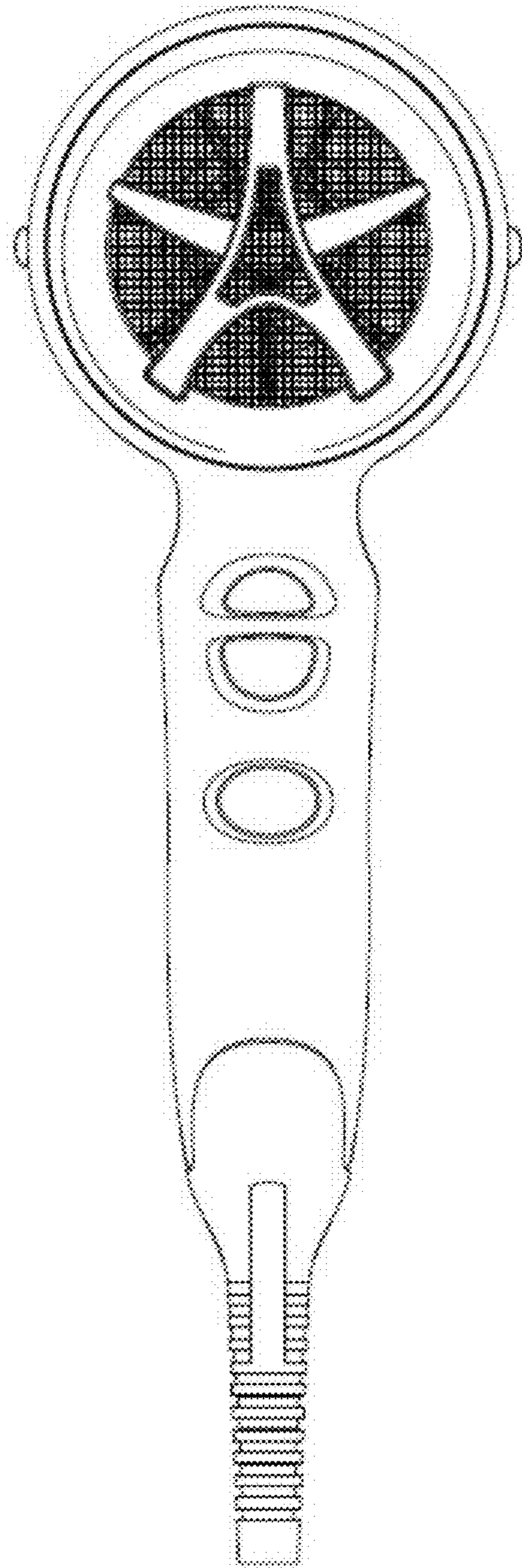

FIG. 4

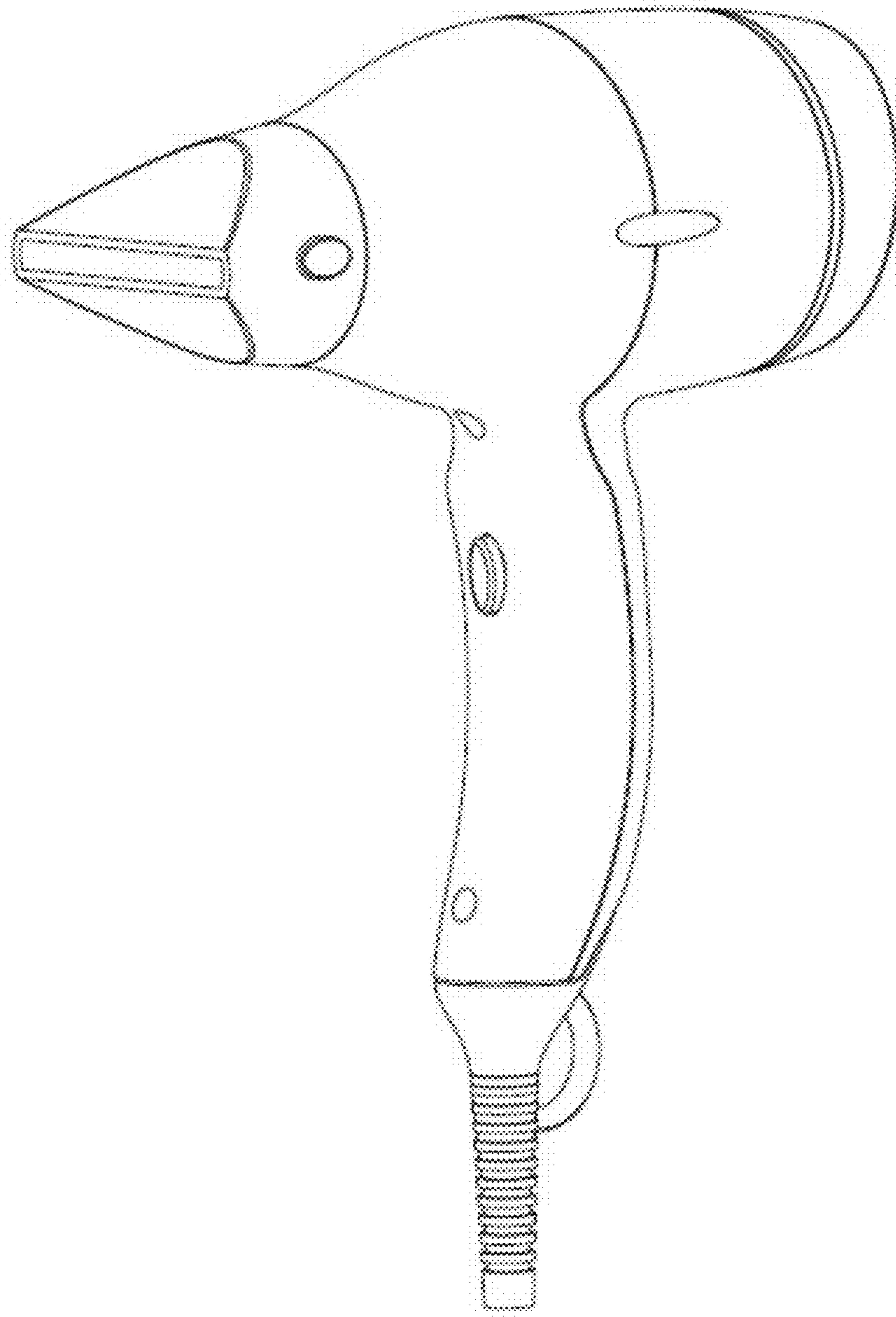

FIG. 5

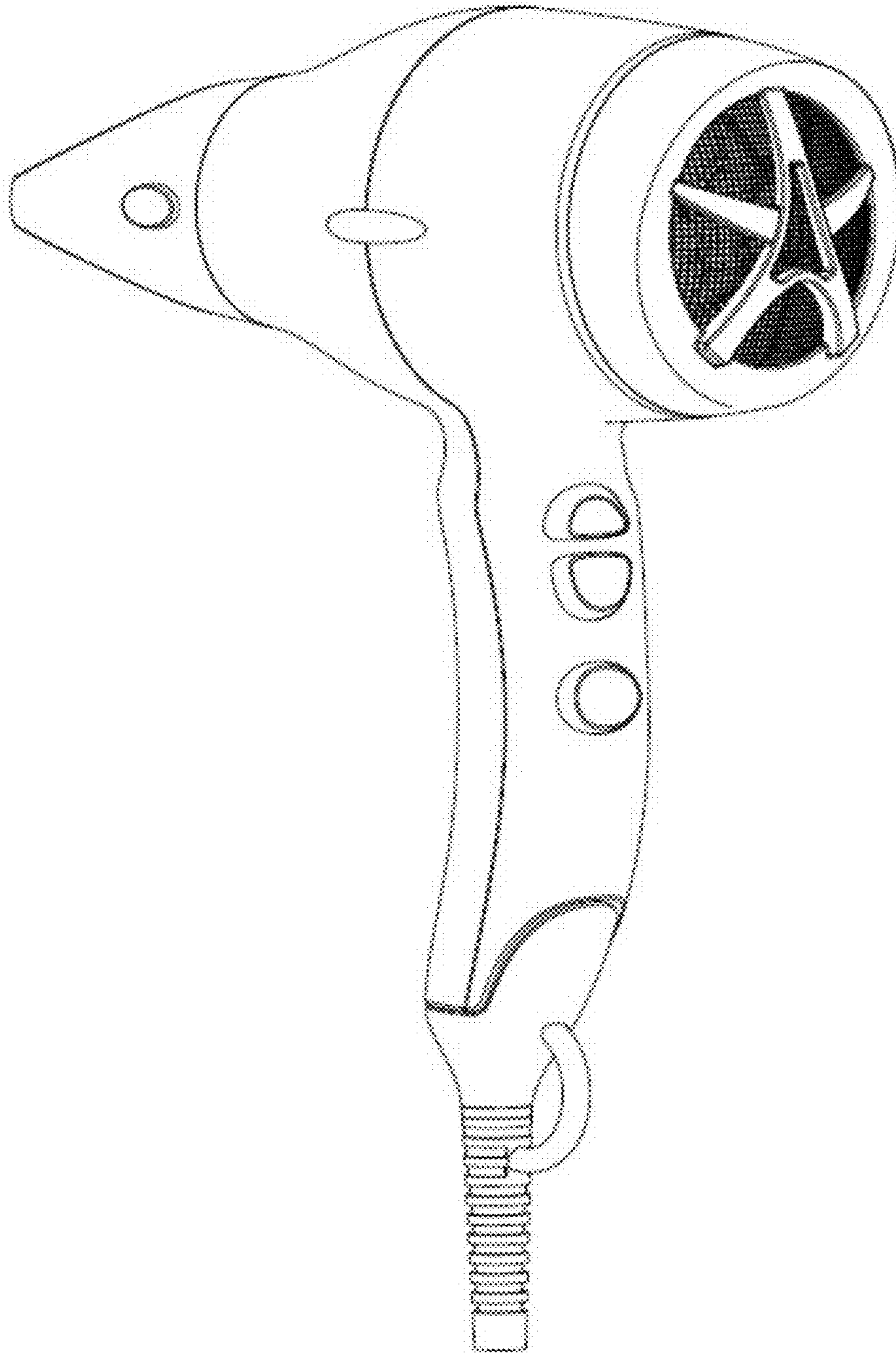

FIG. 6