



US00D787705S

(12) **United States Design Patent** (10) **Patent No.:** **US D787,705 S**  
**Grano** (45) **Date of Patent:** **\*\* May 23, 2017**

- (54) **SHADE STRUCTURE**
- (71) Applicant: **THE KITCHEN COMMUNITY, INC.**, Boulder, CO (US)
- (72) Inventor: **Jordan Grano**, Boulder, CO (US)
- (73) Assignee: **The Kitchen Community, Inc.**, Boulder, CO (US)
- (\*\*) Term: **15 Years**
- (21) Appl. No.: **29/547,452**
- (22) Filed: **Dec. 3, 2015**
- (51) **LOC (10) Cl.** ..... **25-03**
- (52) **U.S. Cl.**  
USPC ..... **D25/23**
- (58) **Field of Classification Search**  
USPC ..... D21/509, 511, 544, 837, 838, 840;  
D25/1, 3, 4, 12, 15, 17, 21, 22, 23, 24,  
D25/25, 26, 29, 30, 34, 56, 57, 58, 61,  
D25/199  
CPC ..... H02S 20/23; E04H 15/46; E04H 15/58;  
E04F 10/06; A45B 2023/0093  
See application file for complete search history.

(56) **References Cited**

**U.S. PATENT DOCUMENTS**

- D523,969 S \* 6/2006 Abruzese ..... D25/56
- D530,827 S \* 10/2006 Haymann ..... D25/56
- D530,829 S \* 10/2006 Haymann ..... D25/56
- D562,426 S \* 2/2008 Goldsmith ..... D21/837
- D625,025 S \* 10/2010 Colmore-Williams ..... D21/837
- D645,929 S \* 9/2011 Warren ..... D21/837
- D698,941 S \* 2/2014 Cropley ..... D25/56
- D727,452 S \* 4/2015 Yang ..... D21/837
- D739,955 S \* 9/2015 Indio da Costa ..... D25/1

- D746,395 S \* 12/2015 Rademacher ..... D21/835
- D747,816 S \* 1/2016 Indio da Costa ..... D25/1
- D748,820 S \* 2/2016 Indio da Costa ..... D25/56
- D754,874 S \* 4/2016 Boga ..... D25/22
- D755,987 S \* 5/2016 Indio da Costa ..... D25/1
- 2016/0160523 A1\* 6/2016 Huang ..... E04H 15/52  
135/139
- 2016/0165822 A1\* 6/2016 Iwai ..... A01G 9/243  
47/60
- 2016/0348395 A1\* 12/2016 Jin ..... E04H 15/50
- 2016/0365826 A1\* 12/2016 DeBartolo, III ..... H02S 20/23

\* cited by examiner

*Primary Examiner* — Manpreet Matharu  
*Assistant Examiner* — Suzanne Tisdell  
(74) *Attorney, Agent, or Firm* — Holland & Hart LLP

(57) **CLAIM**

The ornamental design for a shade structure, as shown and described.

**DESCRIPTION**

FIG. 1 is a top perspective view of the shade structure, showing my new design;  
FIG. 2 is a front elevation view of the design illustrated in FIG. 1;  
FIG. 3 is a rear elevation view of the design illustrated in FIG. 1;  
FIG. 4 is a right side elevation view of the design illustrated in FIG. 1;  
FIG. 5 is a left side elevation view of the design illustrated in FIG. 1;  
FIG. 6 is a top plan view of the design illustrated in FIG. 1; and,  
FIG. 7 is a bottom plan view of the design illustrated in FIG. 1.

**1 Claim, 7 Drawing Sheets**

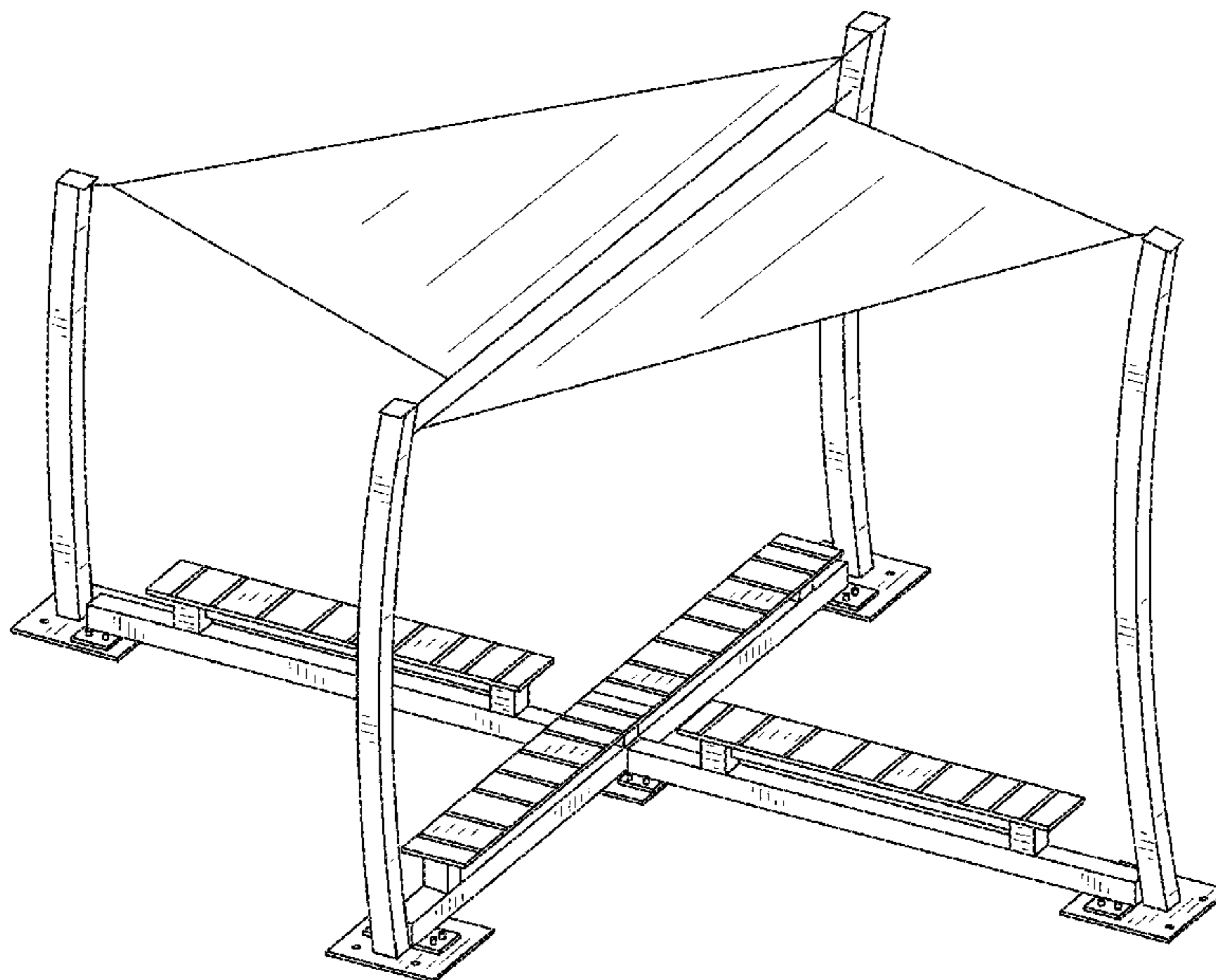

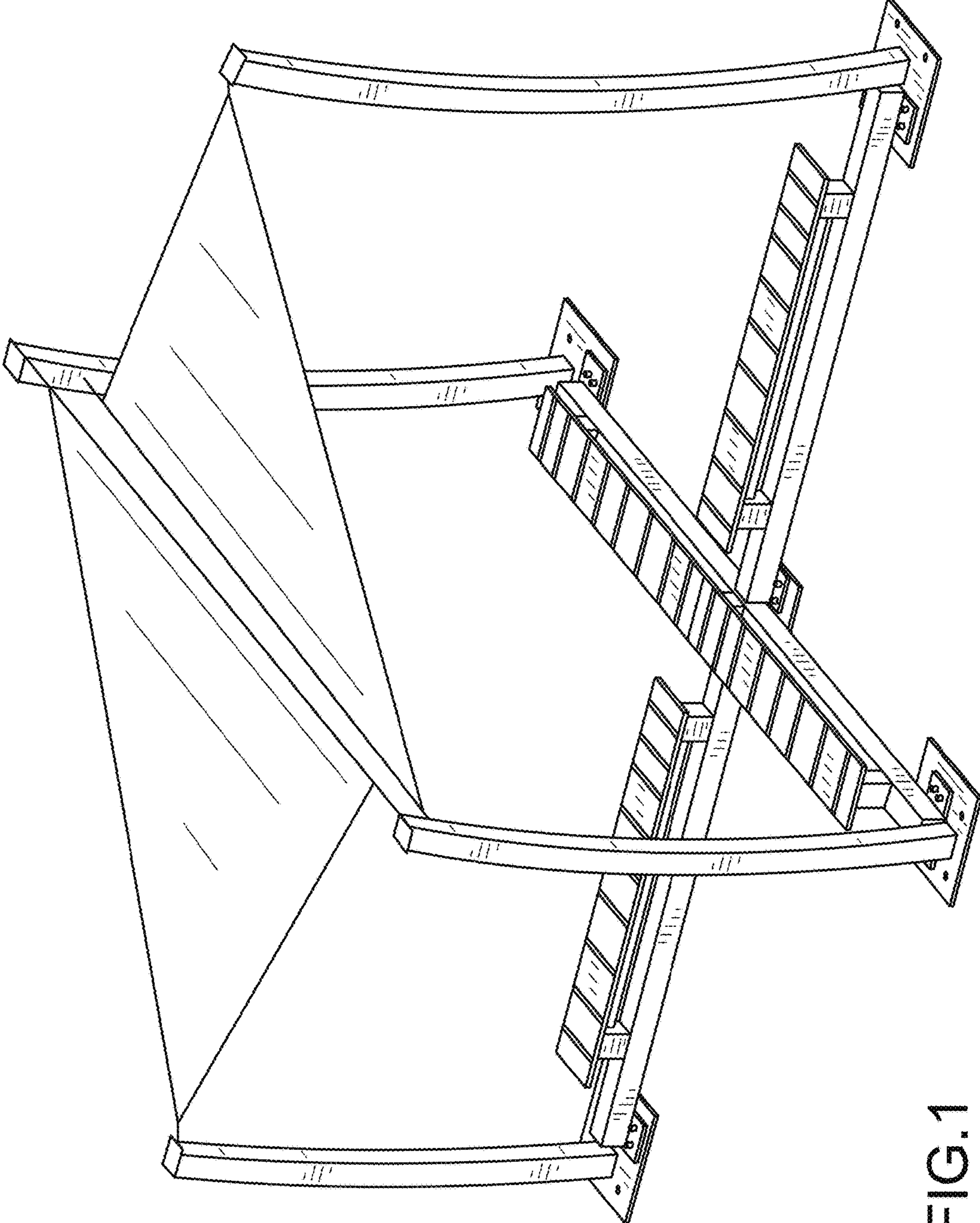

FIG.1

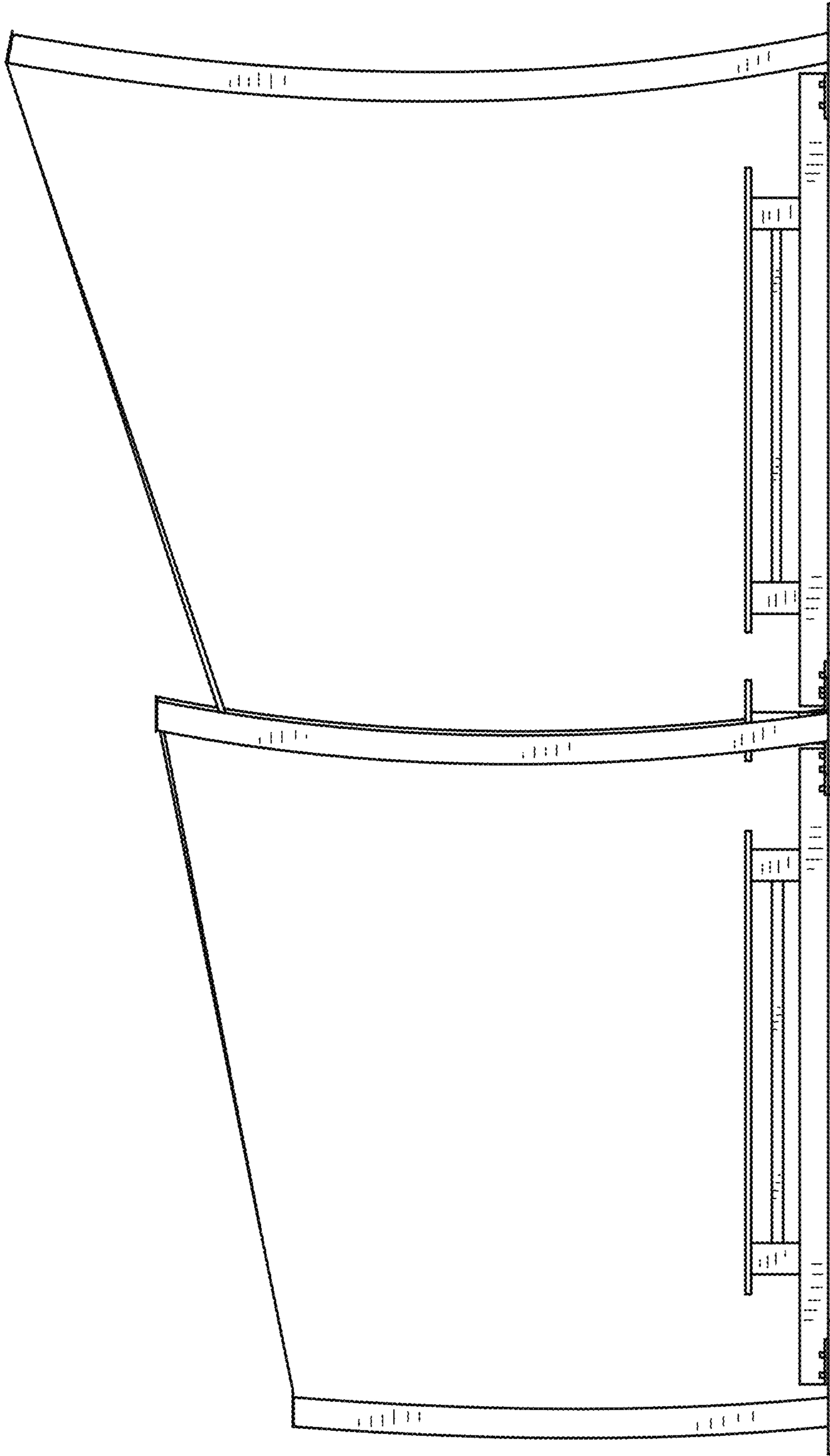

FIG.2

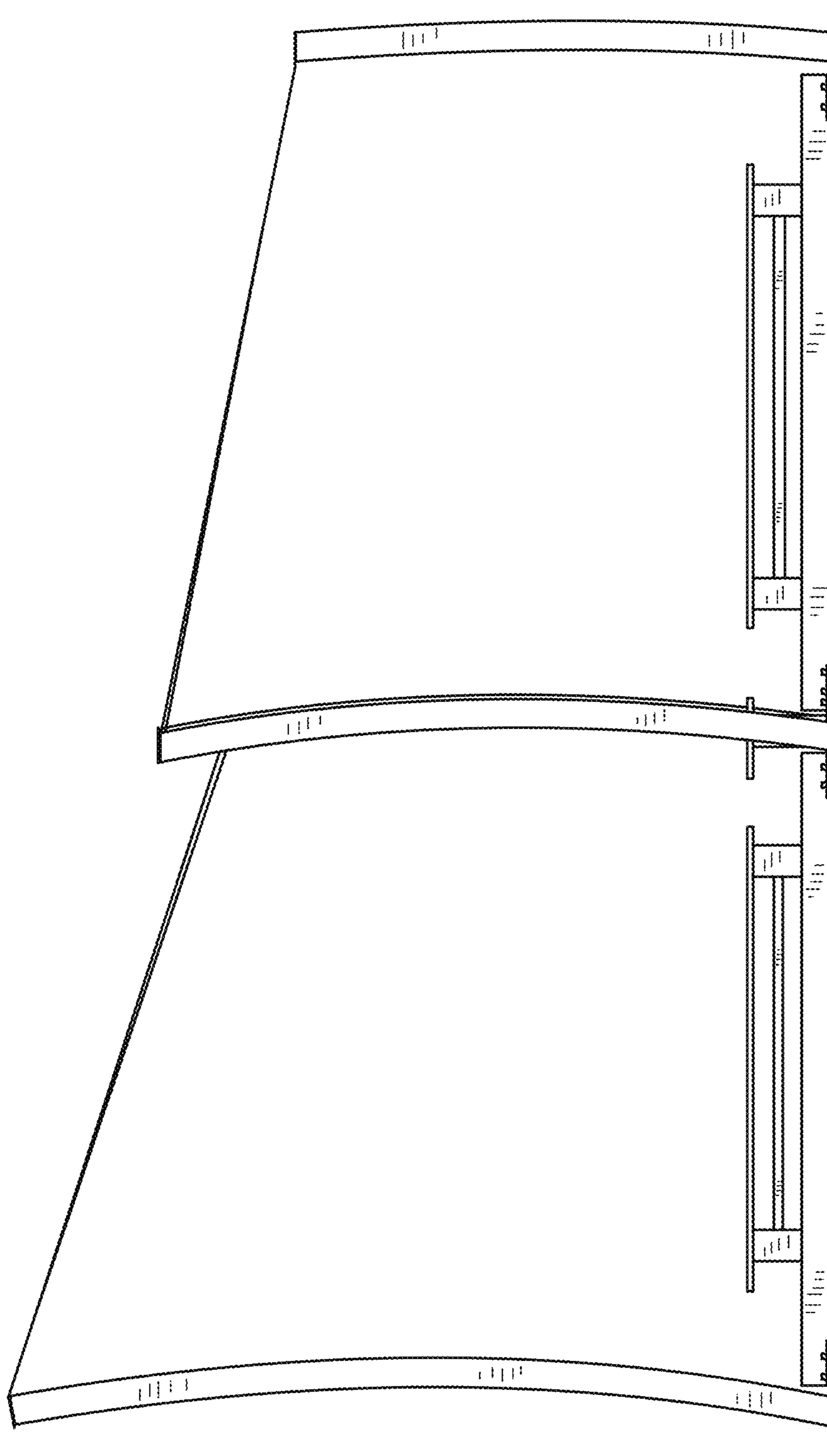

FIG.3

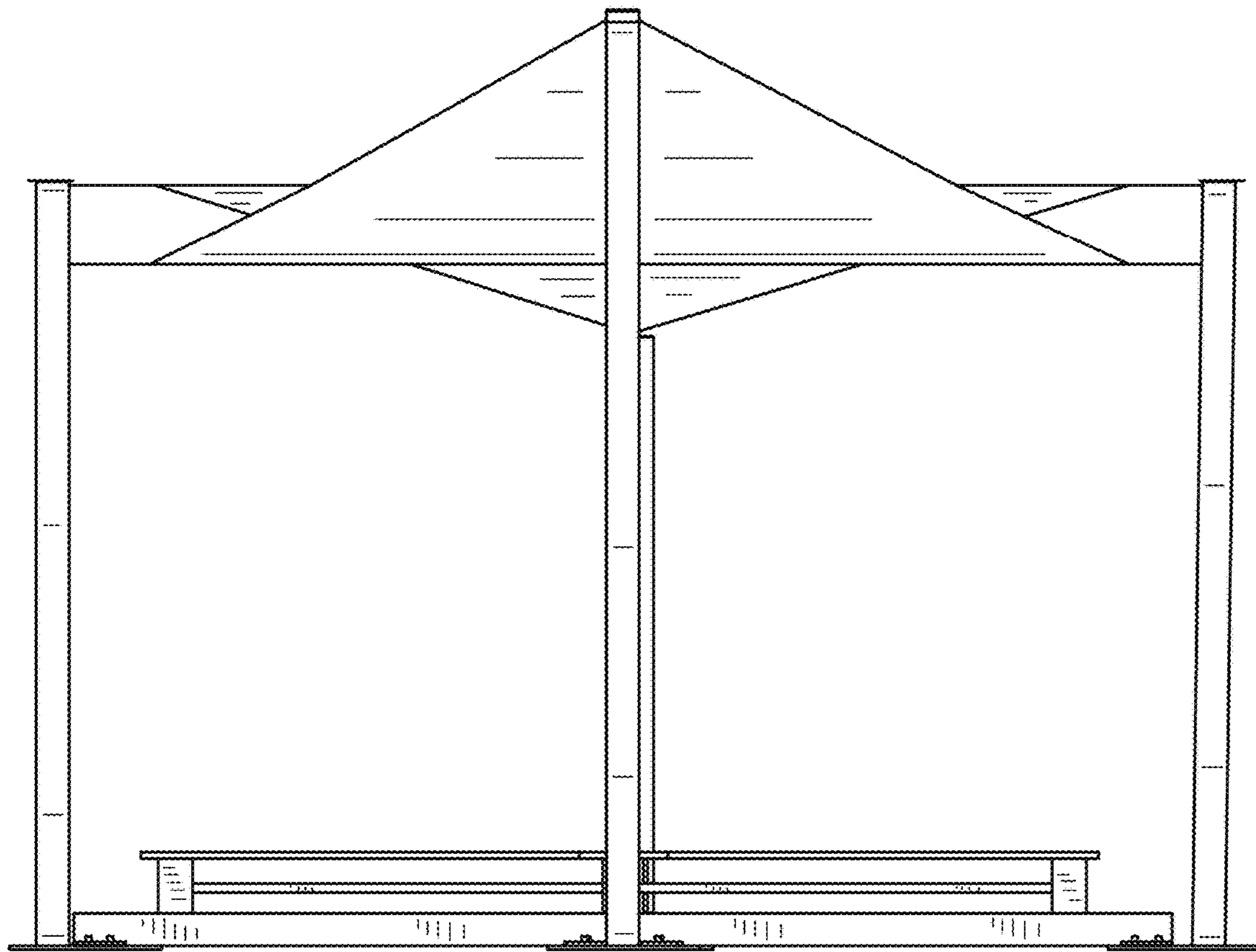

FIG.4

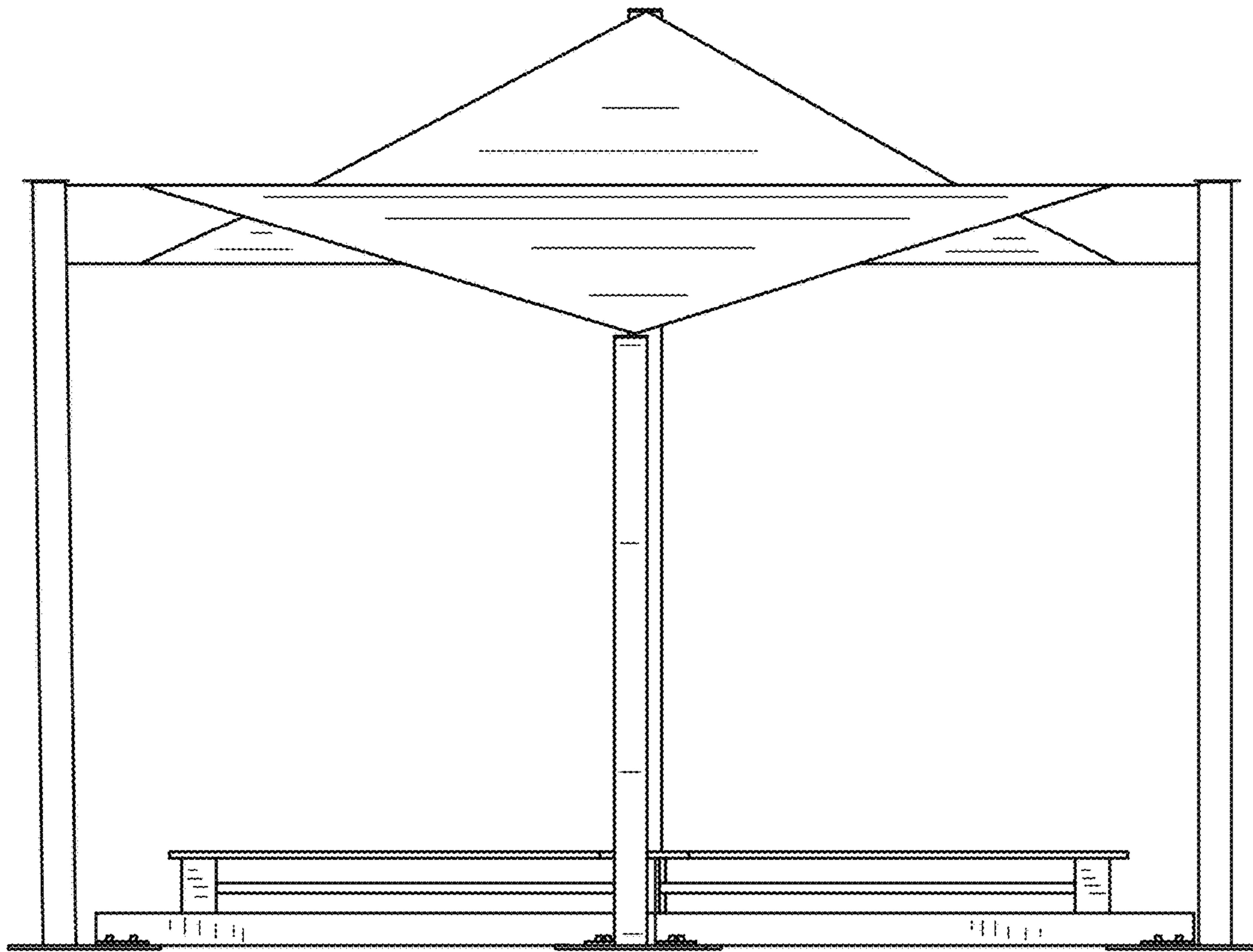

FIG.5

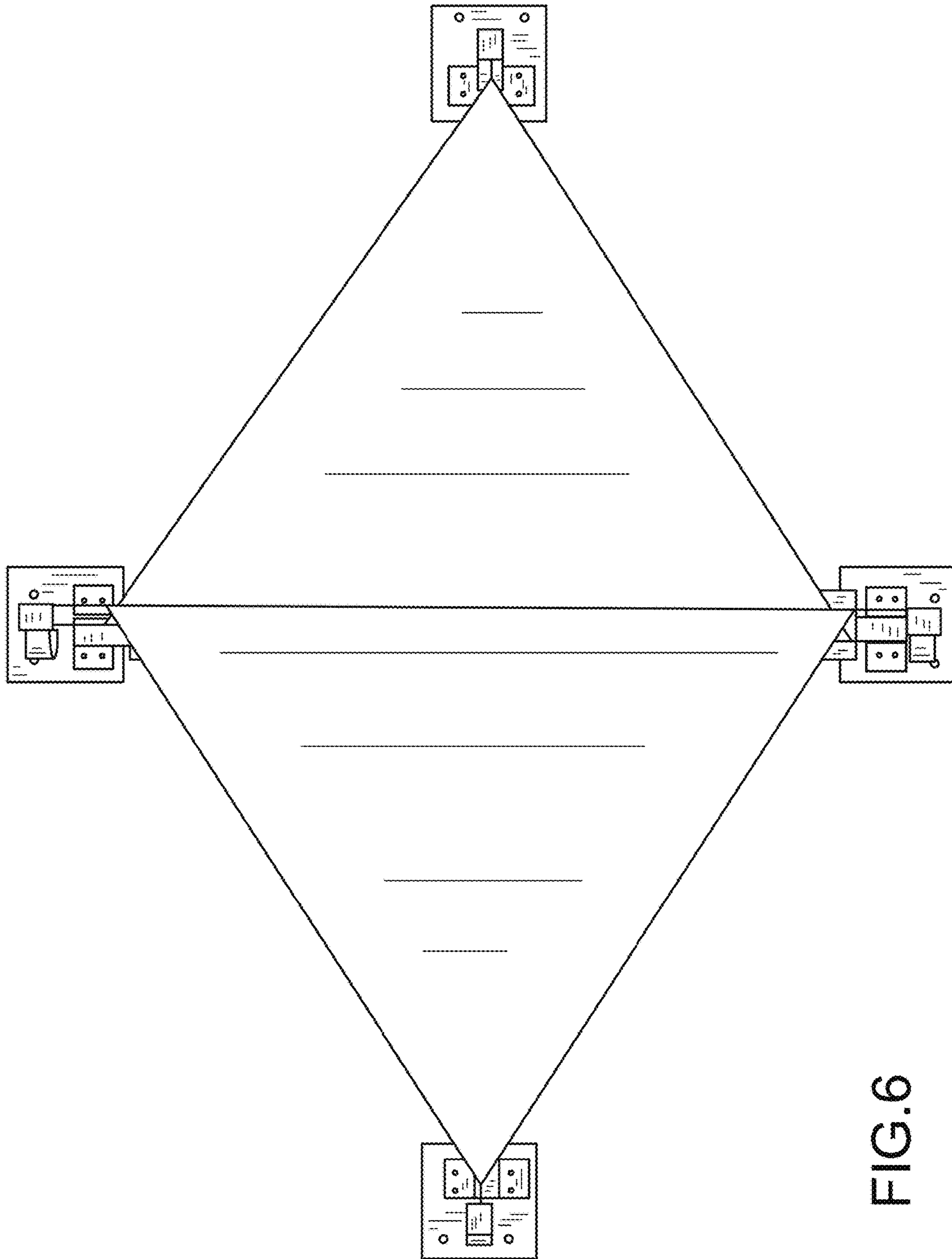

FIG.6

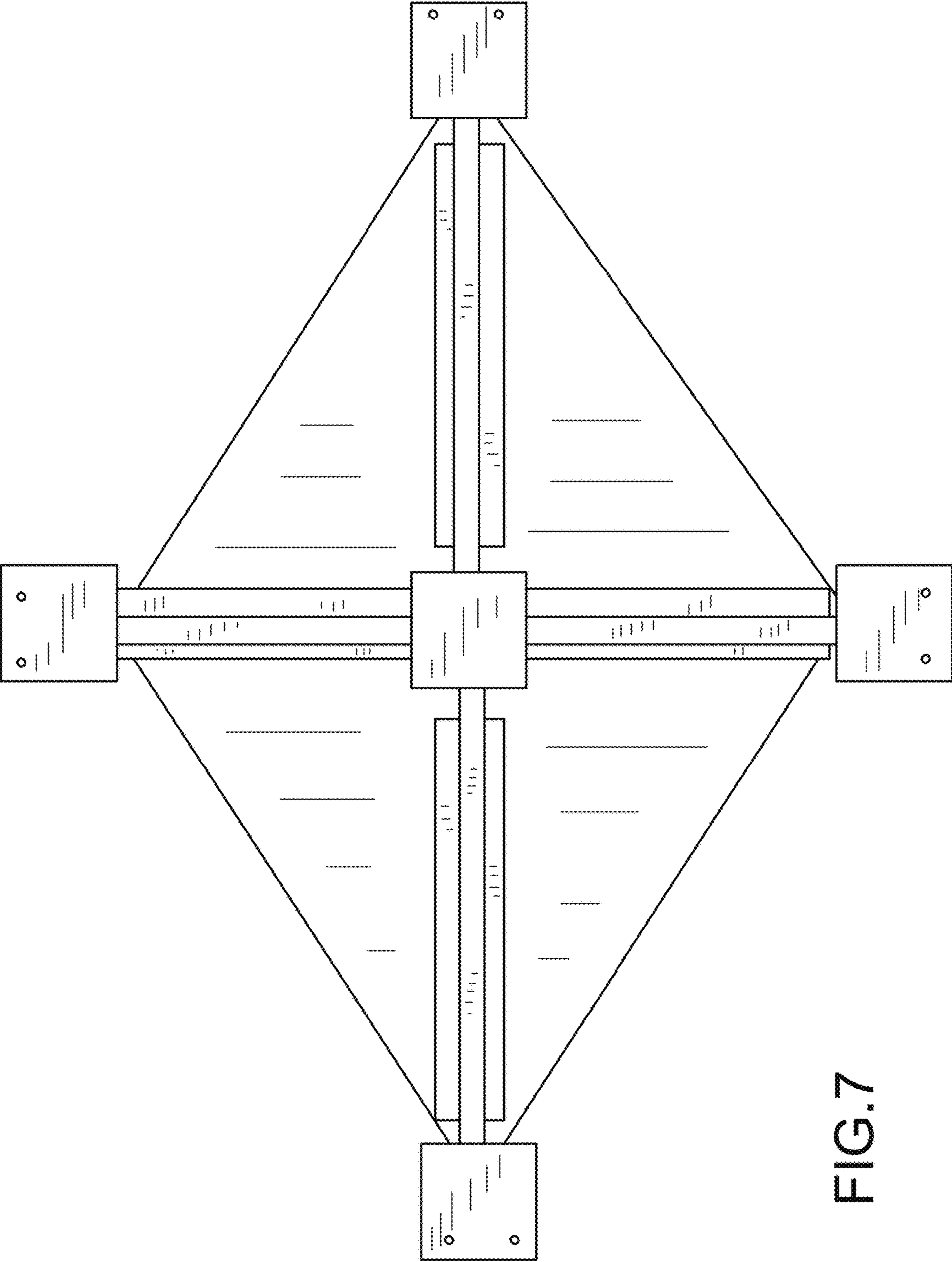

FIG.7