



US00D787693S

(12) **United States Design Patent**
Matsushita

(10) **Patent No.:** **US D787,693 S**

(45) **Date of Patent:** **** May 23, 2017**

(54) **COSMETIC SKIN TREATMENT APPARATUS**

(71) Applicant: **MTG Co., Ltd.**, Nagoya-shi, Aichi-ken (JP)

(72) Inventor: **Tsuyoshi Matsushita**, Nagoya (JP)

(73) Assignee: **MTG CO., LTD.**, Nagoya-shi (JP)

(**) Term: **15 Years**

(21) Appl. No.: **29/546,262**

(22) Filed: **Nov. 20, 2015**

(51) **LOC (10) Cl.** **28-03**

(52) **U.S. Cl.**
USPC **D24/200**

(58) **Field of Classification Search**
USPC D24/200, 211-215, 188
CPC A61N 5/0616; A61B 17/52; A61H 7/00;
A61H 7/001; A61H 7/003; A61H 7/005;
A61H 23/00; A61H 2201/0153; A61H
2201/1253; A61H 2205/00-2205/022;
A61H 2205/024-2205/125; A61H
15/0085; A61H 15/0092
See application file for complete search history.

(56) **References Cited**

U.S. PATENT DOCUMENTS

D338,964 S * 8/1993 Tarjoto D24/200
D671,226 S * 11/2012 Aulwes D24/215

D692,570 S * 10/2013 Luzon D24/215
D726,926 S * 4/2015 Matsushita D24/200
D758,600 S * 6/2016 Matsushita D24/200
D772,422 S * 11/2016 Sedic D24/215
2011/0098613 A1* 4/2011 Thomas A61H 7/005
601/46
2015/0150599 A1* 6/2015 Matsushita A61B 17/52
604/20

* cited by examiner

Primary Examiner — Wan Laymon

(74) *Attorney, Agent, or Firm* — Westerman, Hattori,
Daniels & Adrian, LLP

(57) **CLAIM**

The ornamental design for a cosmetic skin treatment apparatus, as shown and described.

DESCRIPTION

FIG. 1 is a top, front and right side perspective view of a cosmetic skin treatment apparatus showing my new design; FIG. 2 is a bottom, rear and right side perspective view thereof; FIG. 3 is a front elevational view thereof, the rear elevational view being a mirror image thereof; FIG. 4 is a right side elevational view thereof; FIG. 5 is a left side elevational view thereof; FIG. 6 is a top plan view thereof; and, FIG. 7 is a bottom plan view thereof.

1 Claim, 7 Drawing Sheets

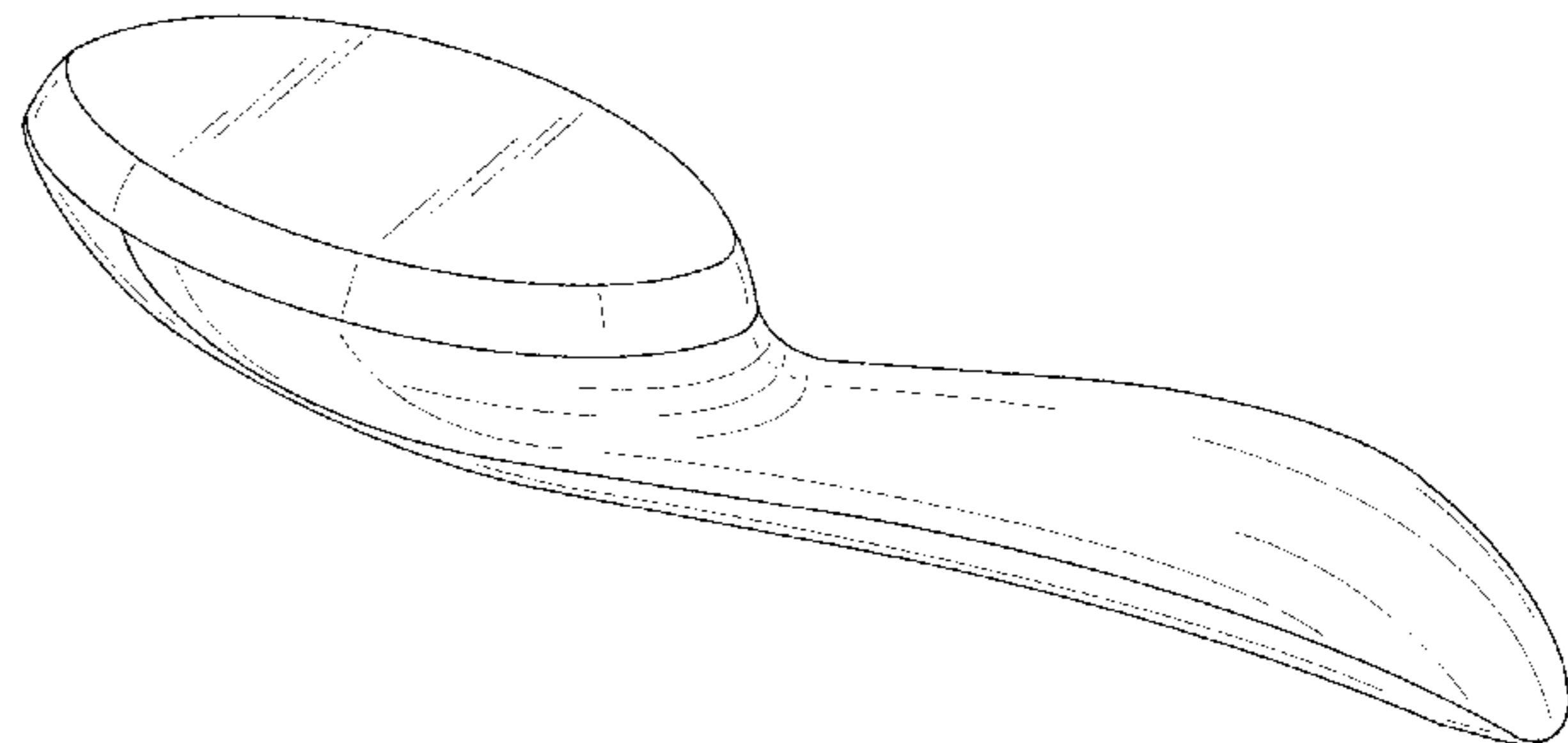
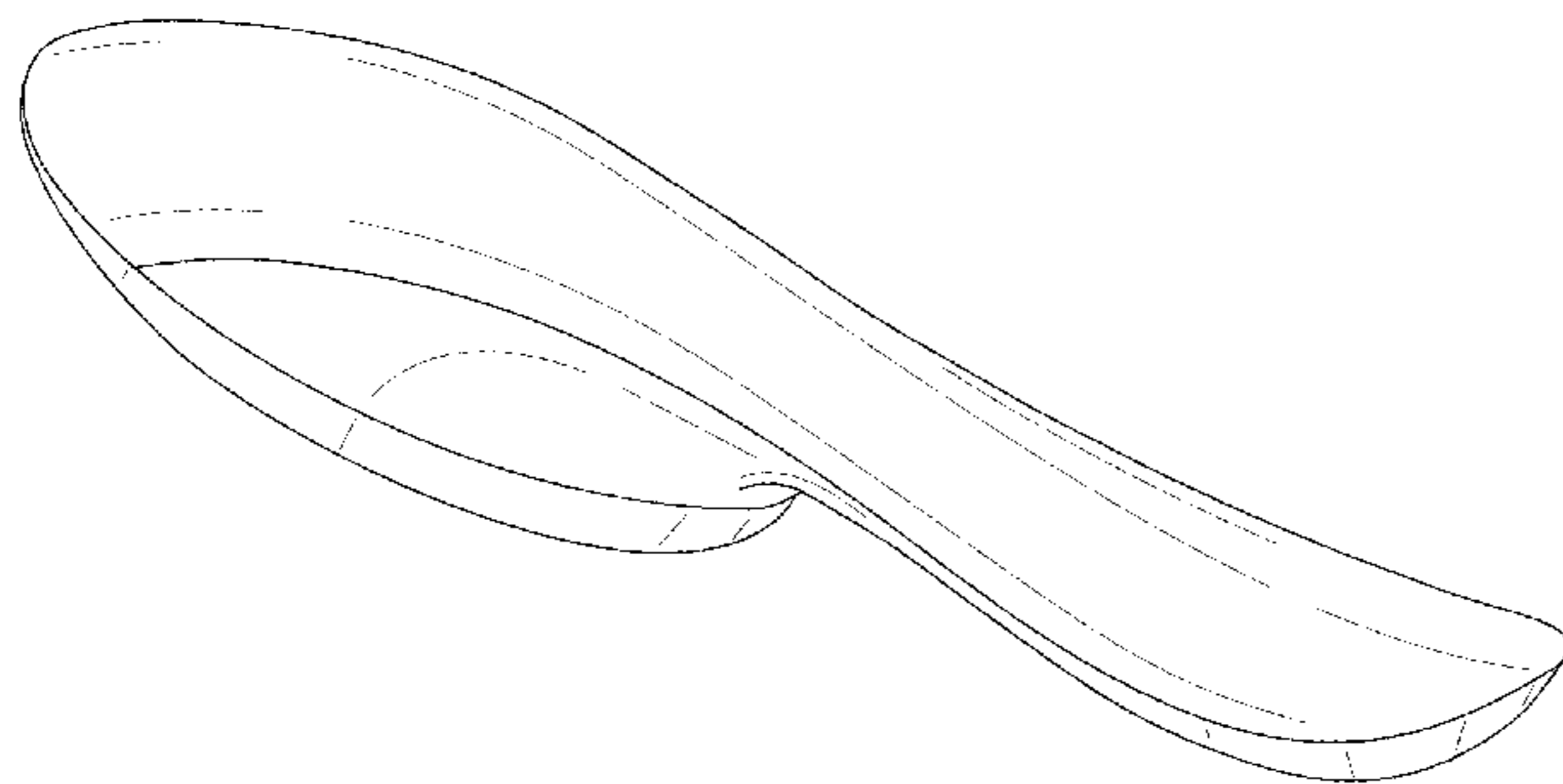



FIG. 1

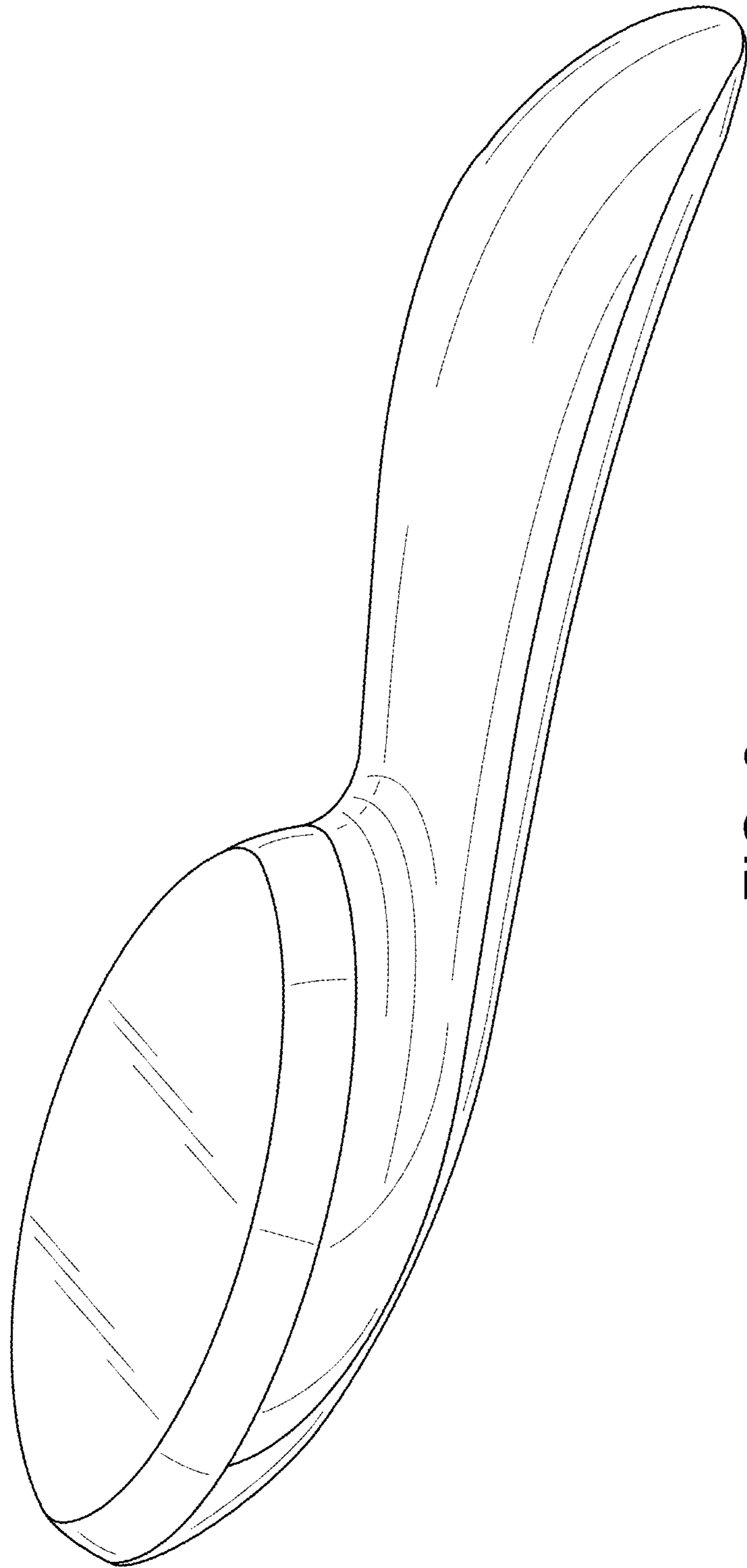

FIG. 2

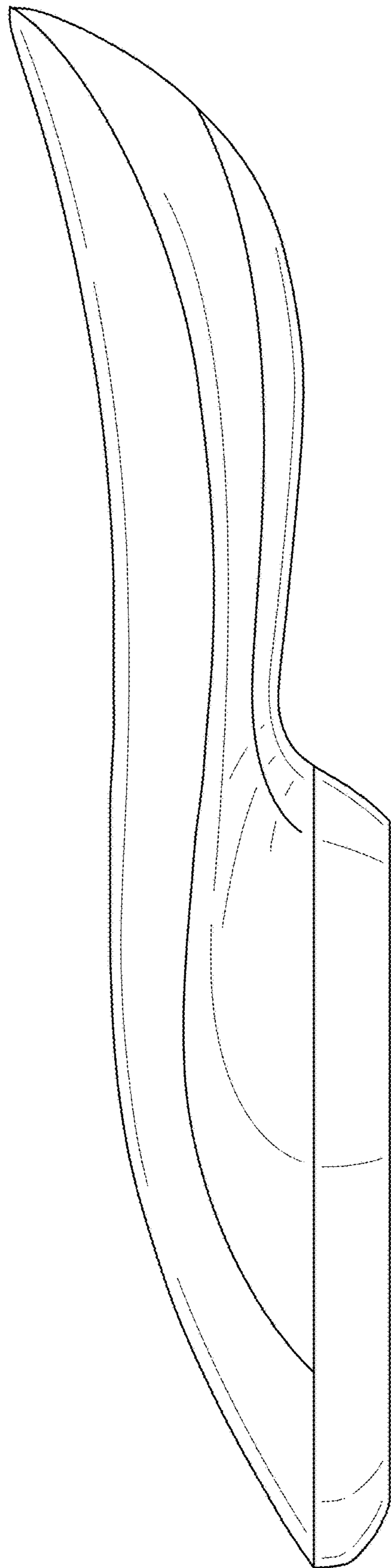

FIG. 3

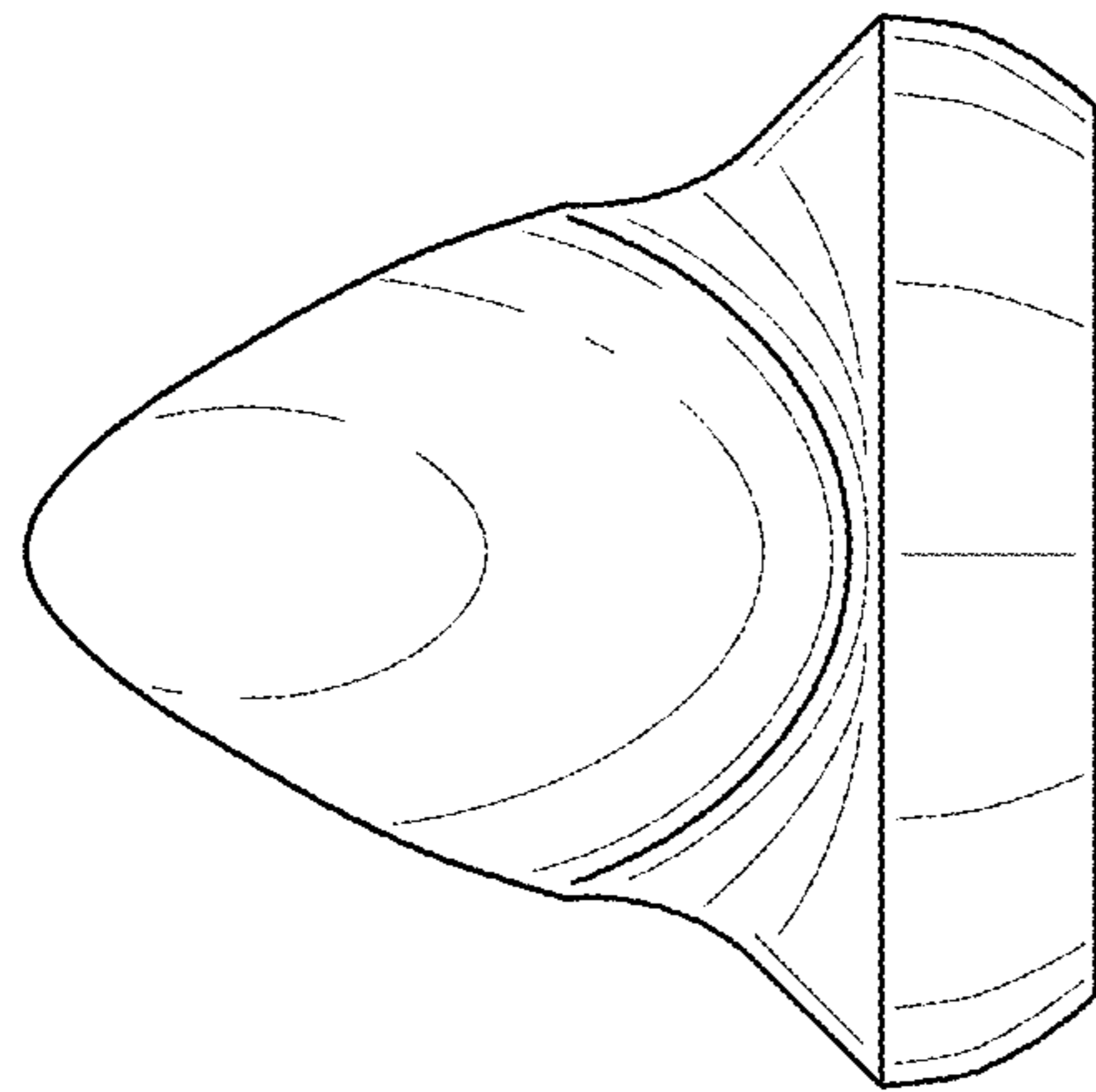

FIG. 4

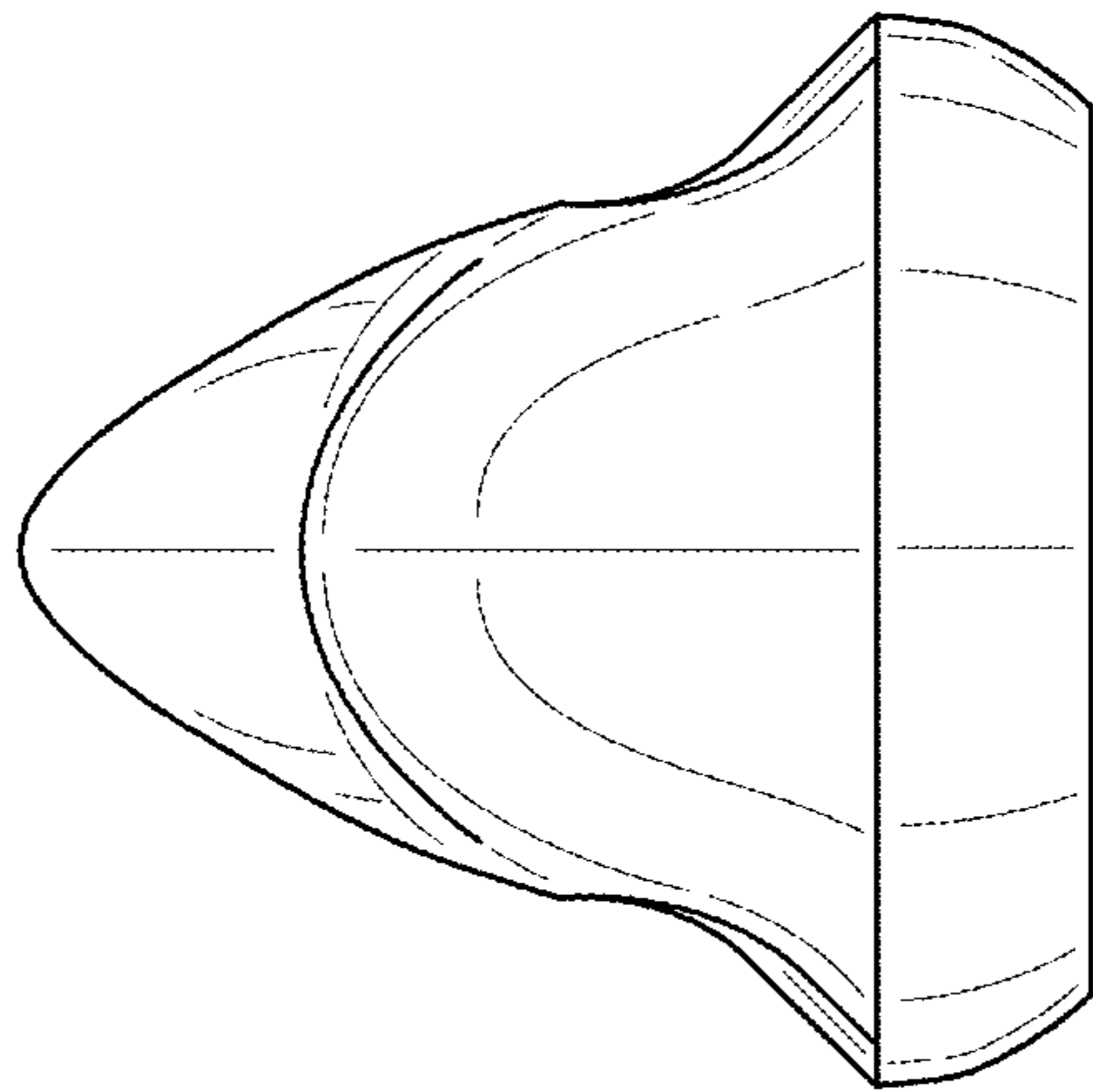

FIG. 5

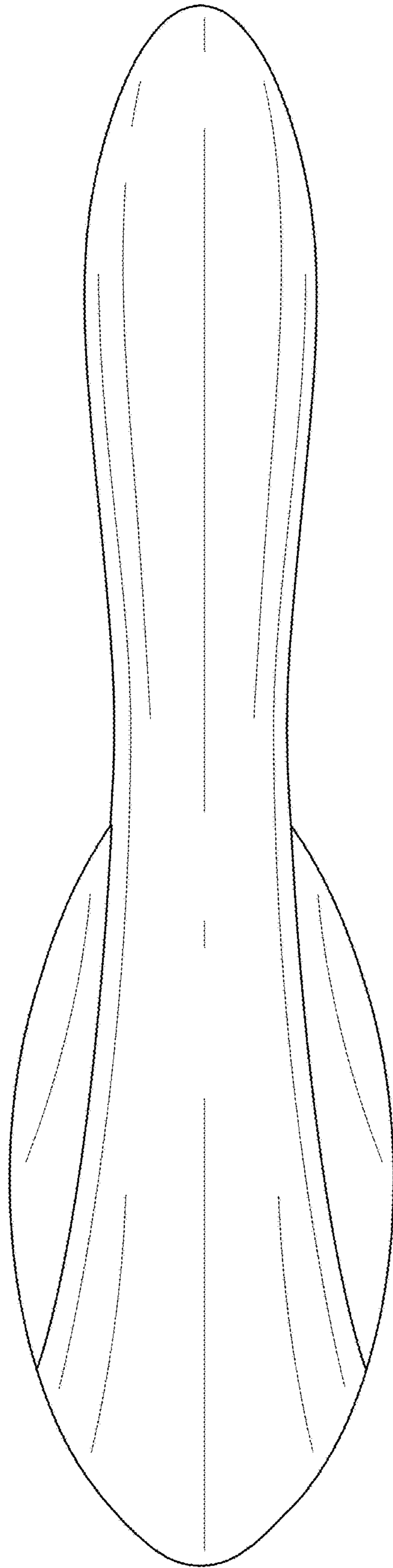

FIG. 6

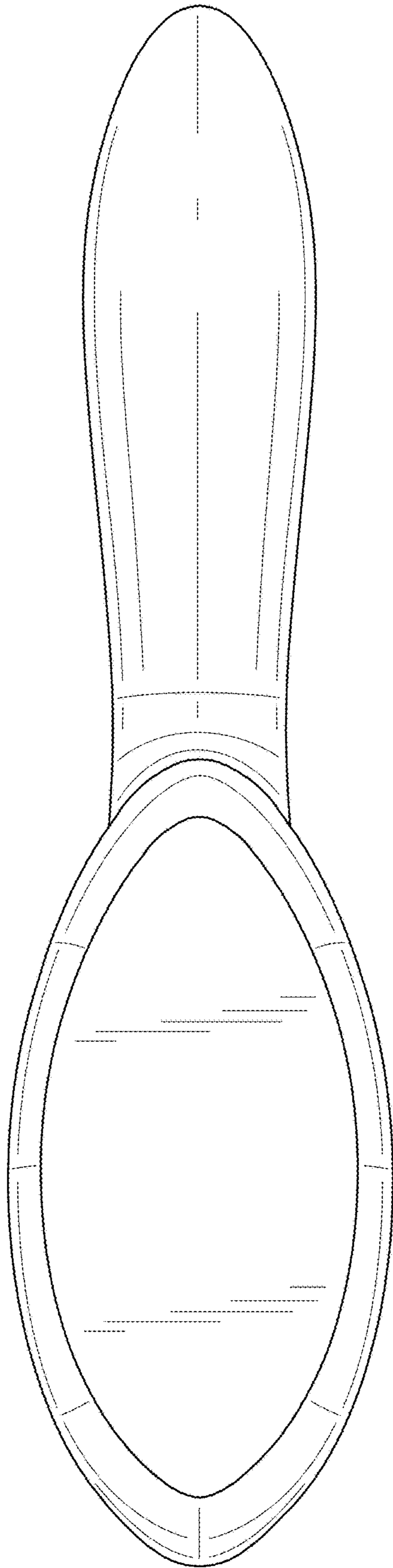

FIG. 7