



US00D787666S

(12) **United States Design Patent**
Ohashi

(10) **Patent No.:** **US D787,666 S**

(45) **Date of Patent:** **** May 23, 2017**

(54) **MAIN BODY FOR INTRADERMAL INJECTION DEVICE**

(71) Applicant: **Terumo Kabushiki Kaisha**,
Shibuya-ku, Tokyo (JP)

(72) Inventor: **Hirotaka Ohashi**, Tokyo (JP)

(73) Assignee: **Terumo Kabushiki Kaisha**,
Shibuya-ku, Tokyo (JP)

(**) Term: **15 Years**

(21) Appl. No.: **29/532,690**

(22) Filed: **Jul. 9, 2015**

(30) **Foreign Application Priority Data**

Jan. 9, 2015 (JP) 2015-000300

(51) **LOC (10) Cl.** **24-02**

(52) **U.S. Cl.**
USPC **D24/130**

(58) **Field of Classification Search**

USPC D24/127–131, 112–114, 133, 186;
606/181, 185; 604/264, 523–528, 272,
604/187, 158, 164.01–164.11, 181, 184,
604/227; 600/101, 139, 143;
128/200.24, 207.14, 207.15

CPC A61M 5/178; A61M 3/00; A61M 5/20;
A61M 5/31; A61M 5/3146; A61M
5/3129; A61M 5/3148; A61M 5/315

See application file for complete search history.

(56) **References Cited**

U.S. PATENT DOCUMENTS

D474,838 S * 5/2003 Mahurkar D24/112
D616,985 S * 6/2010 Ade D24/130

D617,453 S * 6/2010 Shaw D24/130
D617,454 S * 6/2010 Shaw D24/130
D640,787 S * 6/2011 Chia D24/130
D650,903 S * 12/2011 Kosinski D24/130
D674,085 S * 1/2013 Fujioka D24/113
D690,007 S * 9/2013 Ingram D24/130
8,636,703 B2 * 1/2014 Foshee A61J 1/2096
128/919
D713,522 S * 9/2014 Woehr D24/112
D714,935 S * 10/2014 Nishioka D24/130
D715,428 S * 10/2014 Baid D24/130
D726,305 S * 4/2015 Furukawa D24/114
D732,664 S * 6/2015 Woehr D24/130
D748,777 S * 2/2016 Uenishi D24/130

* cited by examiner

Primary Examiner — David Muller

(74) *Attorney, Agent, or Firm* — Banner & Witcoff, Ltd.

(57) **CLAIM**

The ornamental design for the main body for intradermal injection device, as shown and described.

DESCRIPTION

FIG. 1 is a perspective view of front, bottom and right side of the main body for intradermal injection device showing my new design;

FIG. 2 is a front view thereof;

FIG. 3 is a rear view thereof;

FIG. 4 is a left side view thereof;

FIG. 5 is a right side view thereof;

FIG. 6 is a top view thereof;

FIG. 7 is a bottom view thereof; and,

FIG. 8 is an explanatory view of usage thereof.

The broken lines shown are included for the purpose of illustrating the unclaimed portions of the main body for intradermal injection device and form no part of the claimed design.

1 Claim, 5 Drawing Sheets

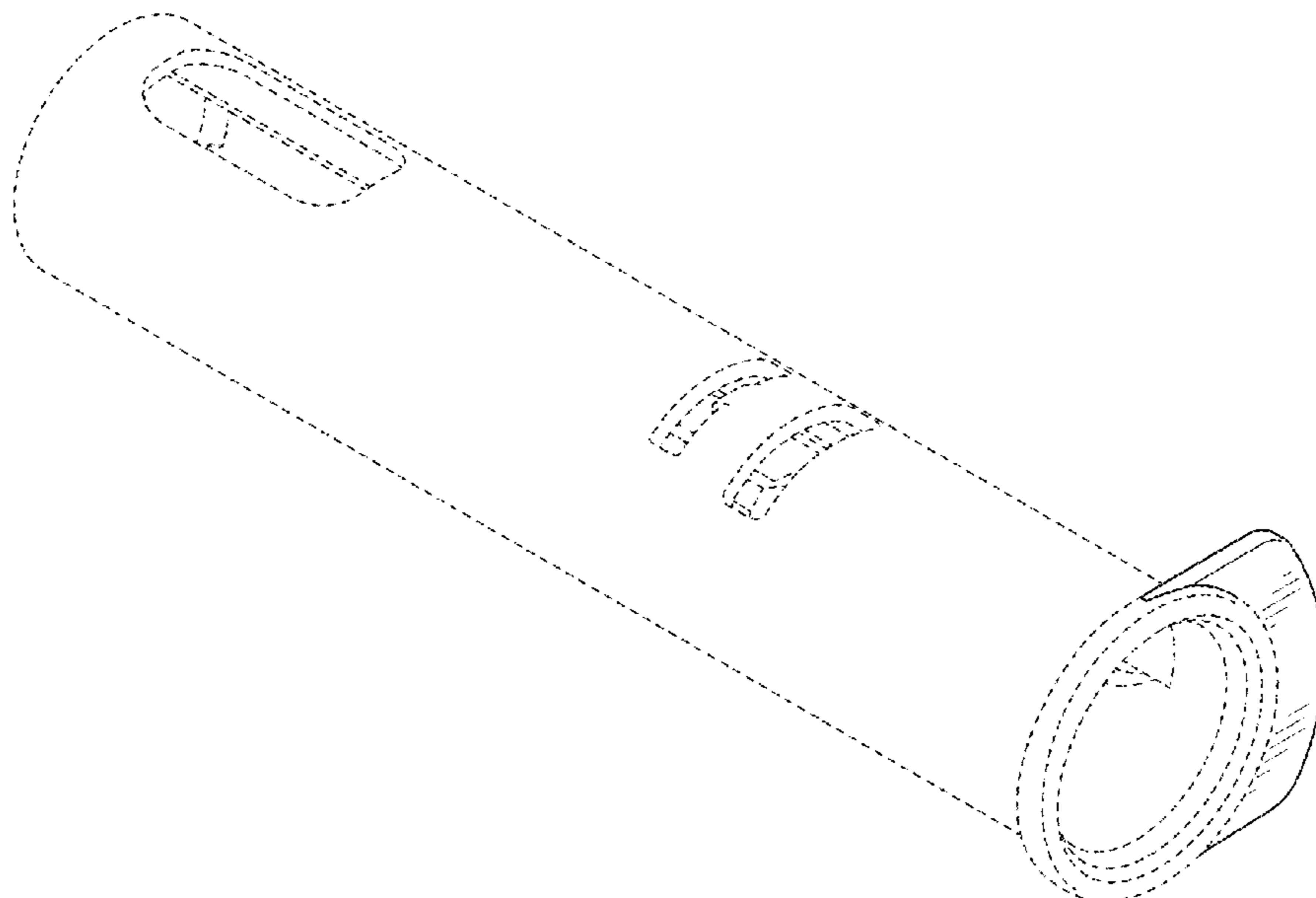

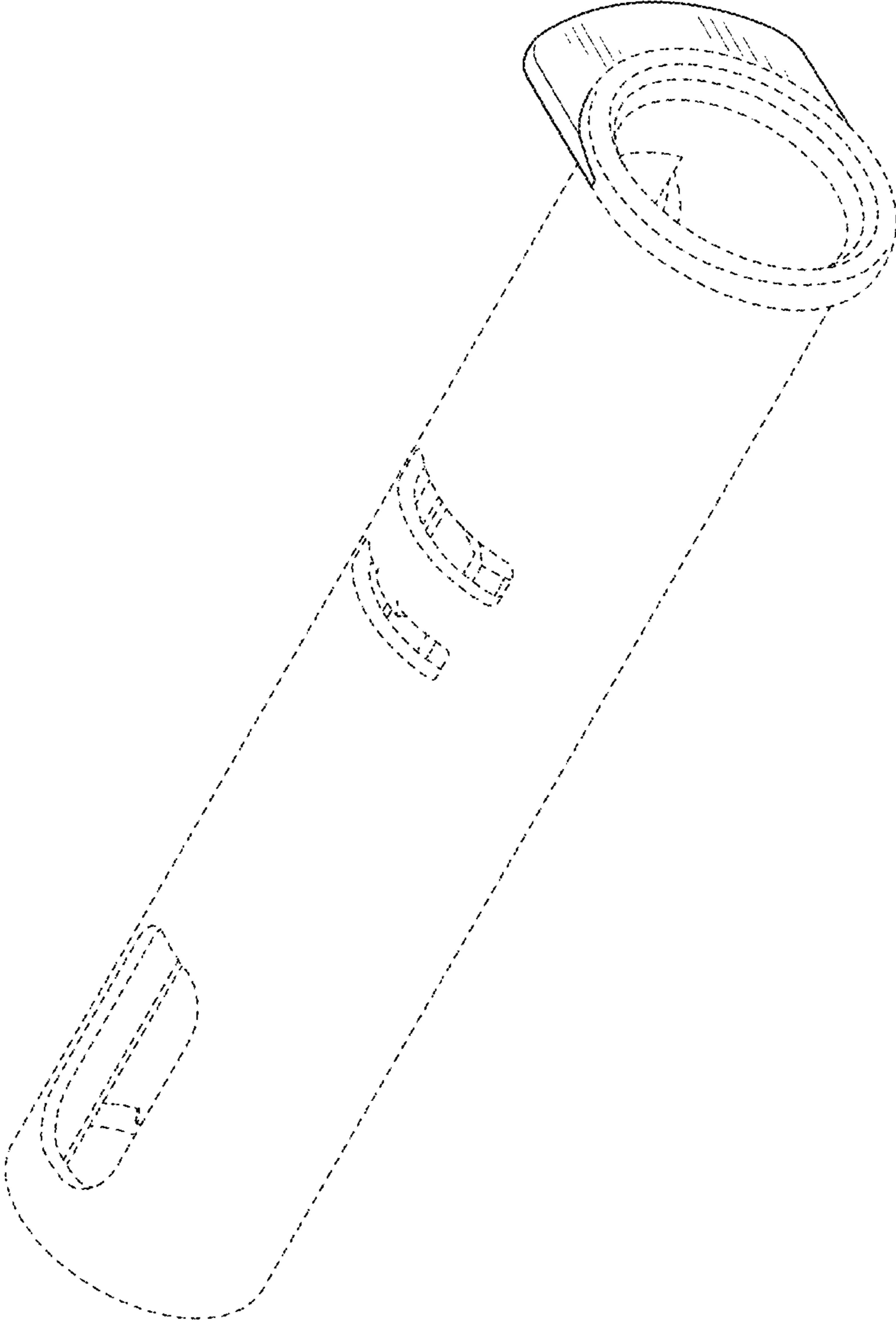

FIG. 1

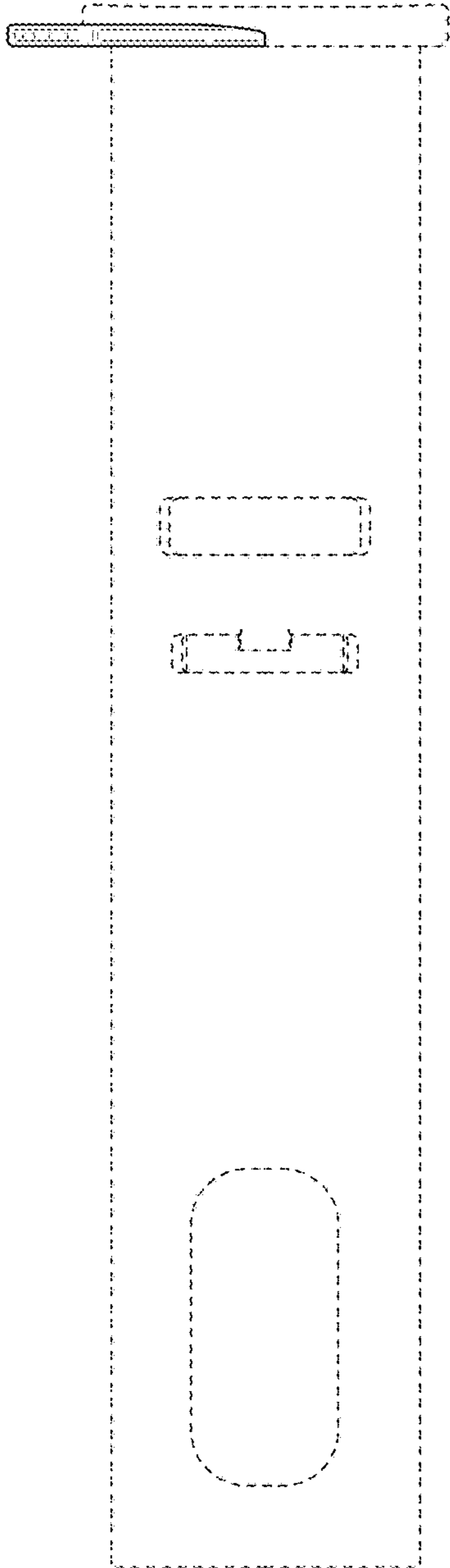

FIG. 2

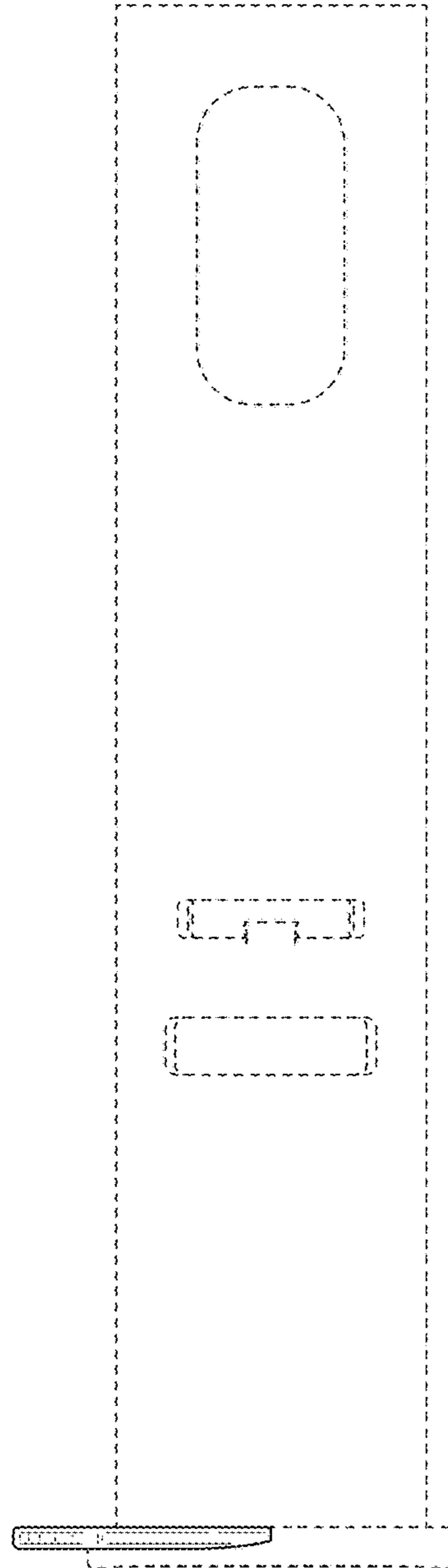

FIG. 3

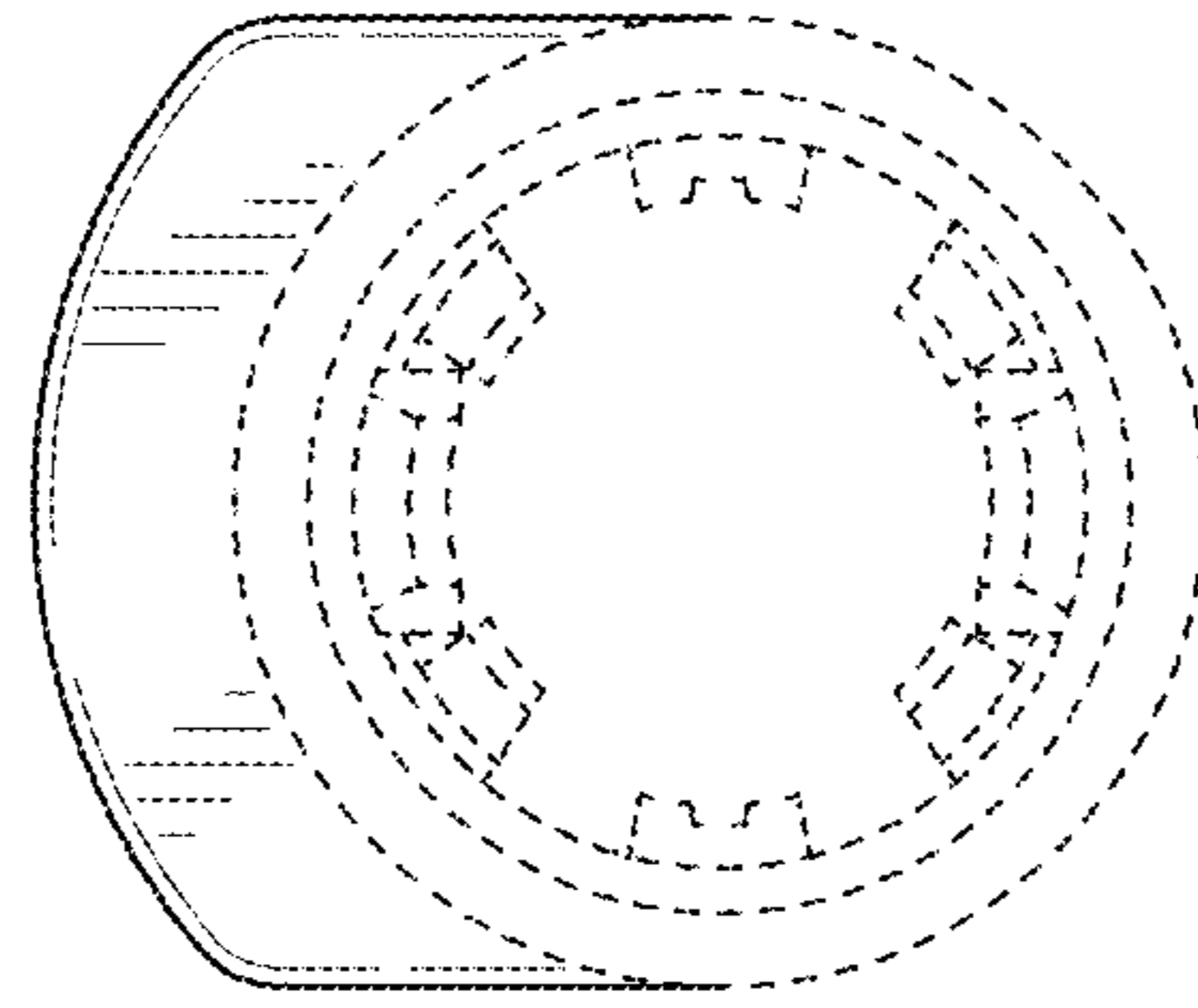

FIG. 5

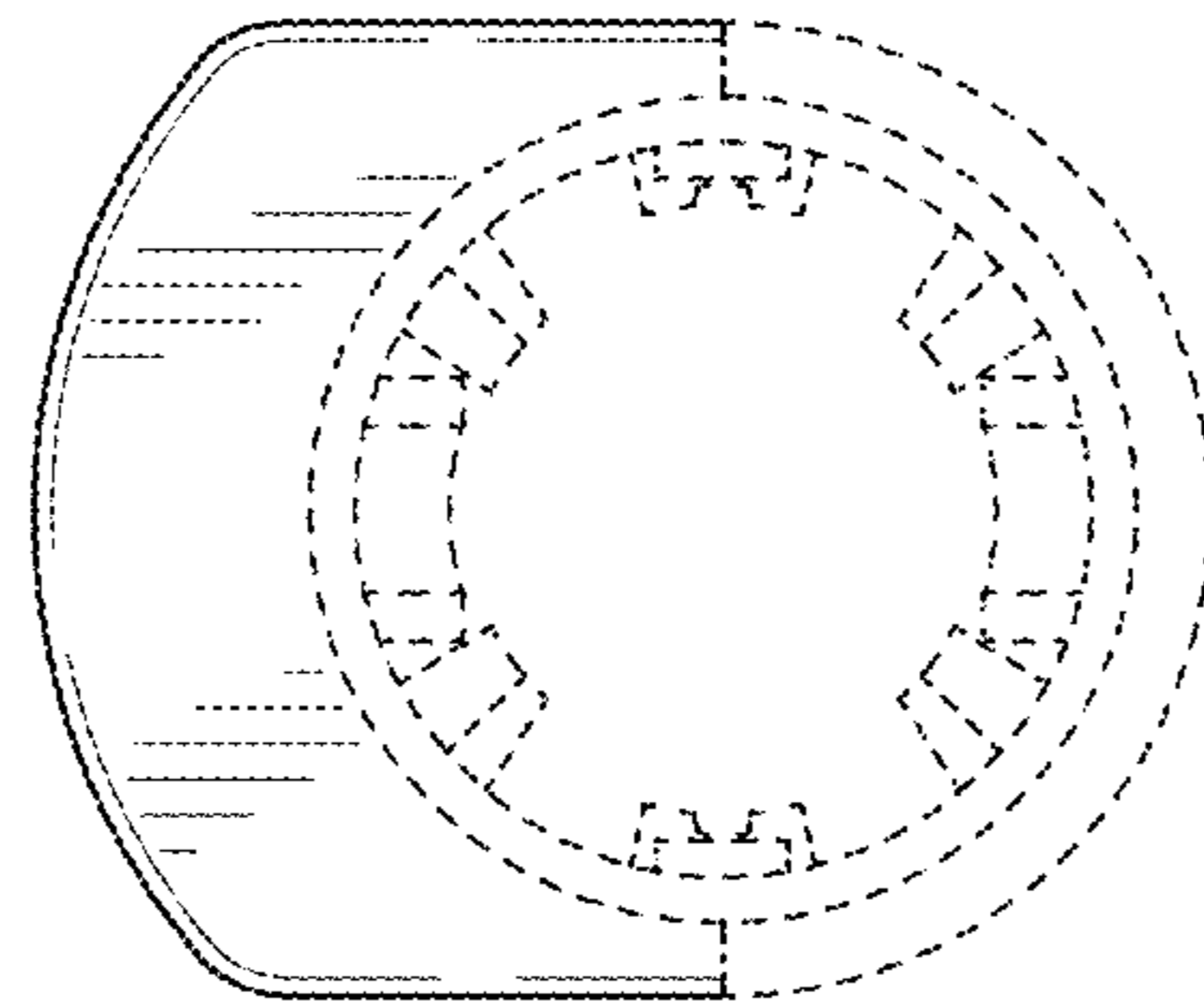

FIG. 4

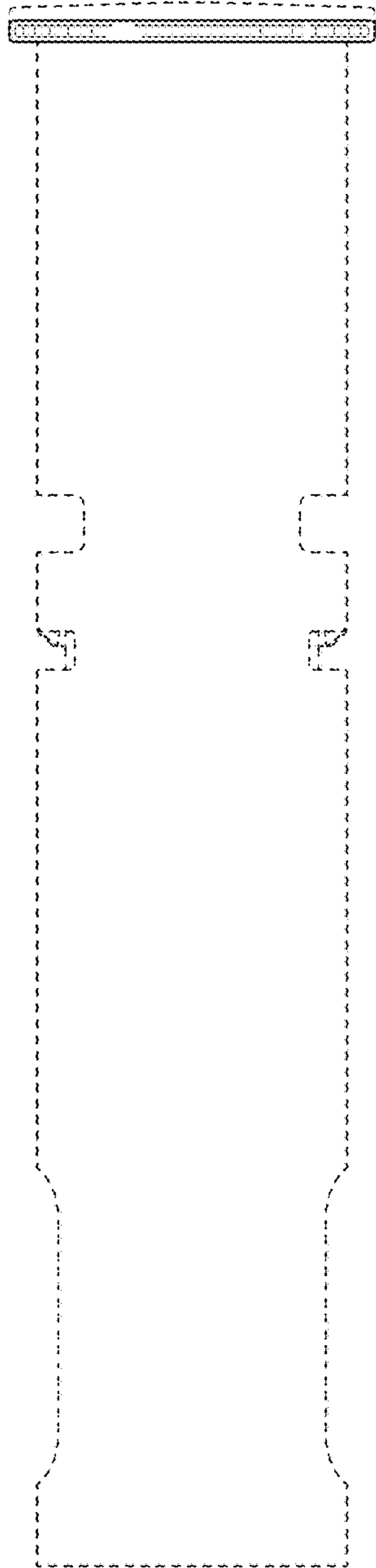

FIG. 6

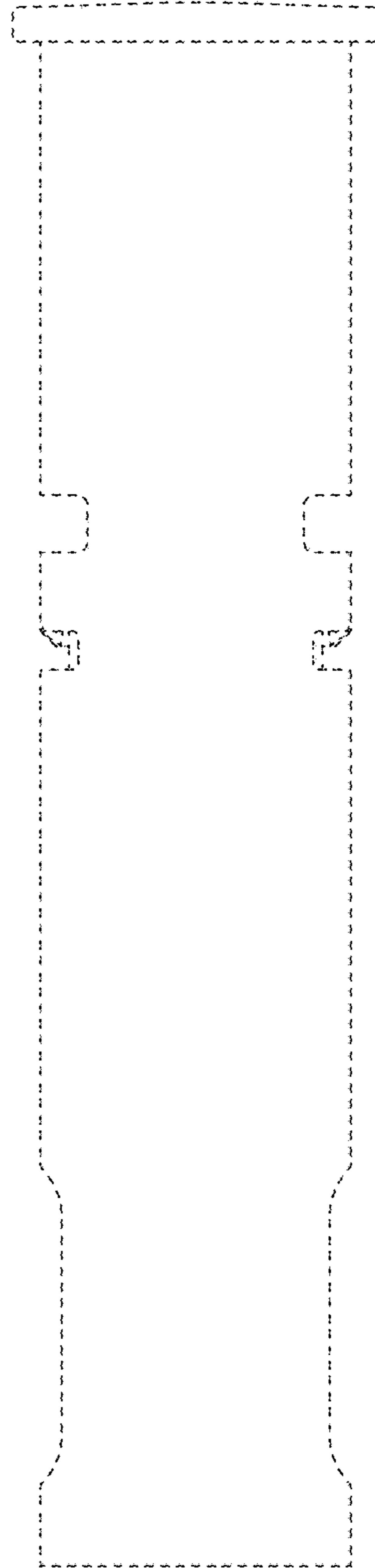

FIG. 7

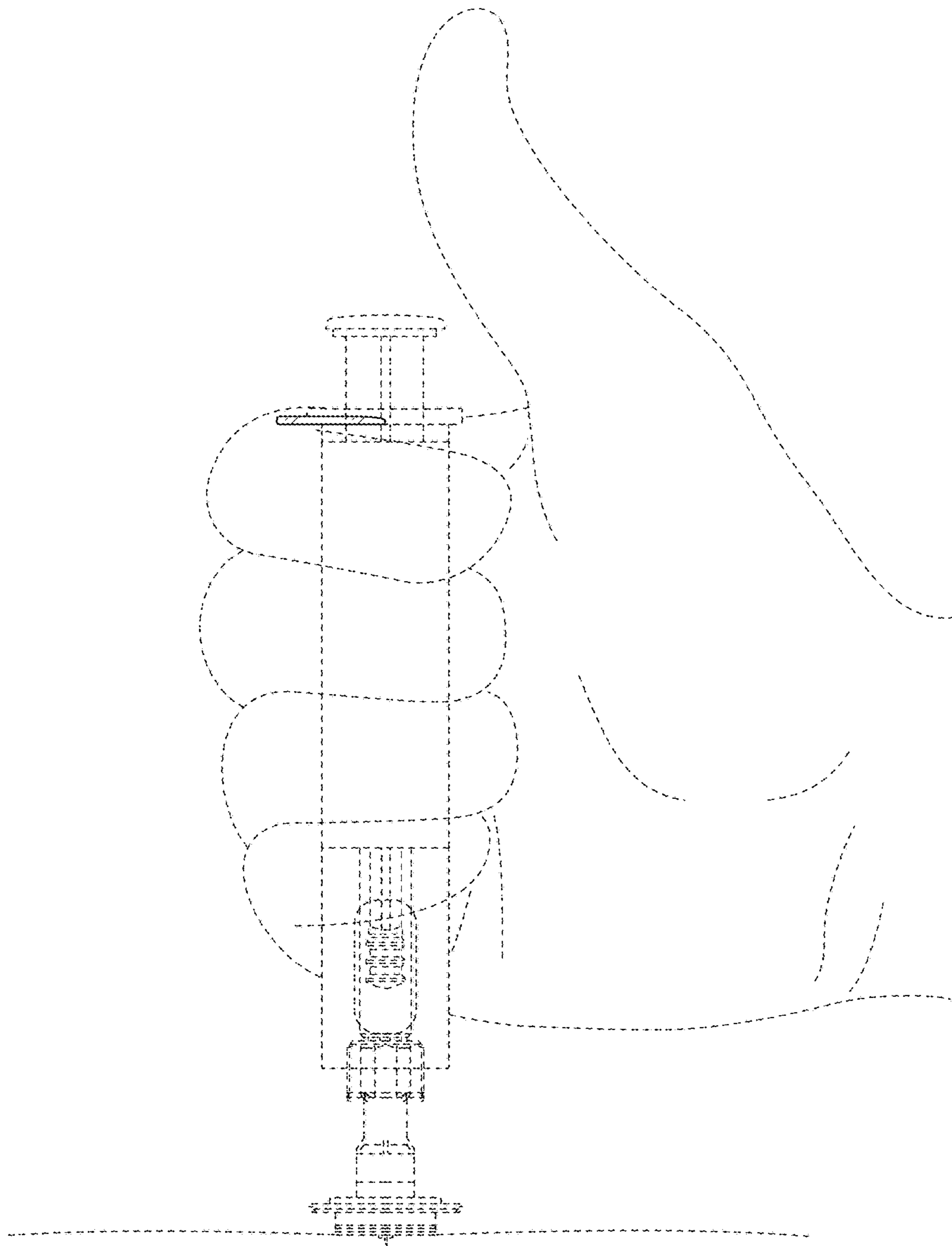

FIG. 8