



US00D787597S

(12) **United States Design Patent**  
**Kang**

(10) **Patent No.:** **US D787,597 S**

(45) **Date of Patent:** **\*\* \*May 23, 2017**

- (54) **ELECTRONIC LABEL**
- (71) Applicant: **SOLUM CO., LTD.**, Suwon-Si (KR)
- (72) Inventor: **Chul Min Kang**, Suwon-Si (KR)
- (73) Assignee: **SOLUM CO., LTD.**, Suwon-si (KR)

D475,407 S *	6/2003	Beno .....	D19/113
D510,109 S *	9/2005	Cobb .....	D20/42
D589,089 S *	3/2009	Loerakker .....	D19/113
D652,083 S *	1/2012	Yi .....	D20/42
D754,256 S *	4/2016	Maman .....	D20/43

- (\*) Notice: This patent is subject to a terminal disclaimer.
- (\*\*) Term: **14 Years**

**FOREIGN PATENT DOCUMENTS**

EM	001347959	1/2013
KR	30-1994-0019238	12/1995
KR	30-2002-0005613	6/2002

\* cited by examiner

- (21) Appl. No.: **29/526,161**
- (22) Filed: **May 7, 2015**

*Primary Examiner* — Mary Ann Calabrese

(74) *Attorney, Agent, or Firm* — NSIP Law

(30) **Foreign Application Priority Data**

Mar. 4, 2015 (KR) ..... 30-2015-0010950

(51) **LOC (10) Cl.** ..... **19-08**

(52) **U.S. Cl.**  
USPC ..... **D20/27**

(58) **Field of Classification Search**  
USPC ..... D20/10, 19, 22, 27, 42, 43, 99; D6/300;  
D19/113  
CPC ..... G09F 3/00; G09F 3/0335; G09F 3/204;  
G09F 3/00208; G09F 9/00; G09F 13/00;  
H05K 5/0204  
See application file for complete search history.

(57) **CLAIM**

I claim the ornamental design for an electronic label, as shown and described.

(56) **References Cited**

**U.S. PATENT DOCUMENTS**

6,148,556 A *	11/2000	Seki .....	G09F 3/204
			40/594
D452,081 S *	12/2001	Rowan .....	D6/300

**DESCRIPTION**

FIG. 1 is a front perspective view of an electronic label showing my new design;  
FIG. 2 is a front view thereof;  
FIG. 3 is a rear view thereof;  
FIG. 4 is a left-side view thereof;  
FIG. 5 is a right-side view thereof;  
FIG. 6 is a top view thereof; and,  
FIG. 7 is a bottom view thereof.

The broken lines in the figures show portions of the electronic label which form no part of the claimed design. The dot-dash broken lines in the figures represent an unclaimed boundary line and form no part of the claimed design.

**1 Claim, 5 Drawing Sheets**

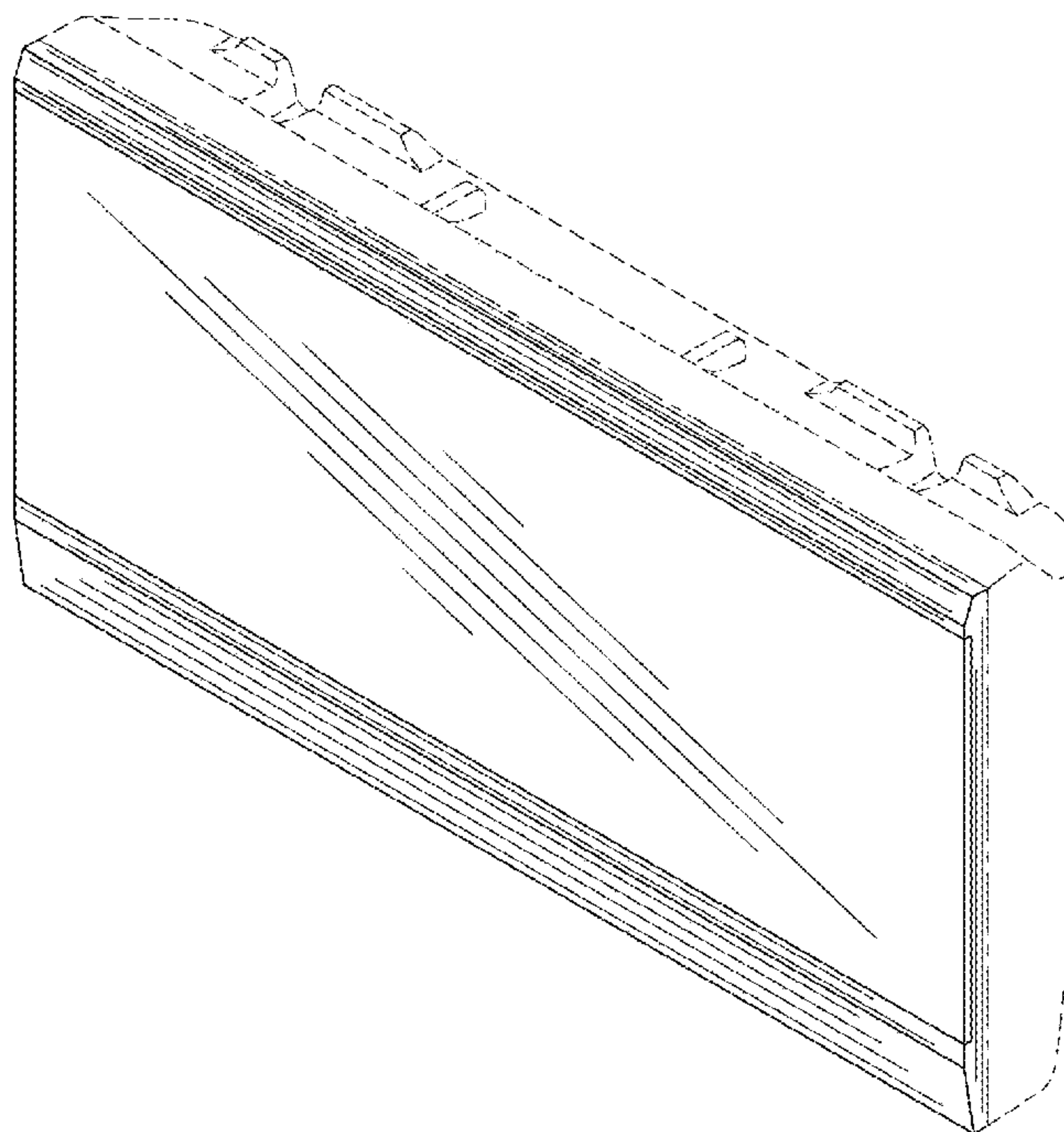

FIG. 1

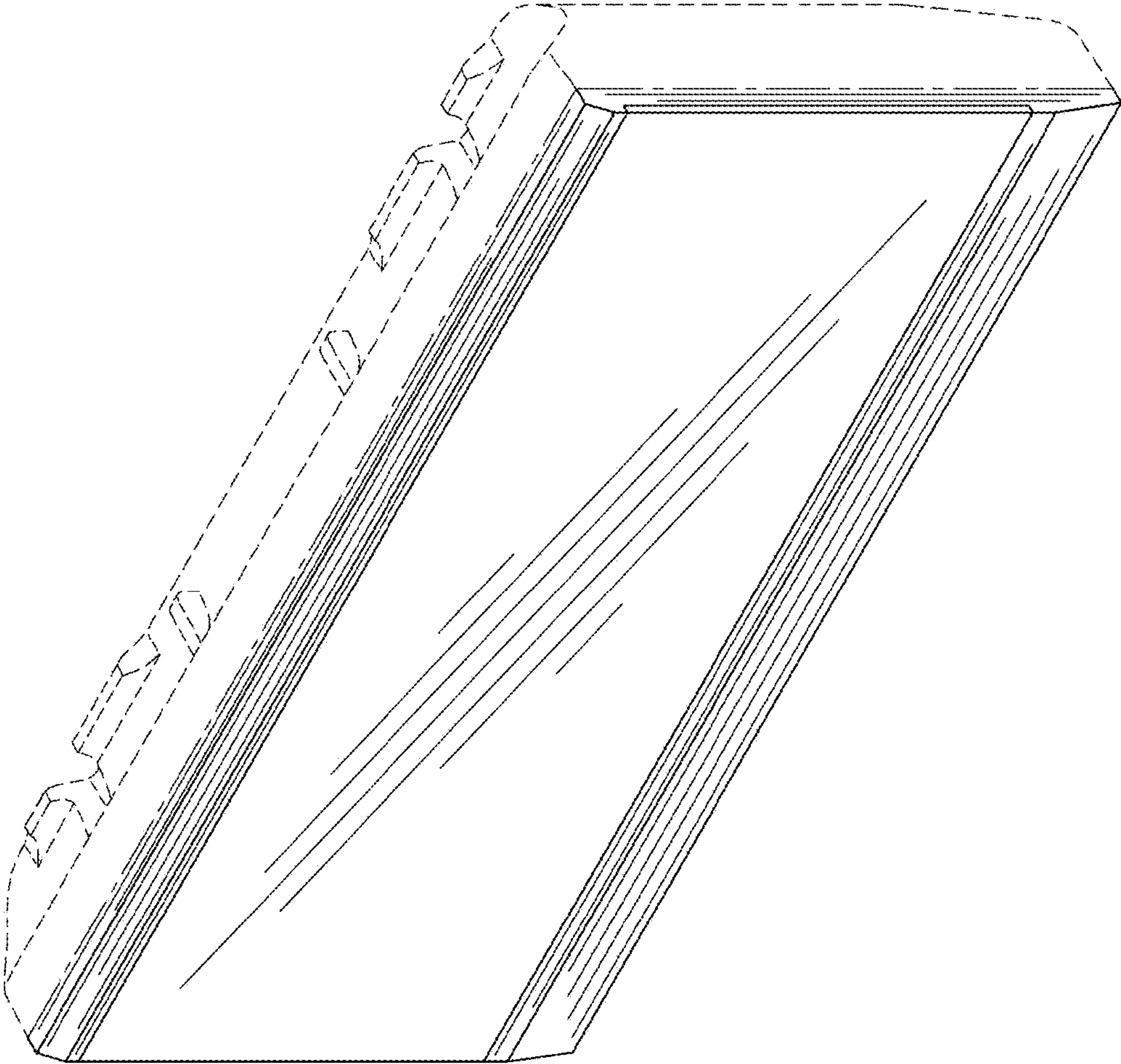

FIG. 2

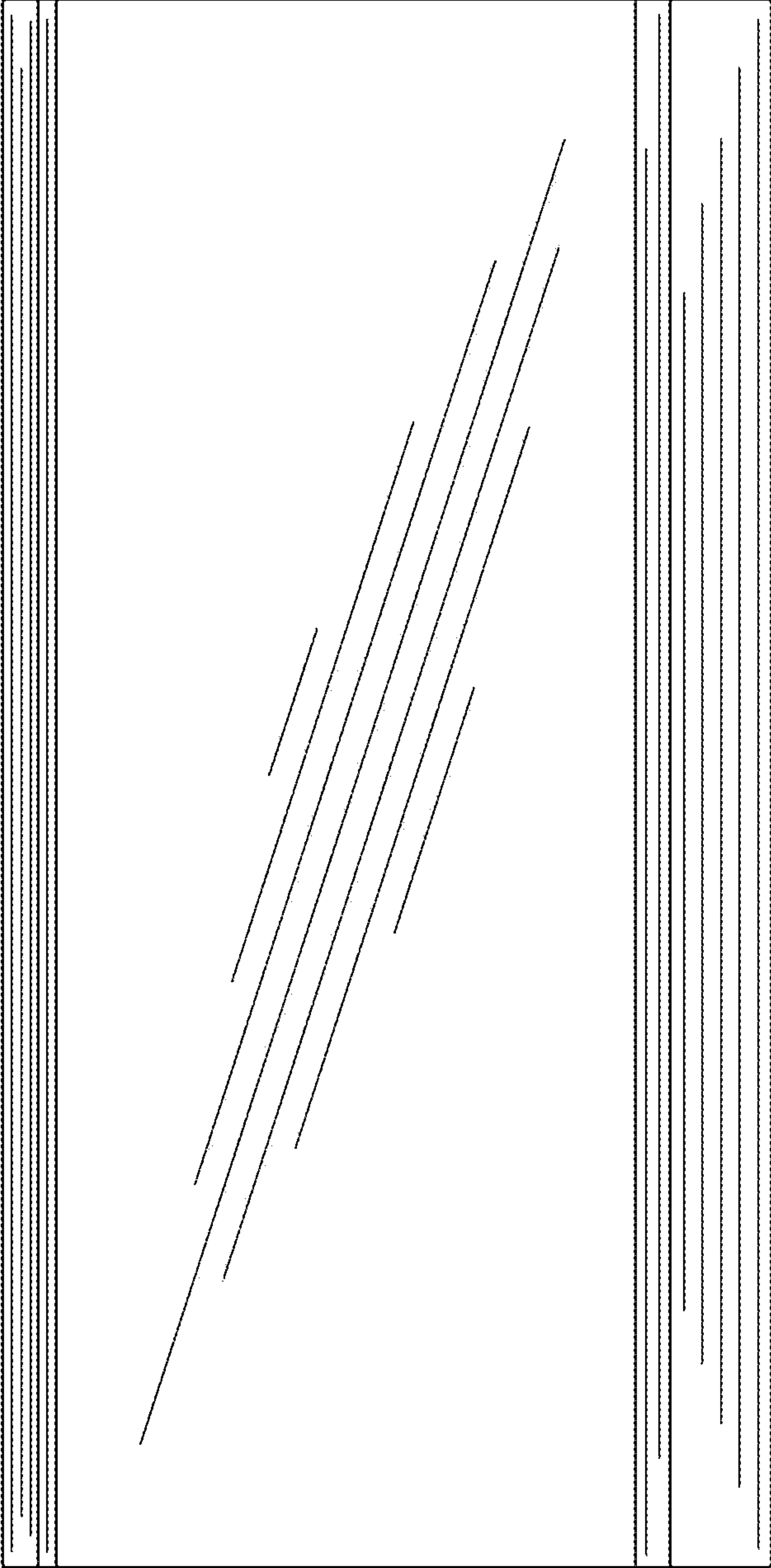

FIG. 3

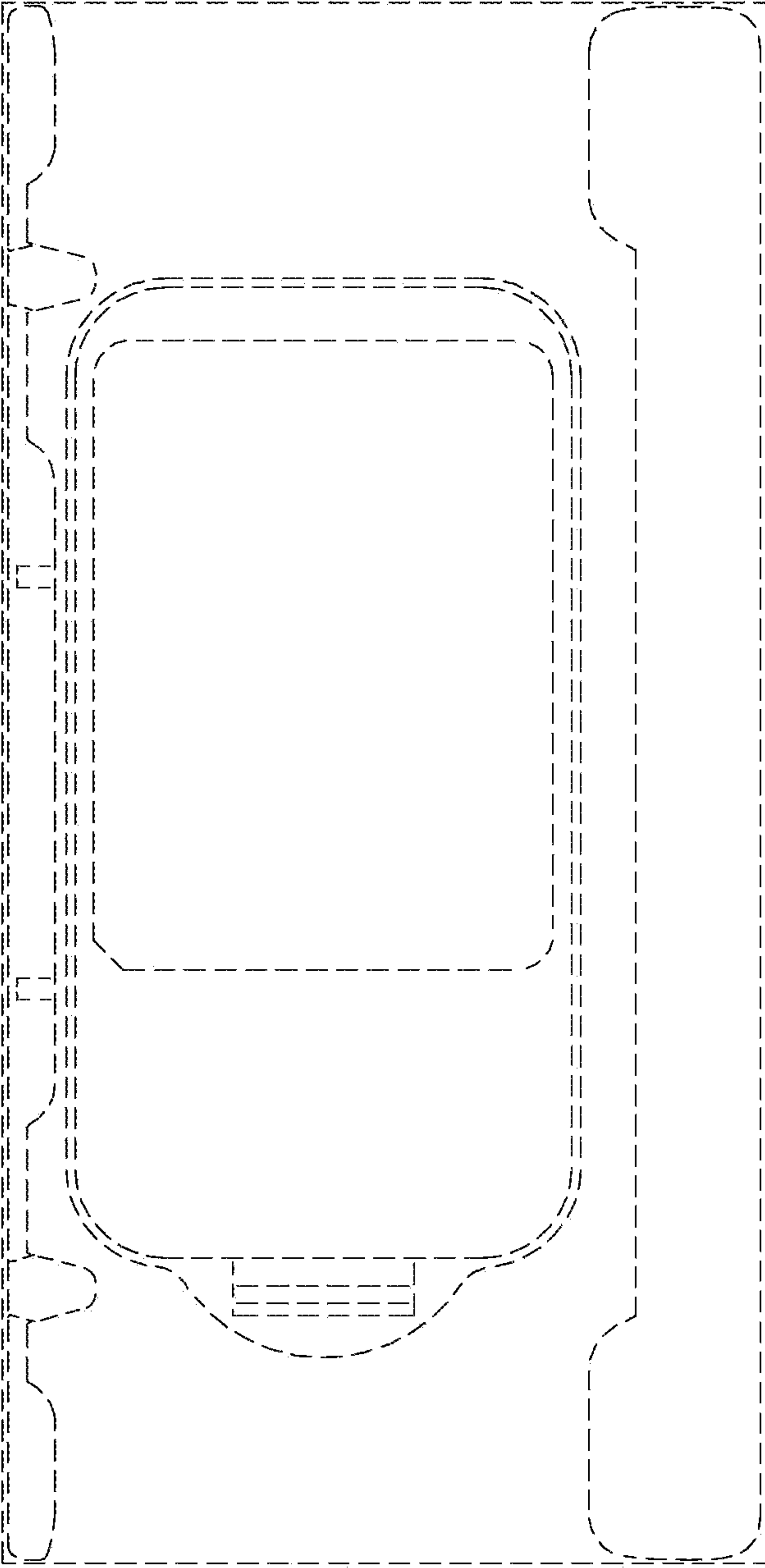

FIG. 5

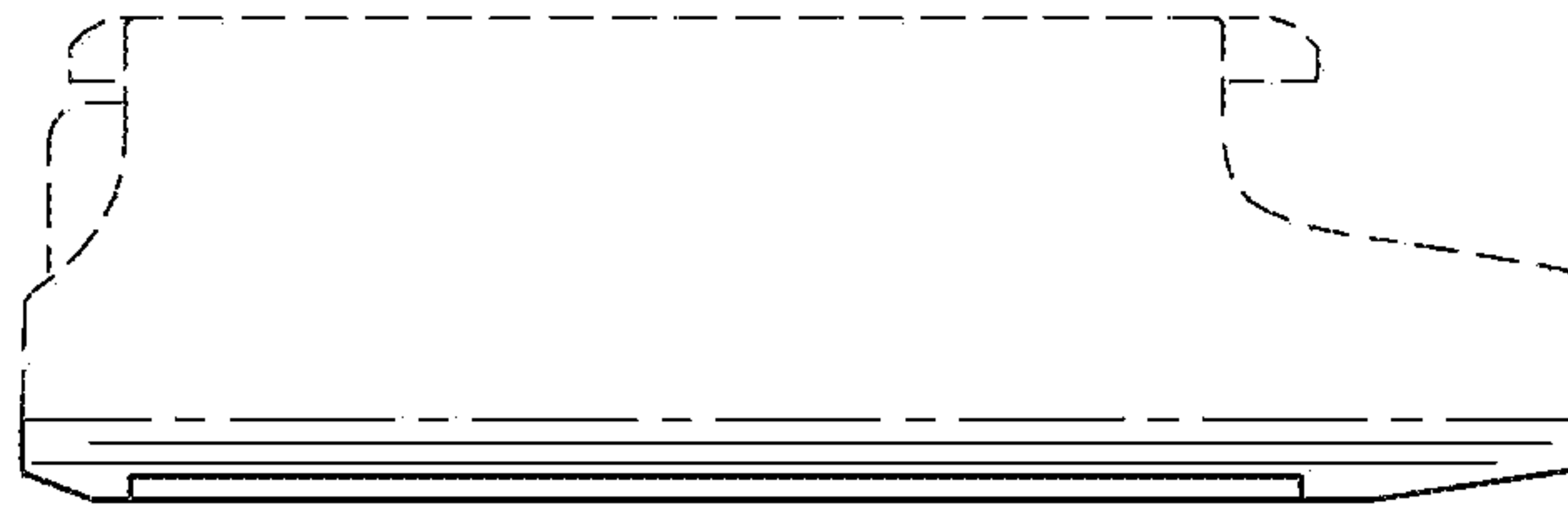

FIG. 4

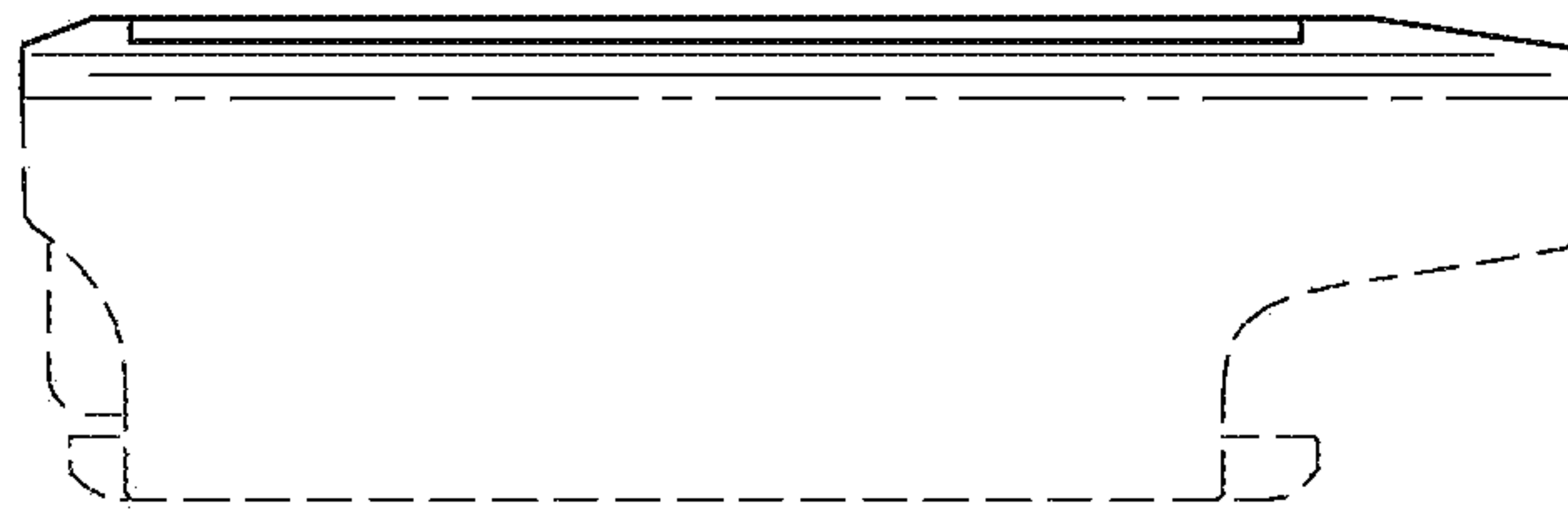

FIG. 6

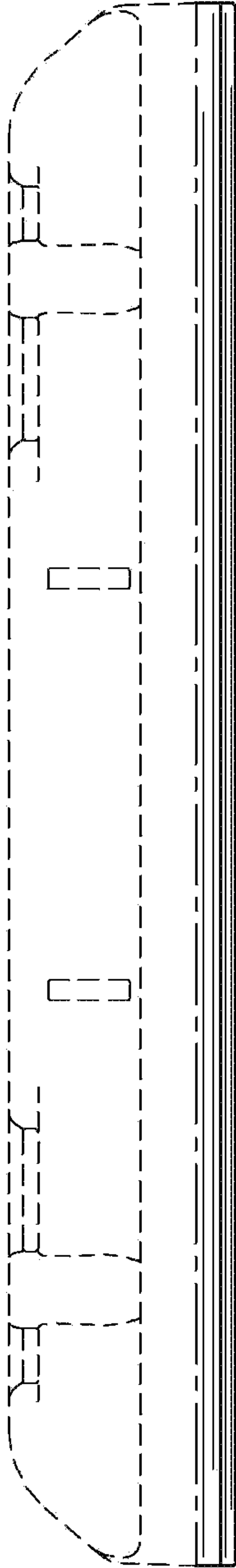

FIG. 7

