



US00D787464S

(12) **United States Design Patent** (10) **Patent No.:** **US D787,464 S**
Kim (45) **Date of Patent:** **** May 23, 2017**

(54) **MOBILE TERMINAL**

(71) Applicant: **Samsung Electronics Co., Ltd.**,
Suwon-si (KR)

(72) Inventor: **Hak-Do Kim**, Seoul (KR)

(73) Assignee: **Samsung Electronics Co., Ltd.**,
Suwon-si (KR)

(**) Term: **14 Years**

(21) Appl. No.: **29/499,106**

(22) Filed: **Aug. 12, 2014**

(30) **Foreign Application Priority Data**

May 28, 2014 (KR) 30-2014-0026256

(51) **LOC (10) Cl.** **14-03**

(52) **U.S. Cl.**
USPC **D14/138 G**

(58) **Field of Classification Search**

USPC D14/138 G, 138 AD, 341, 138 R, 496,
D14/203.1, 203.3, 203.5, 203.7, 144, 250;
455/575.1, 556.2, 575.3, 575.4; D21/517,
D21/329; 379/433.01, 433.04;
361/679.3, 679.56

CPC .. G06F 1/1626; H04M 1/0266; H04M 1/0202
See application file for complete search history.

(56) **References Cited**

U.S. PATENT DOCUMENTS

D650,349 S * 12/2011 Tom D14/138 G
D650,766 S * 12/2011 Hong D14/138 G
D652,404 S * 1/2012 Okada D14/138 G
D656,917 S * 4/2012 Tom D14/138 G
D657,336 S * 4/2012 Nilsen D14/138 G
D663,724 S * 7/2012 Lee D14/248
D672,767 S * 12/2012 Yoneya D14/341

(Continued)

OTHER PUBLICATIONS

Galaxy S5 Active vs Galaxy S5, published on YouTube May 21, 2014, Total Tech, [online], [site visited Sep. 20, 2016]. Available from Internet, <URL:https://www.youtube.com/watch?v=U4t-YI_IGOU>.*

(Continued)

Primary Examiner — Jeffrey D Asch

(74) *Attorney, Agent, or Firm* — NSIP Law

(57) **CLAIM**

I claim the ornamental design for a mobile terminal, as shown and described.

DESCRIPTION

FIG. 1 is a front perspective view of a mobile terminal showing my new design;
FIG. 2 is a front view thereof;
FIG. 3 is a rear view thereof;
FIG. 4 is a left-side view thereof;
FIG. 5 is a right-side view thereof;
FIG. 6 is a top view thereof;
FIG. 7 is a bottom view thereof;
FIG. 8 is a rear perspective view thereof;
FIG. 9 is an enlarged view of the encircled portion in FIG. 1; and,
FIG. 10 is an enlarged view of the encircled portion in FIG. 8.

The broken lines shown in the figures that are immediately adjacent to the shaded areas and define unshaded regions represent the bounds of the claim. All other broken lines, that is, the features within broken line boundaries and the tiny circles at either side of the speaker, are directed to environment. The broken lines form no part of the claimed design. The dot-dash broken lines encircling portions of the claimed design that are illustrated in enlargements form no part of the claimed design.

1 Claim, 8 Drawing Sheets

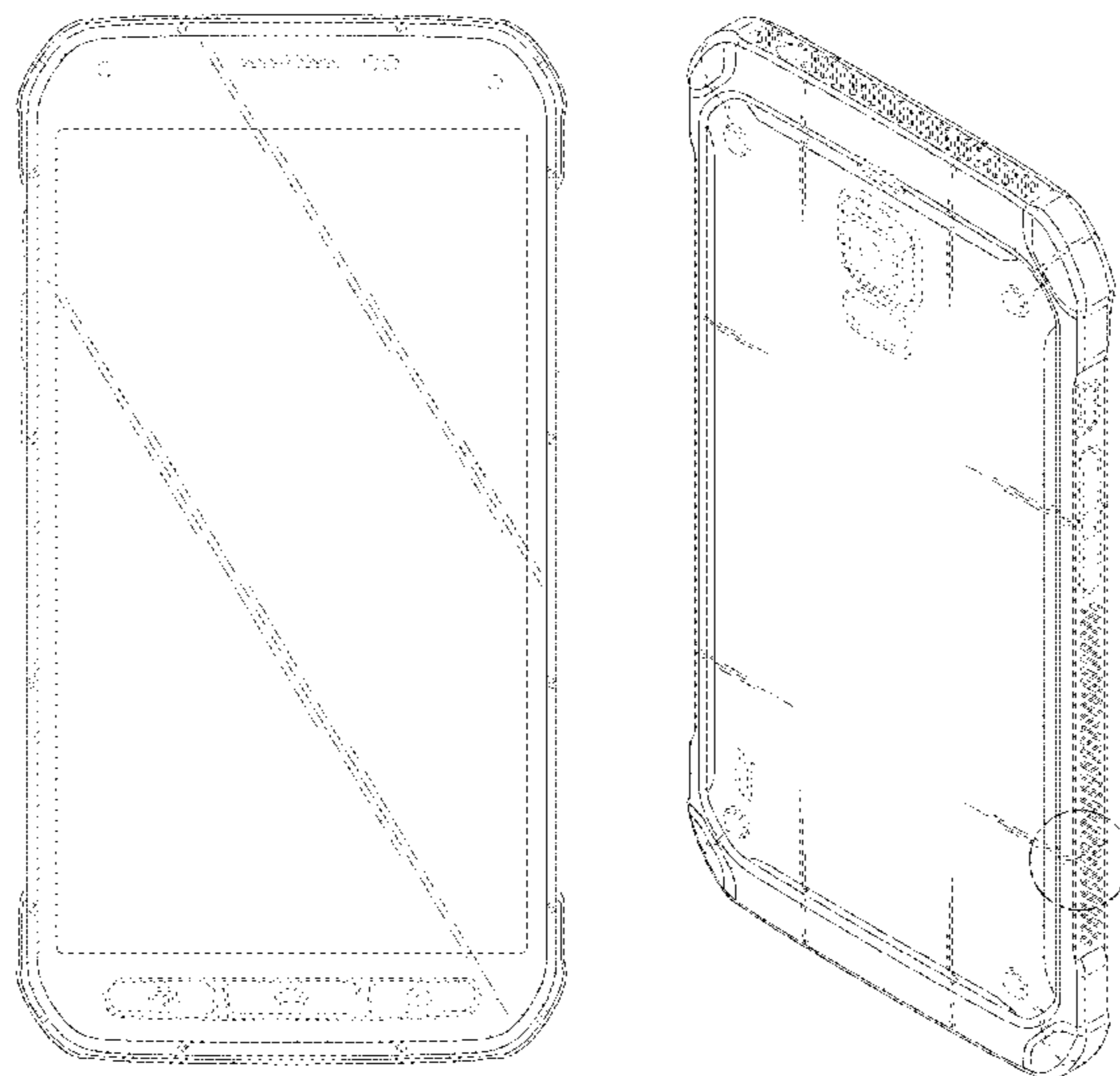

(56)

References Cited

OTHER PUBLICATIONS

U.S. PATENT DOCUMENTS

D673,924 S * 1/2013 Mitchell D14/138 G
 D680,984 S * 4/2013 Harmon D14/138 G
 D688,221 S * 8/2013 Zuffo D14/138 G
 D691,576 S * 10/2013 Lee D14/138 G
 D694,213 S * 11/2013 Park D14/138 G
 D701,203 S * 3/2014 Katori D14/341
 D705,747 S * 5/2014 Boucquey D14/138 G
 D707,644 S * 6/2014 Asano D14/138 G
 D712,864 S * 9/2014 Hirota D14/138 G
 D715,245 S * 10/2014 Meneses D14/138 G
 D716,294 S * 10/2014 Park D14/341
 D717,781 S * 11/2014 Kim D14/250
 D718,758 S * 12/2014 Jaffee D14/250
 D719,151 S * 12/2014 Hirayama D14/341
 D721,051 S * 1/2015 Lee D14/138 G
 D723,495 S * 3/2015 Jeong D14/138 G
 D743,392 S * 11/2015 Ju D14/341
 9,270,795 B2 * 2/2016 Endo H01Q 1/243
 9,317,066 B2 * 4/2016 Mochizuki G06F 1/1626
 2013/0036377 A1 * 2/2013 Colley G06F 3/0488
 715/764
 2013/0303241 A1 * 11/2013 Coker H04M 1/0254
 455/566
 2016/0050302 A1 * 2/2016 Lee H04B 1/3888
 455/575.1
 2016/0127523 A1 * 5/2016 Rouaissia H04M 1/0266
 455/566
 2016/0127524 A1 * 5/2016 Kanemaki H04M 1/03
 455/575.1

Samsung GalaxyS5 Active, Released May 2014, [online], [site visited Sep. 20, 2016]. Available from Internet, <URL: http://www.gsmarena.com/samsung_galaxy_s5_active-6356.php>.*
 Samsung Rugby Smart I847, Released Mar. 2012, [online], [site visited Sep. 20, 2016]. Available from Internet, <URL: http://www.gsmarena.com/samsung_rugby_smart_i847-4564.php>.*
 Samsung Galaxy Xcover 3, Released Apr. 2015, [online], [site visited Sep. 20, 2016]. Available from Internet, <URL: http://www.gsmarena.com/samsung_galaxy_xcover_3-6990.php>.*
 Samsung Galaxy S5 Sport, Released Jun. 2014, [online], [site visited Sep. 20, 2016]. Available from Internet, <URL: http://www.gsmarena.com/samsung_galaxy_s5_sport-6460.php>.*
 Samsung Galaxy S6 active, Released Jun. 2015, [online], [site visited Sep. 20, 2016]. Available from Internet, <URL: http://www.gsmarena.com/samsung_galaxy_s6_active-7114.php>.*
 Samsung Galaxy Tab Active LTE, Released Dec. 2014, [online], [site visited Sep. 20, 2016]. Available from Internet, <URL: http://www.gsmarena.com/samsung_galaxy_tab_active_lte-6658.php>.*
 Cat S40, Released Aug. 2015, [online], [site visited Sep. 20, 2016]. Available from Internet, <URL: http://www.gsmarena.com/cat_s40-7456.php>.*
 Cat B15, Released 2013, [online], [site visited Sep. 20, 2016]. Available from Internet, <URL: http://www.gsmarena.com/cat_b15-5985.php>.*
 Samsung I9295 Galaxy S4 Active, Released Jun. 2013, [online], [site visited Sep. 20, 2016]. Available from Internet, <URL: http://www.gsmarena.com/samsung_i9295_galaxy_s4_active-5446.php>.*

* cited by examiner

FIG. 1

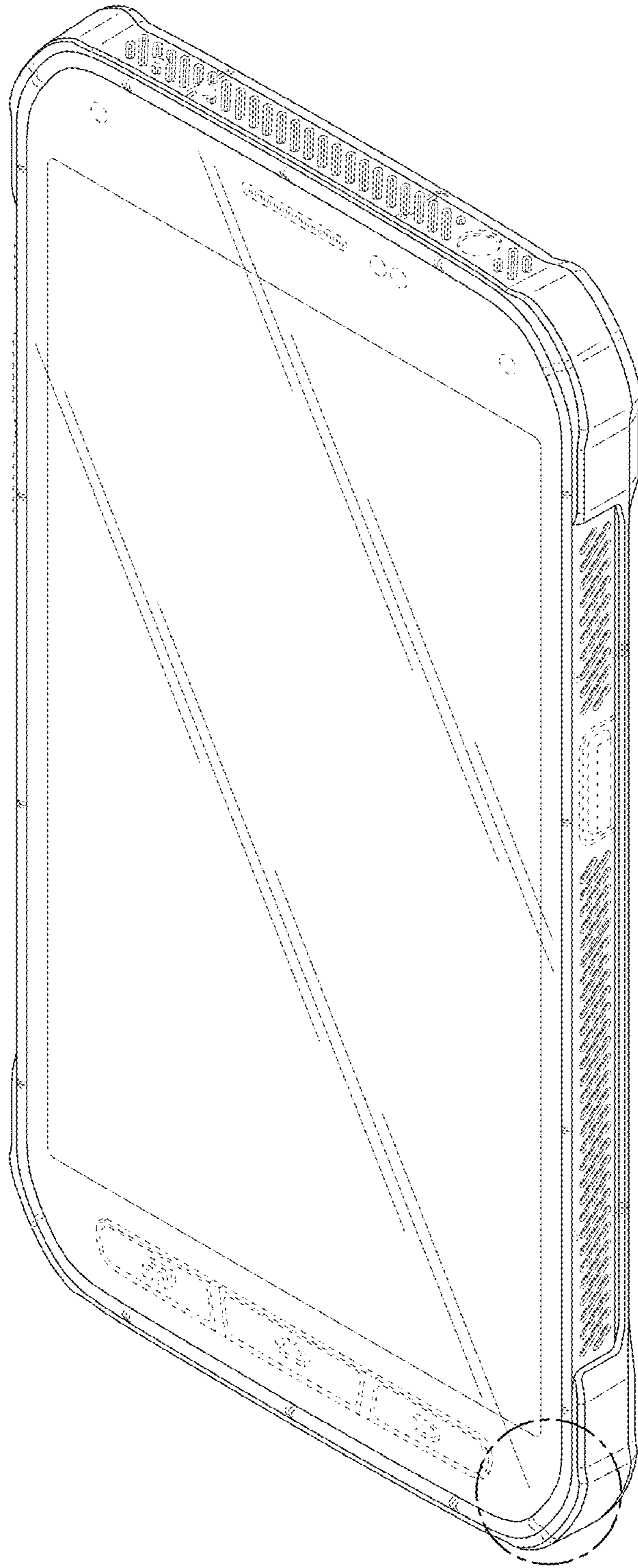

FIG. 2

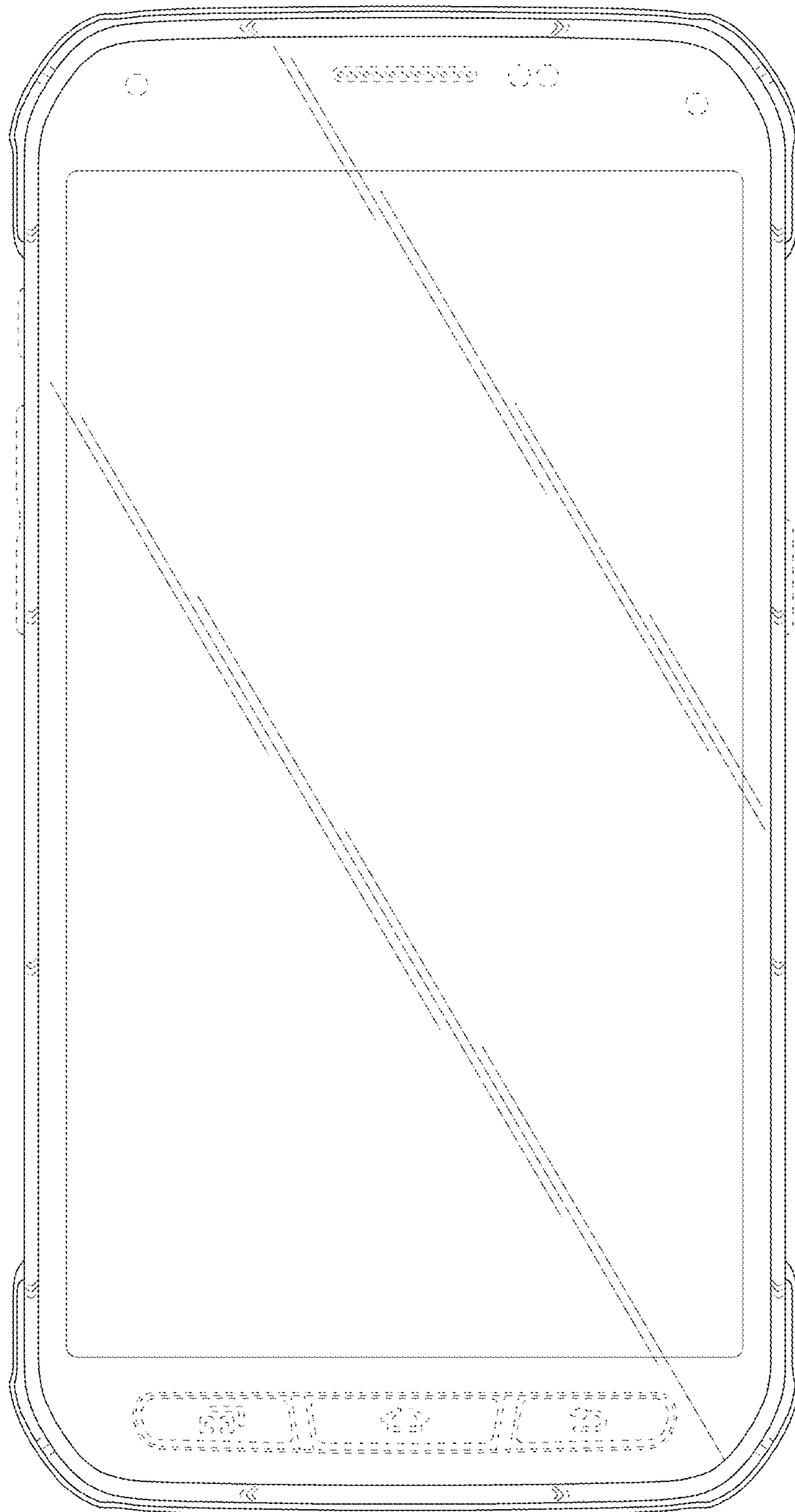

FIG. 3

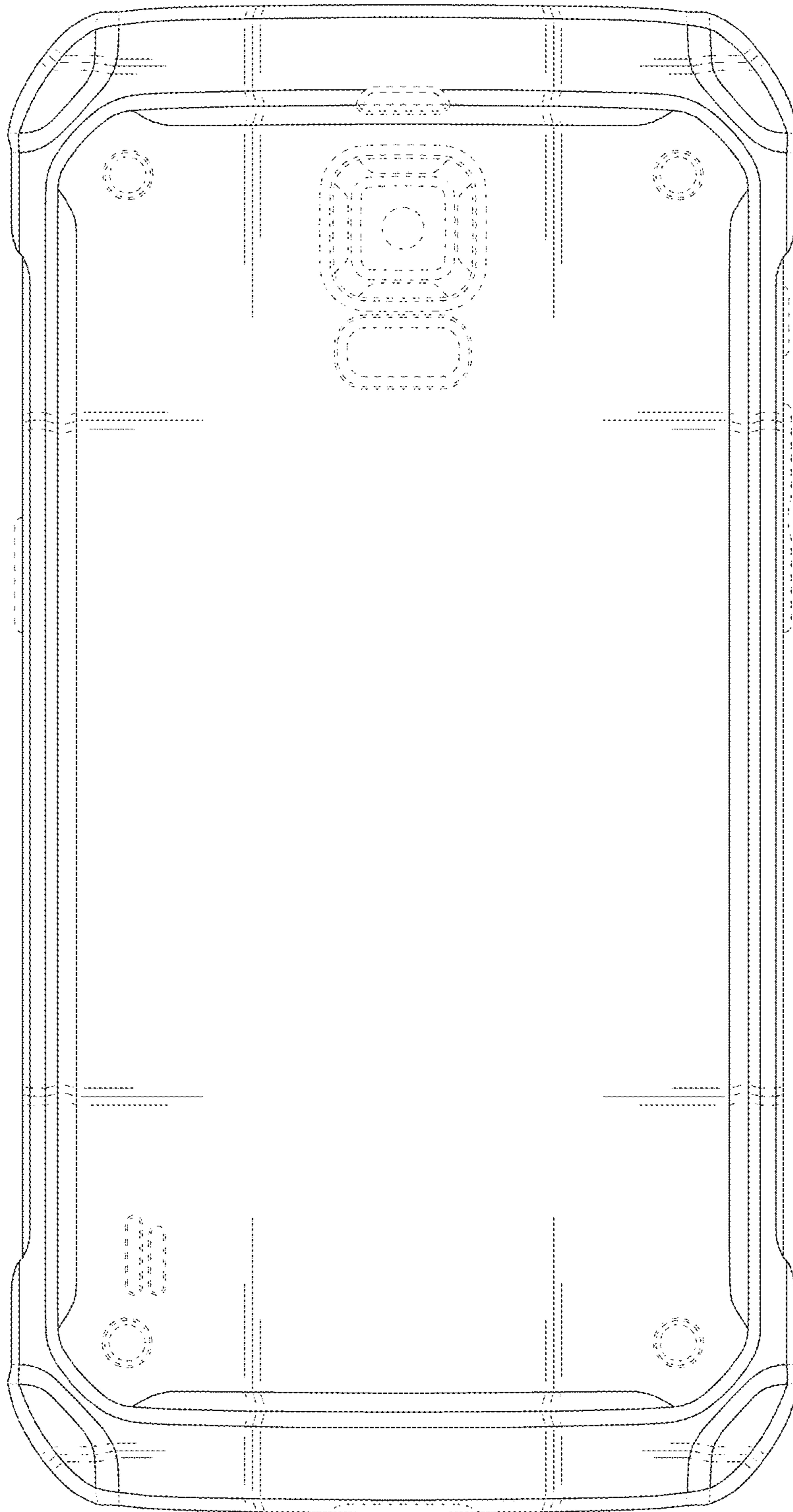

FIG. 4

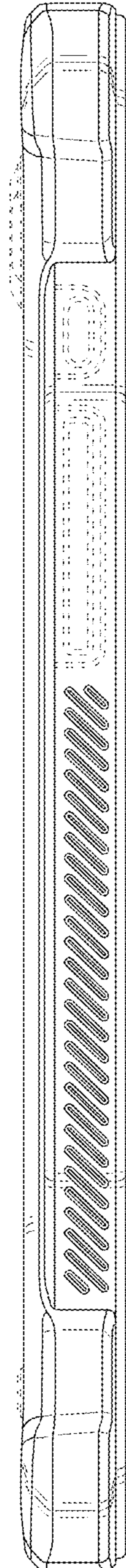

FIG. 5

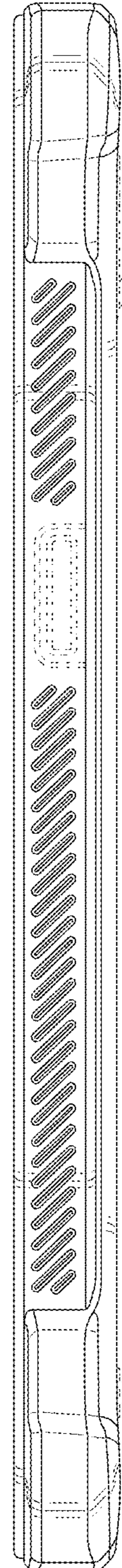

FIG. 6

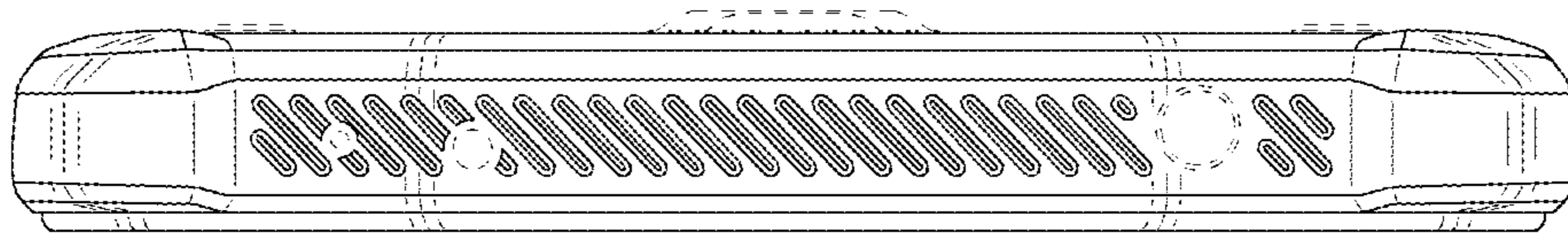

FIG. 7

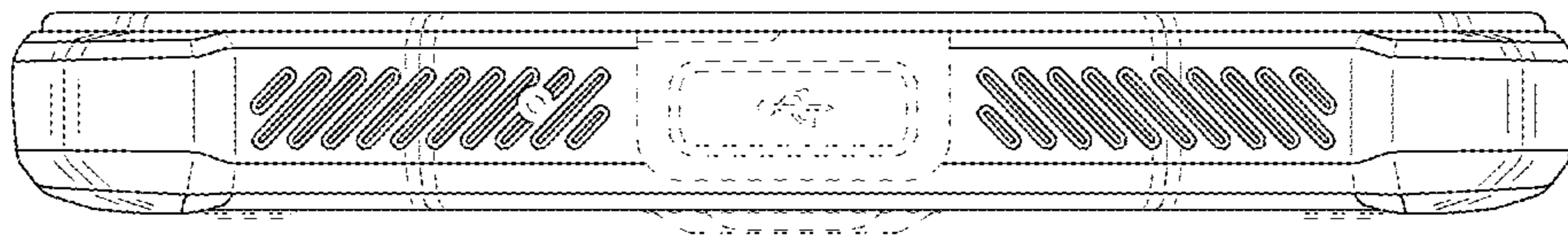

FIG. 8

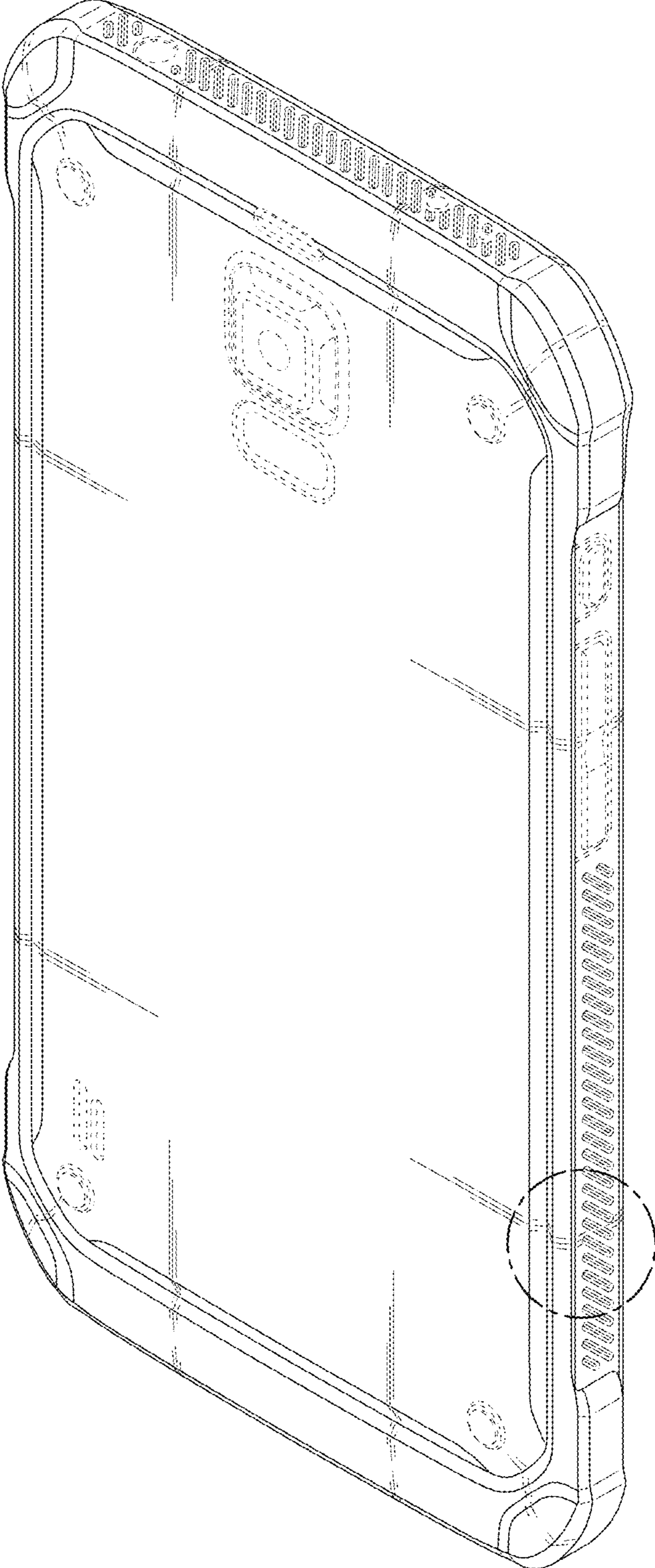

FIG. 9

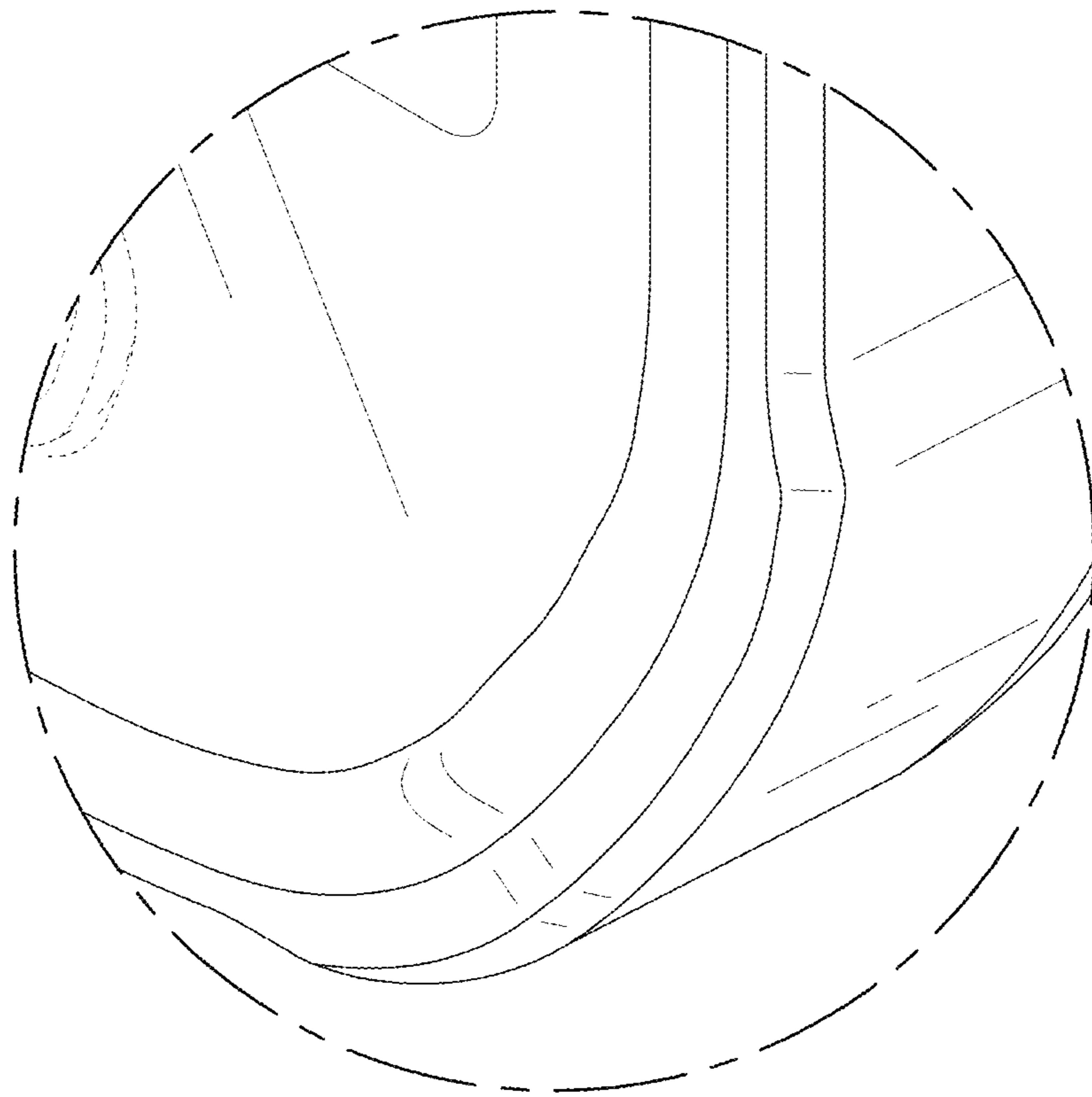

FIG. 10

