

US00D787299S

(12) **United States Design Patent** (10) **Patent No.:** **US D787,299 S**  
**Liu** (45) **Date of Patent:** **\*\* May 23, 2017**

(54) **SMART DOOR SENSOR**

6,145,353 A \* 11/2000 Doucet ..... E05B 47/0692  
70/149

(71) Applicants: **NANNING FUGUI PRECISION INDUSTRIAL CO., LTD.**, Nanning (CN); **HON HAI PRECISION INDUSTRY CO., LTD.**, New Taipei (TW)

(Continued)

*Primary Examiner* — Prabhakar Deshmukh  
(74) *Attorney, Agent, or Firm* — Steven Reiss

(72) Inventor: **Yao Liu**, Shenzhen (CN)

(57) **CLAIM**

(73) Assignees: **NANNING FUGUI PRECISION INDUSTRIAL CO., LTD.**, Nanning (CN); **HON HAI PRECISION INDUSTRY CO., LTD.**, New Taipei (TW)

The ornamental design for a smart door sensor, as shown and described.

(\*\*) Term: **15 Years**

**DESCRIPTION**

(21) Appl. No.: **29/553,333**

FIG. 1 is a perspective view of a smart door sensor showing my new design;

(22) Filed: **Jan. 31, 2016**

FIG. 2 is a front elevational view thereof;

(30) **Foreign Application Priority Data**

Sep. 25, 2015 (CN) ..... 2015 3 037591

FIG. 3 is a rear elevational view thereof;

(51) **LOC (10) Cl.** ..... **08-07**

FIG. 4 is a left side elevational view thereof;

(52) **U.S. Cl.**

USPC ..... **D8/331; D8/330; D8/350**

FIG. 5 is a right side elevational view thereof;

(58) **Field of Classification Search**

USPC ..... D8/330, 331, 334, 300, 301, 350; 70/14, 70/20-22, 57, 57.1, 284-286, 314, 70/DIG. 44, 266, 277, 271; 292/288-292

FIG. 6 is a top plan view thereof; and

CPC ..... E05B 9/00; E05B 9/02; E05B 2009/006; E05B 49/00; E05B 19/00; E05B 15/00; E05B 49/02; E05B 17/00; E05B 3/00

FIG. 7 is a bottom plan view thereof.

See application file for complete search history.

FIG. 8 is a perspective view of one of the component of FIG. 1, shown separately for clarity;

(56) **References Cited**

**U.S. PATENT DOCUMENTS**

3,041,720 A \* 7/1962 Pantas ..... E05B 15/02  
428/542.2  
5,433,333 A \* 7/1995 Martell ..... E01F 9/615  
220/243

FIG. 9 is a front elevational view of FIG. 8;

FIG. 10 is a rear elevational view of FIG. 8;

FIG. 11 is a left side elevational view of FIG. 8;

FIG. 12 is a right side elevational view of FIG. 8;

FIG. 13 is a top plan view of FIG. 8;

FIG. 14 is a bottom plan view of FIG. 8;

FIG. 15 is a perspective view of another component of FIG. 1, shown separately for clarity;

FIG. 16 is a front elevational view of FIG. 15;

FIG. 17 is a rear elevational view of FIG. 15;

FIG. 18 is a left side elevational view of FIG. 15;

FIG. 19 is a right side elevational view of FIG. 15;

FIG. 20 is a top plan view of FIG. 15; and,

FIG. 21 is a bottom plan view of FIG. 15.

The broken lines illustrate environment and form no part of the claimed design.

**1 Claim, 21 Drawing Sheets**

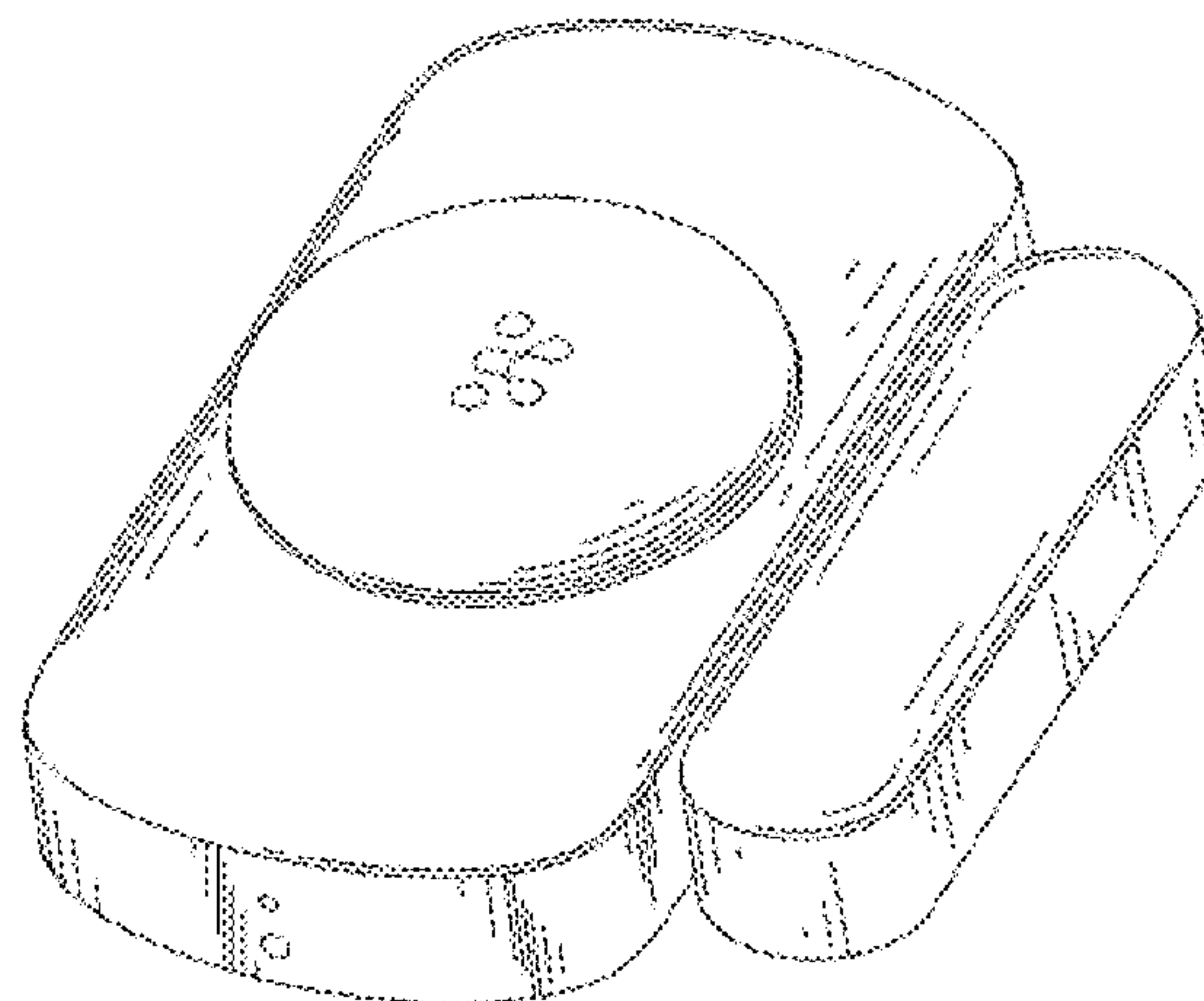

(56)

**References Cited**

U.S. PATENT DOCUMENTS

6,733,050 B1 \* 5/2004 Yao ..... E05B 63/044  
292/137  
6,828,519 B2 \* 12/2004 Bui ..... H01H 9/02  
174/53  
7,091,429 B2 \* 8/2006 Case ..... E05B 15/02  
200/314  
7,984,631 B2 \* 7/2011 Case ..... E05B 15/02  
70/278.1  
8,141,400 B2 \* 3/2012 Sorensen ..... E05B 47/068  
340/5.54  
D737,118 S \* 8/2015 Chan ..... D8/330  
D755,605 S \* 5/2016 Kraus ..... D8/331  
D760,064 S \* 6/2016 Aispuro ..... D8/350  
D767,365 S \* 9/2016 Yu ..... D8/330  
D768,463 S \* 10/2016 Kraus ..... D8/330

\* cited by examiner

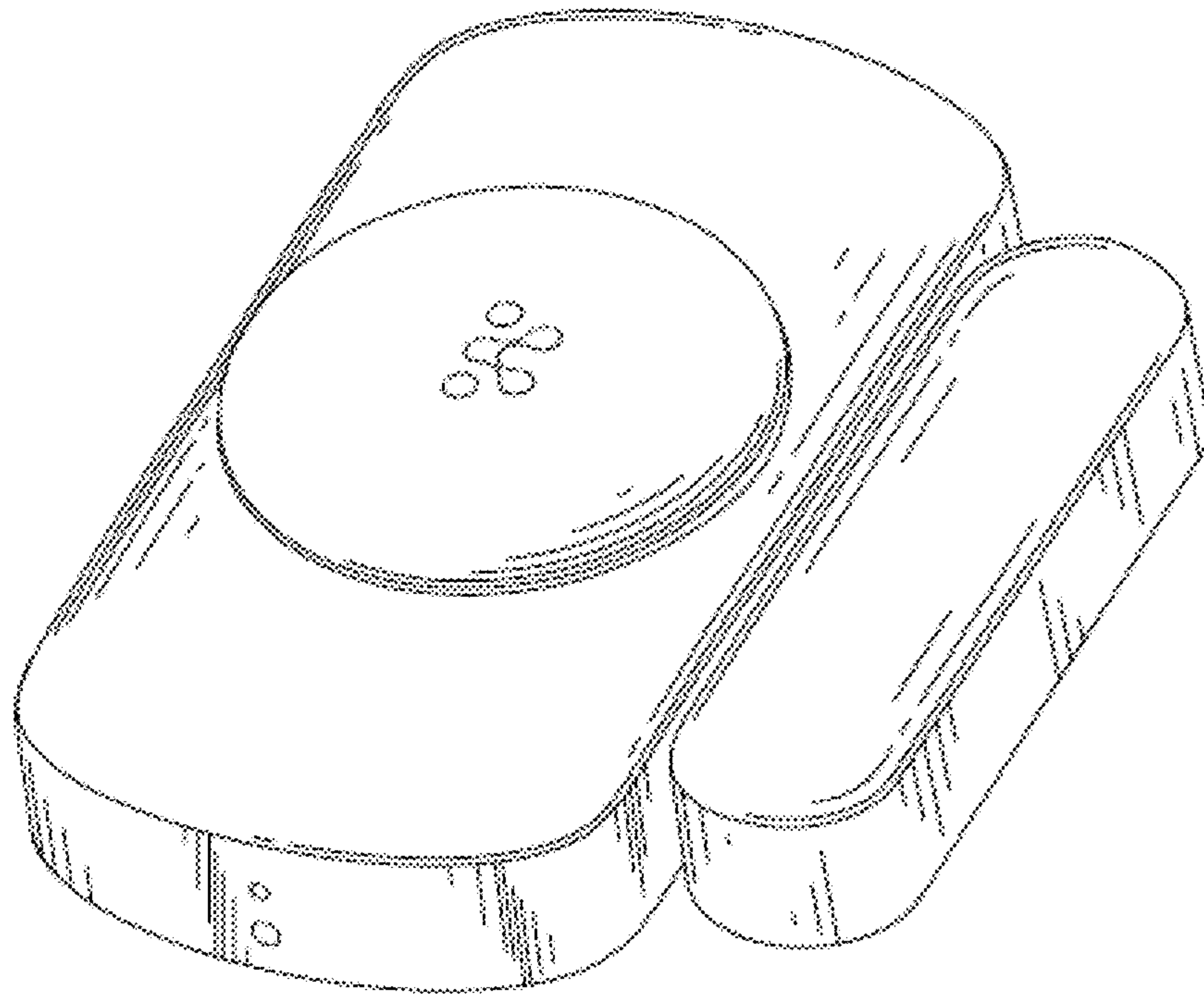

FIG. 1

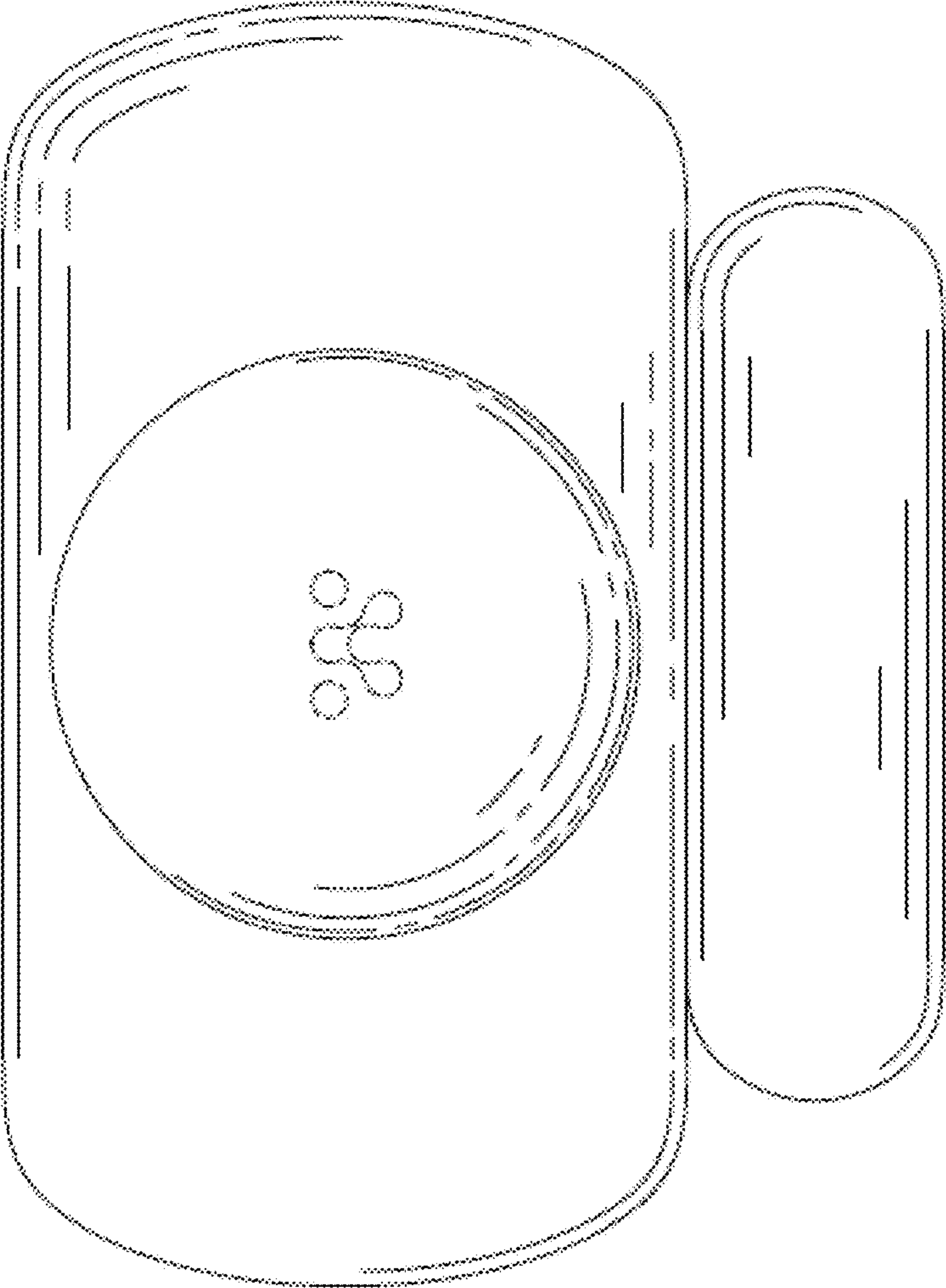

FIG. 2

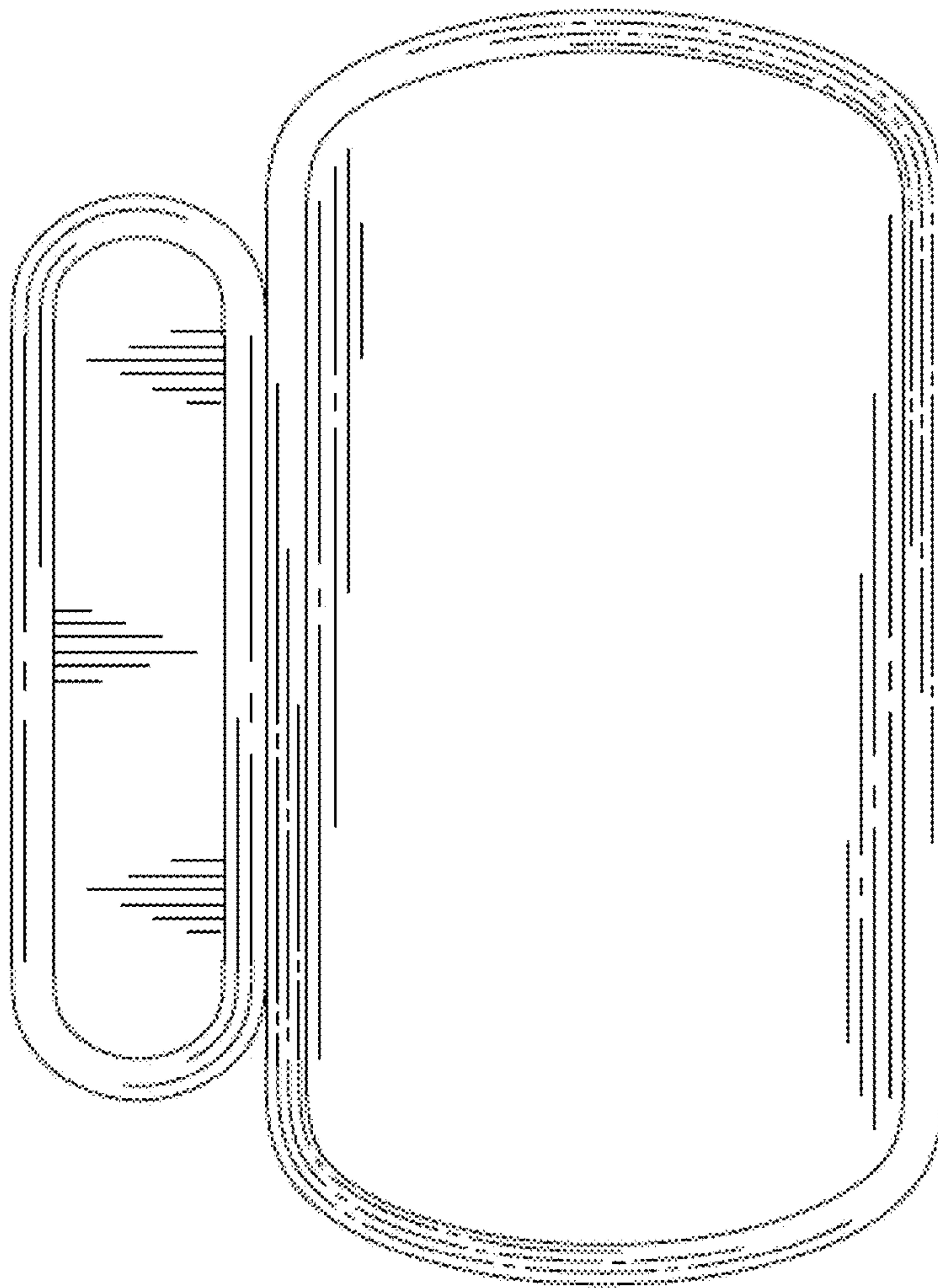

FIG. 3



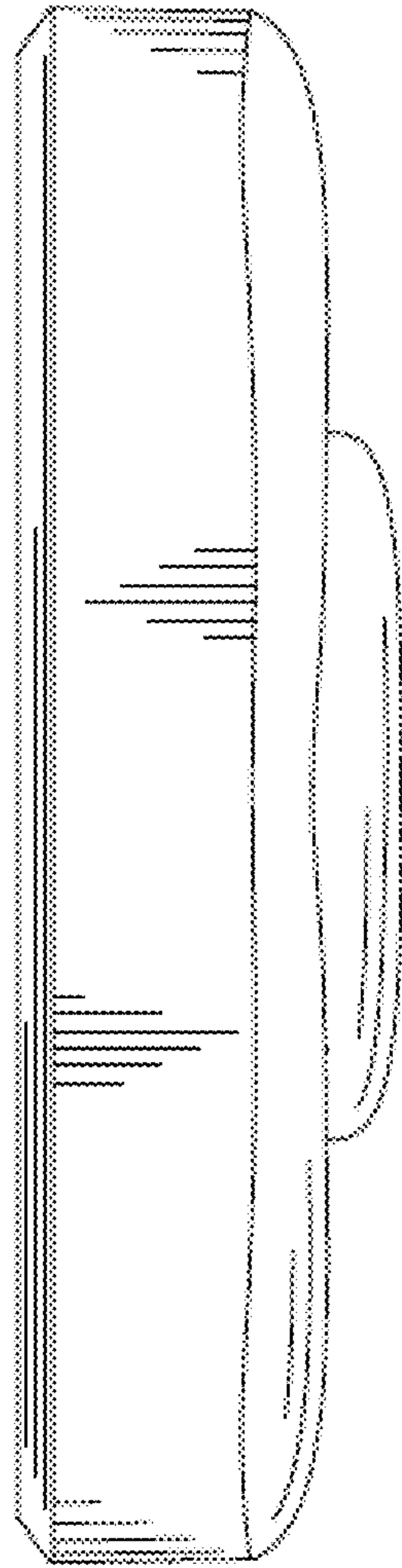

FIG. 4

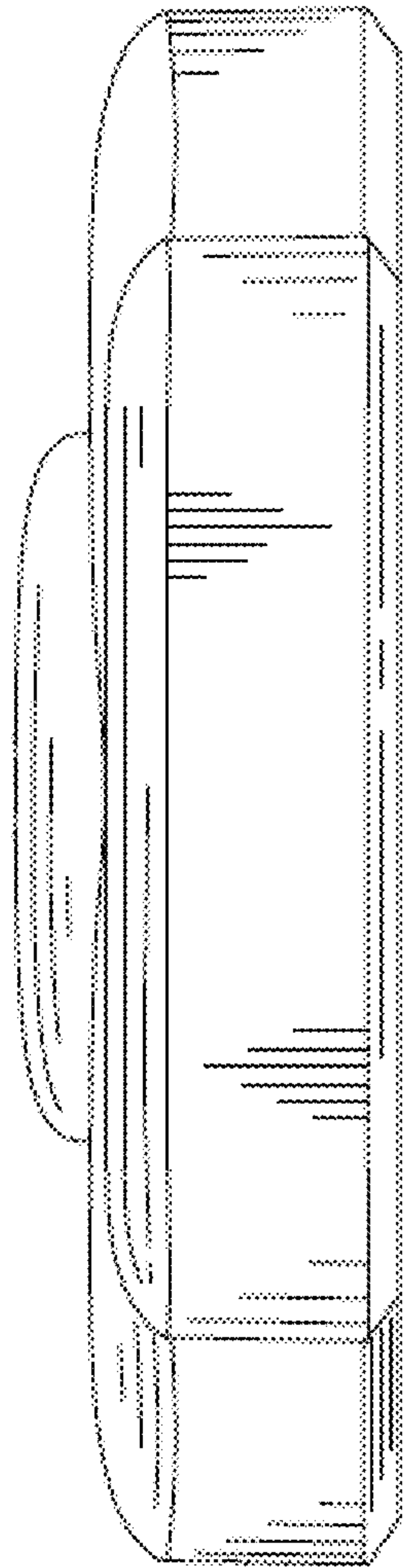

FIG. 5



FIG. 6



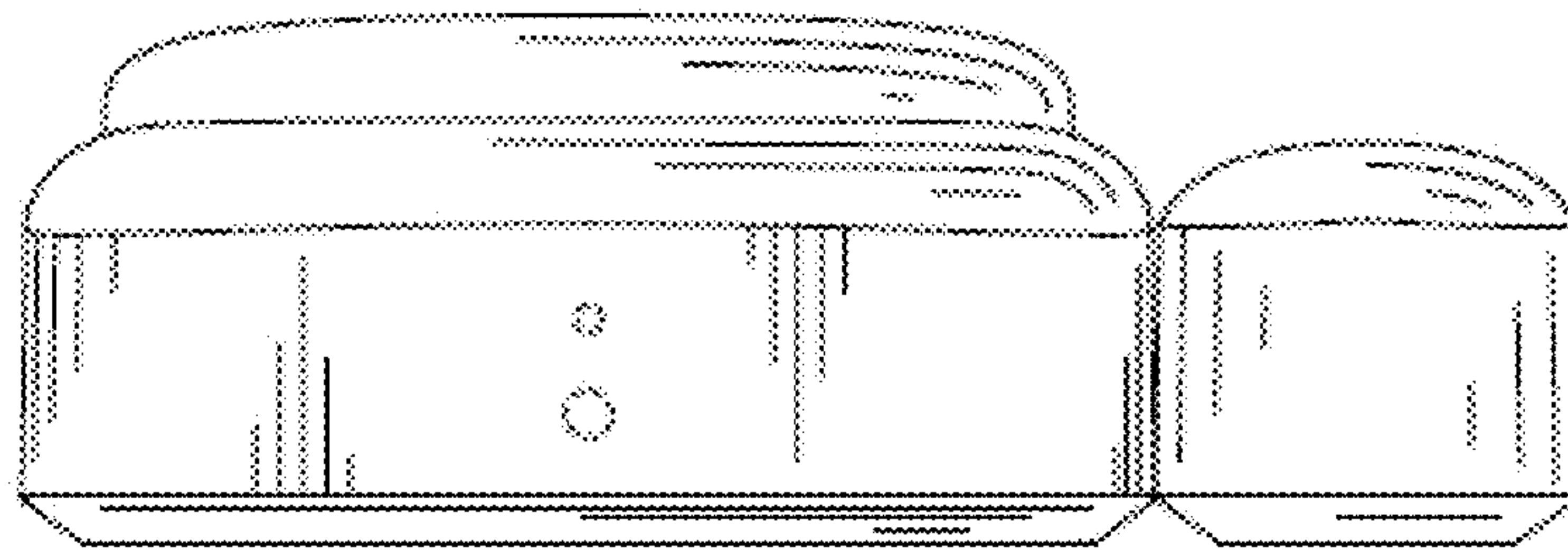

FIG. 7

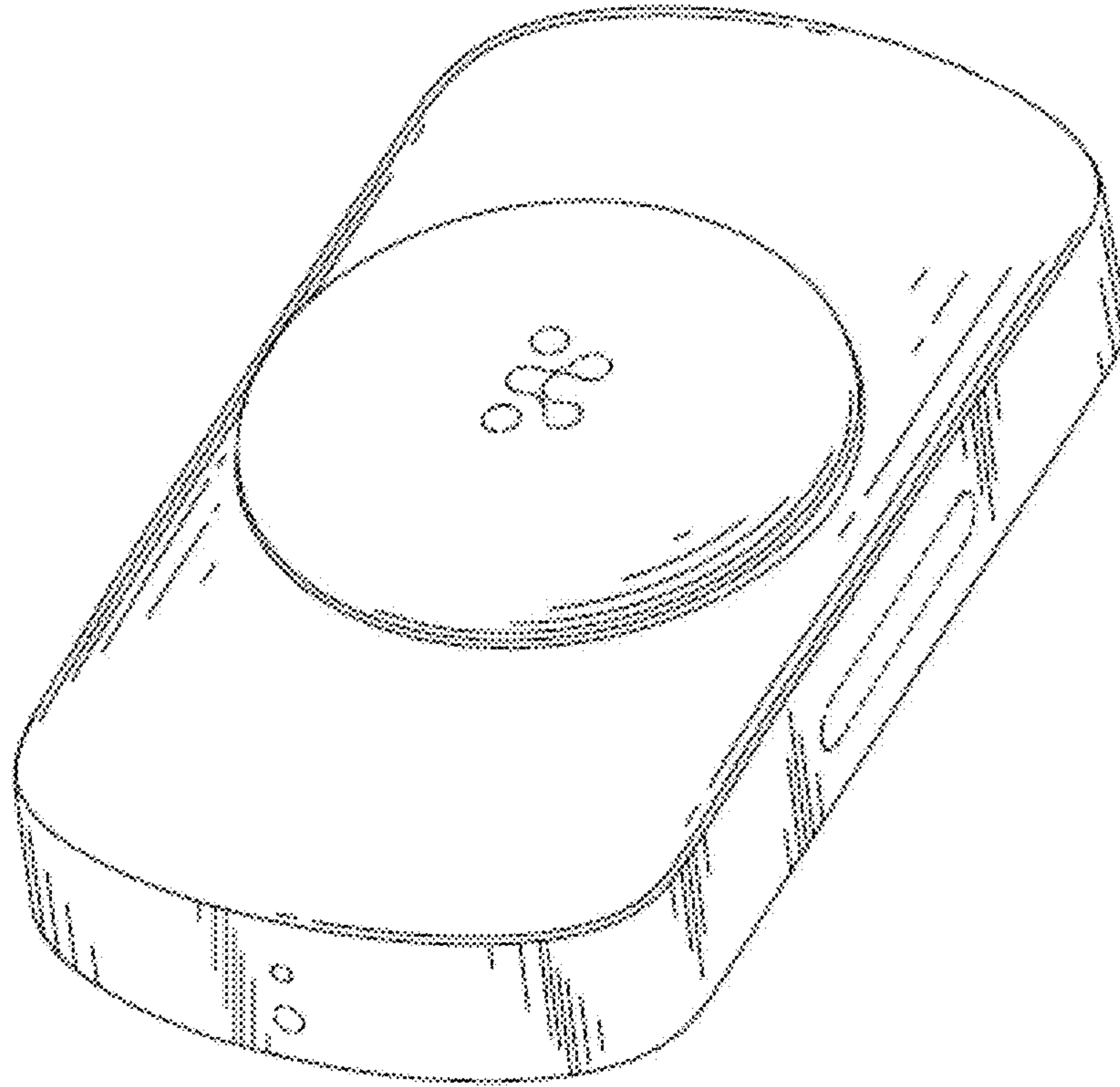

FIG. 8

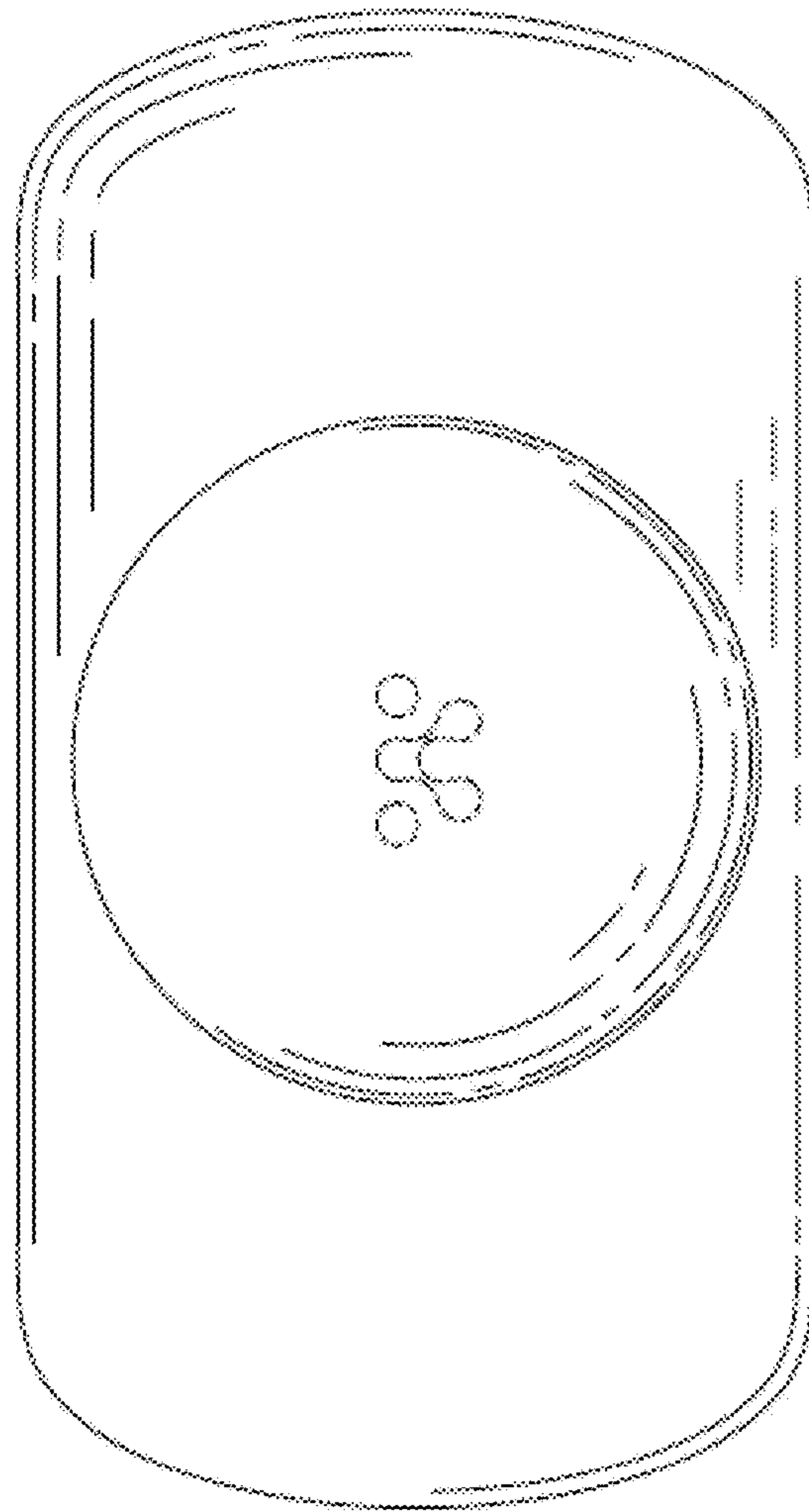

FIG. 9

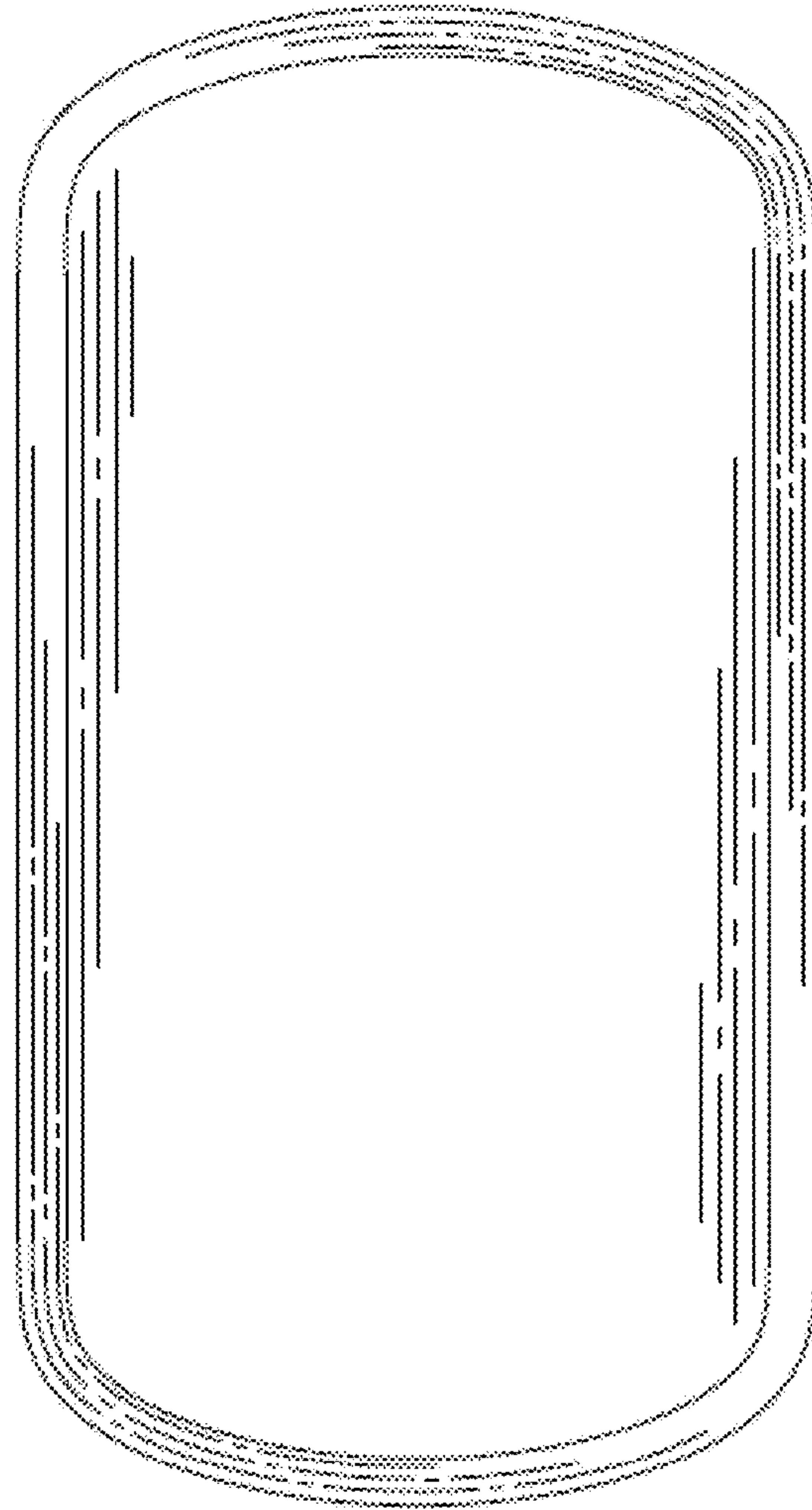

FIG. 10

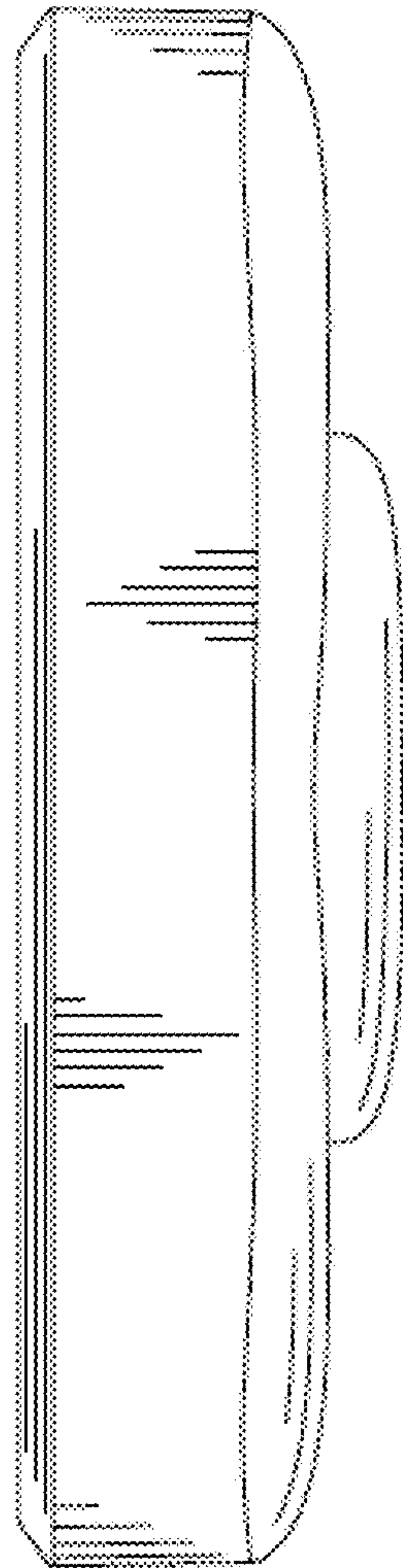

FIG. 11

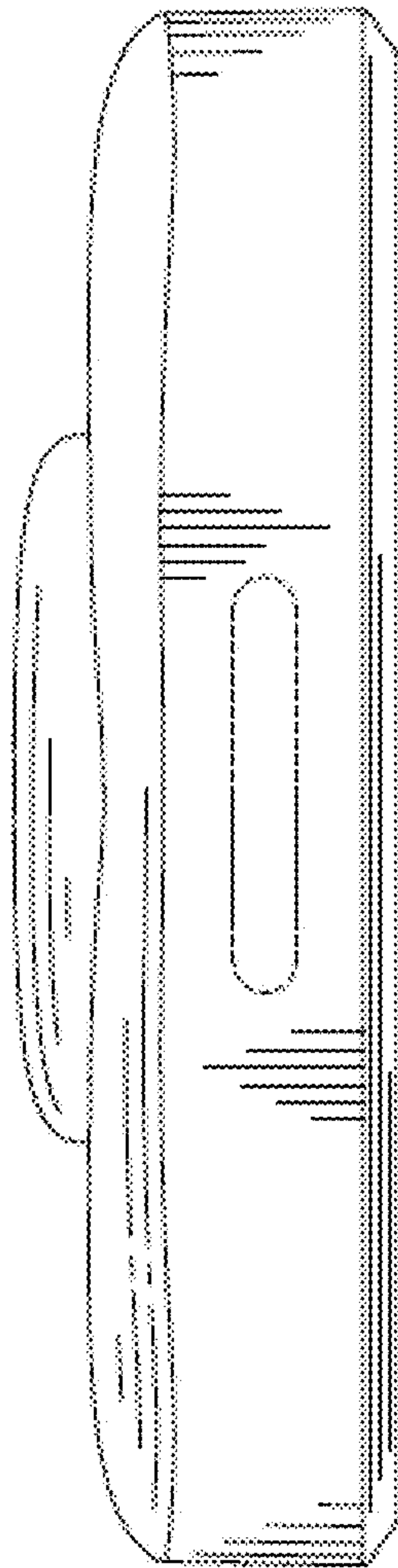

FIG. 12



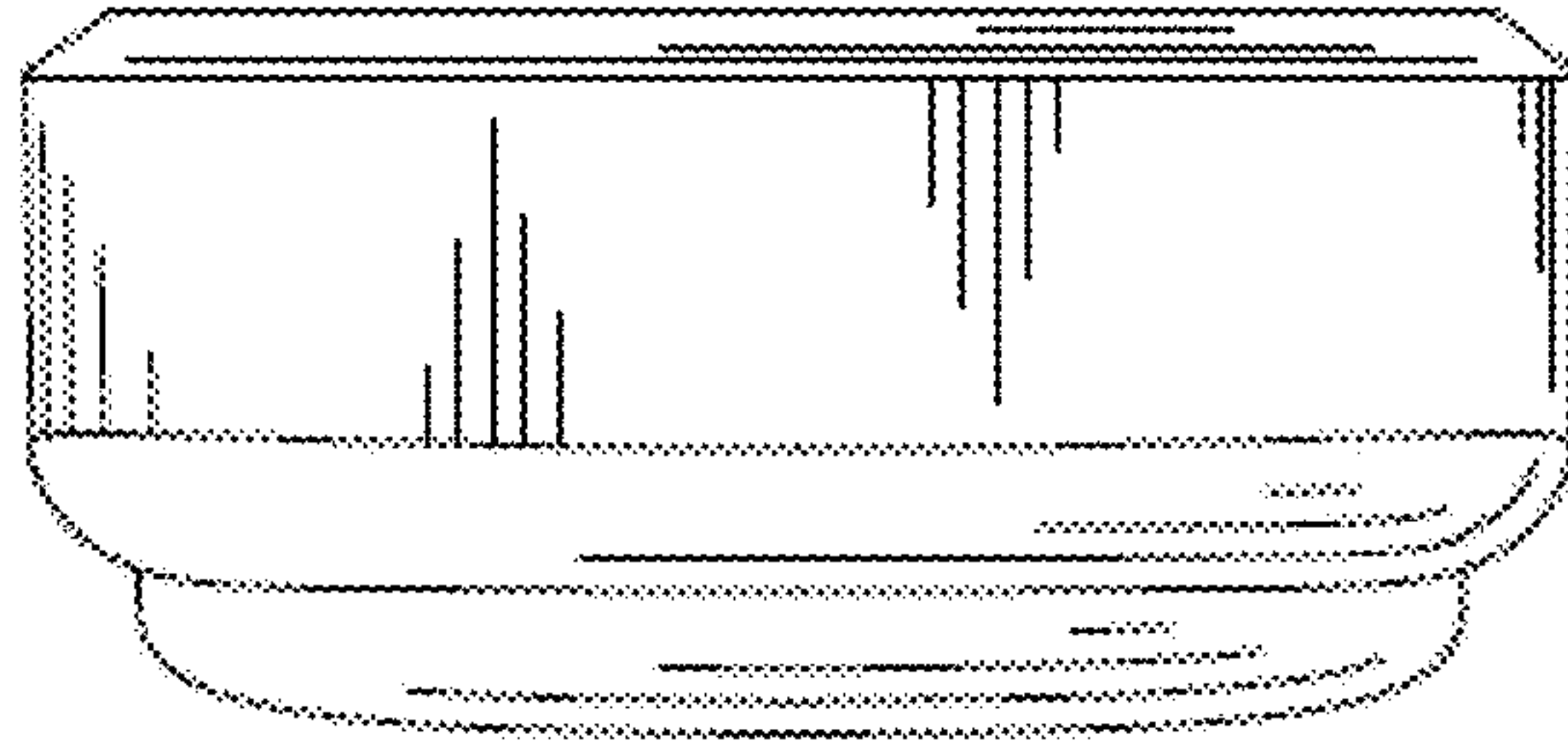

FIG. 13

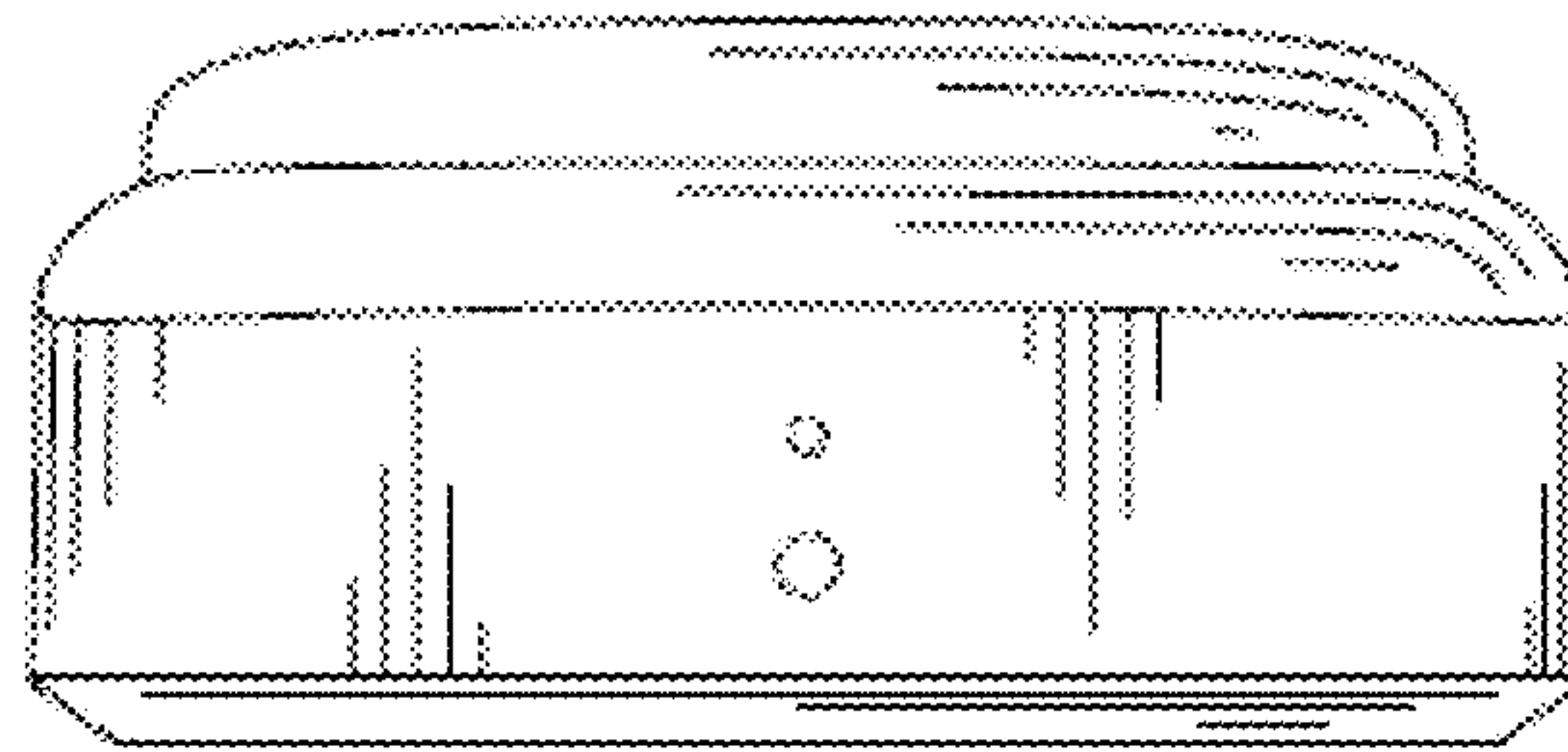

FIG. 14

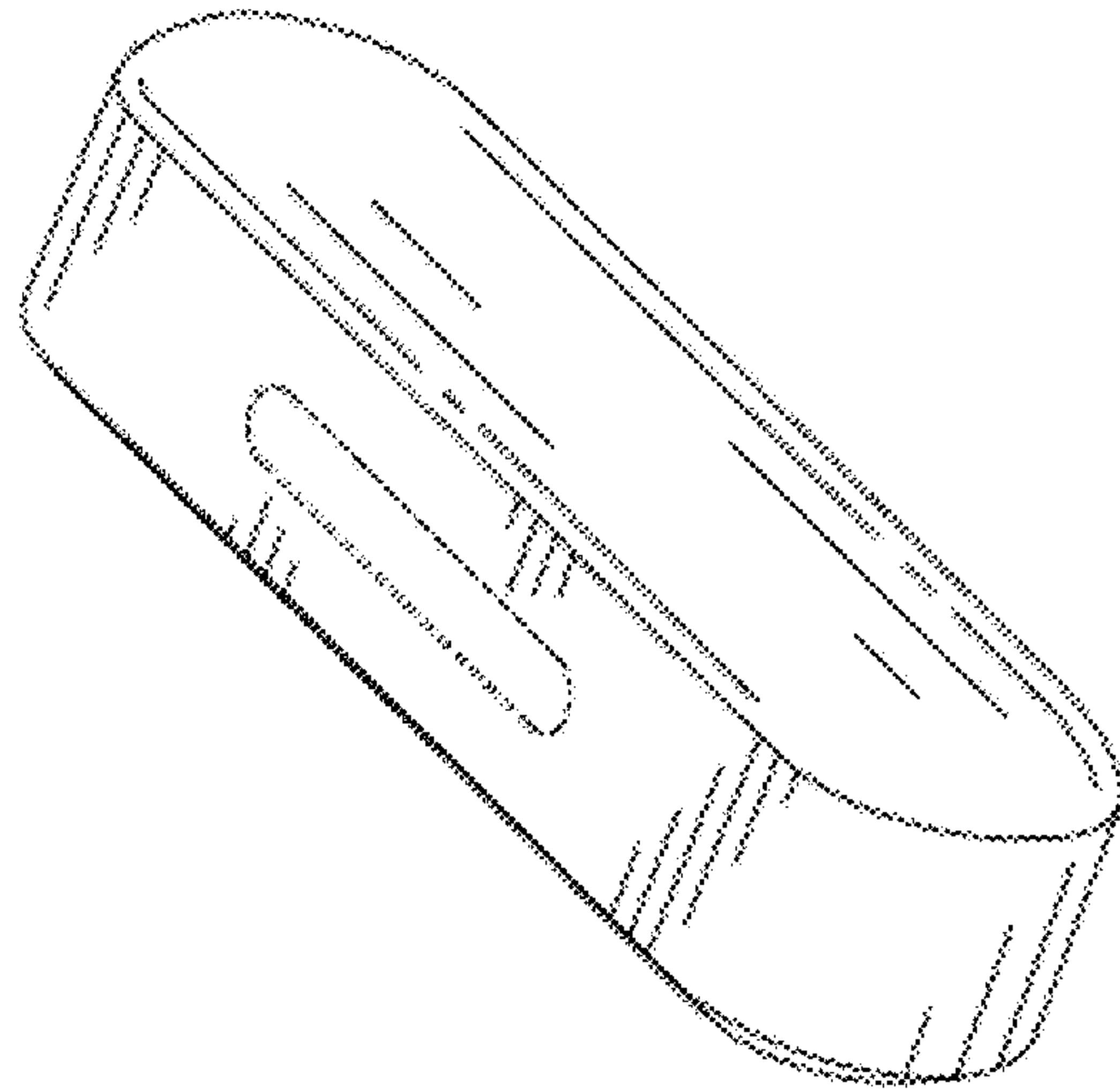

FIG. 15

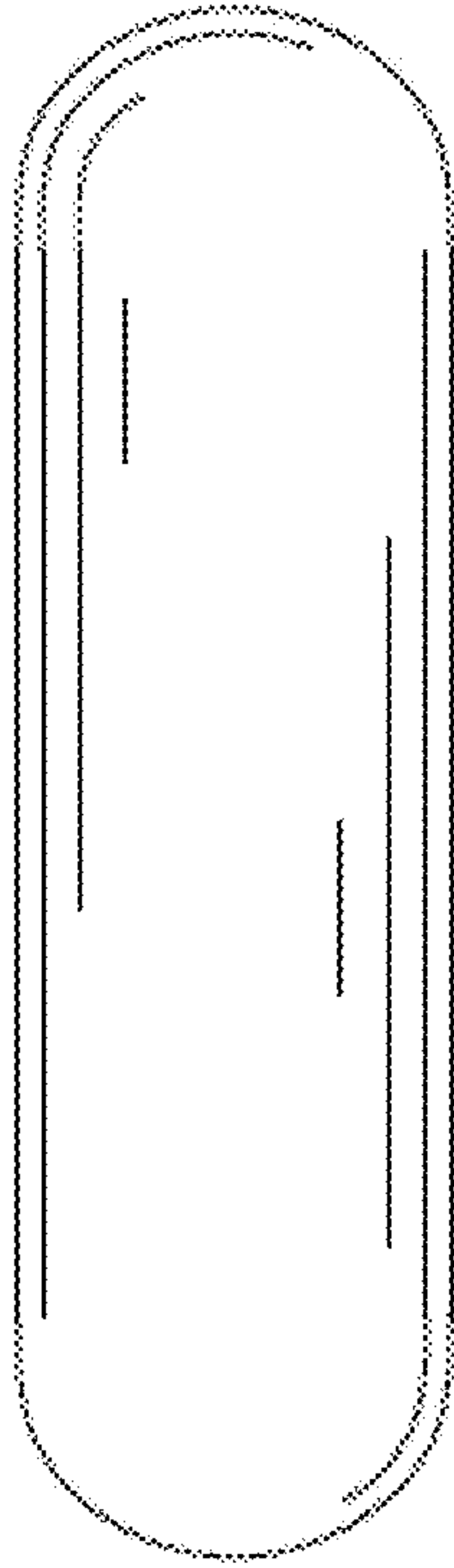

FIG. 16

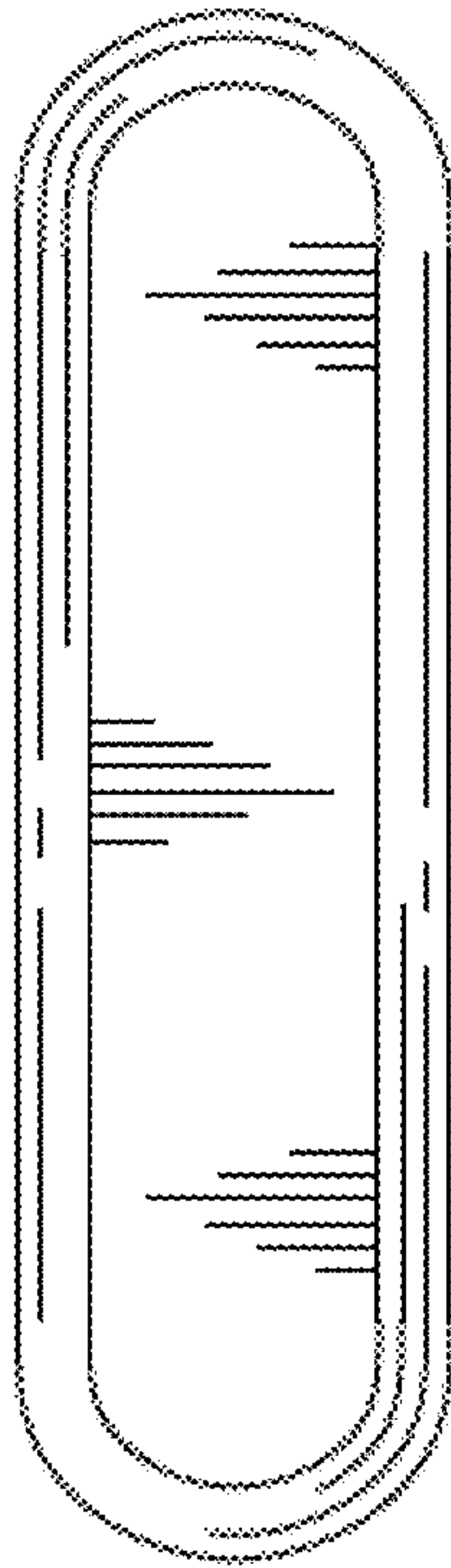

FIG. 17

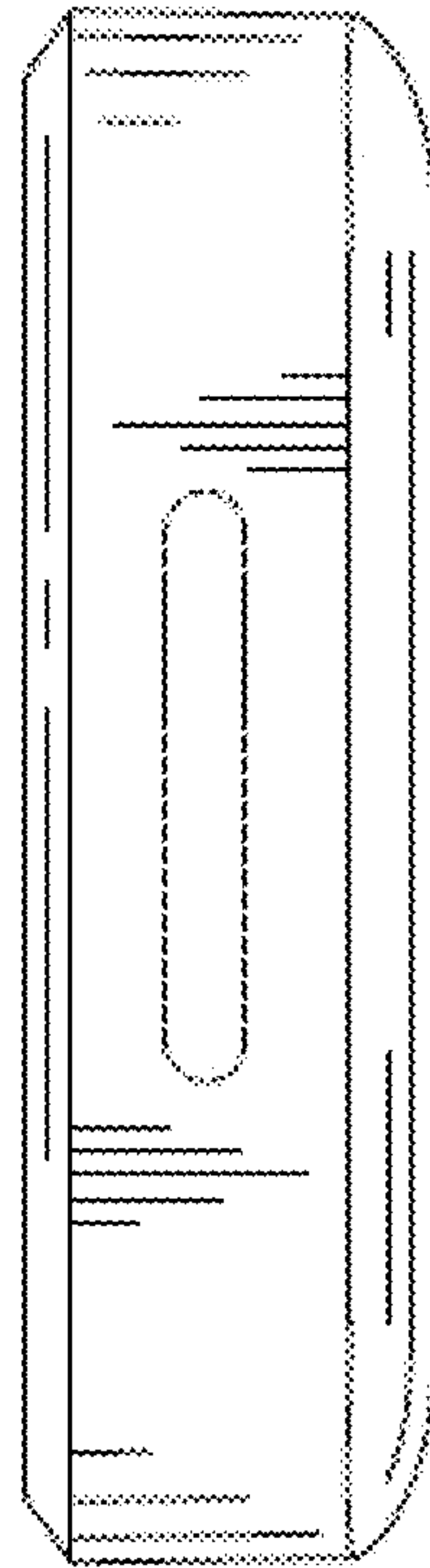

FIG. 18



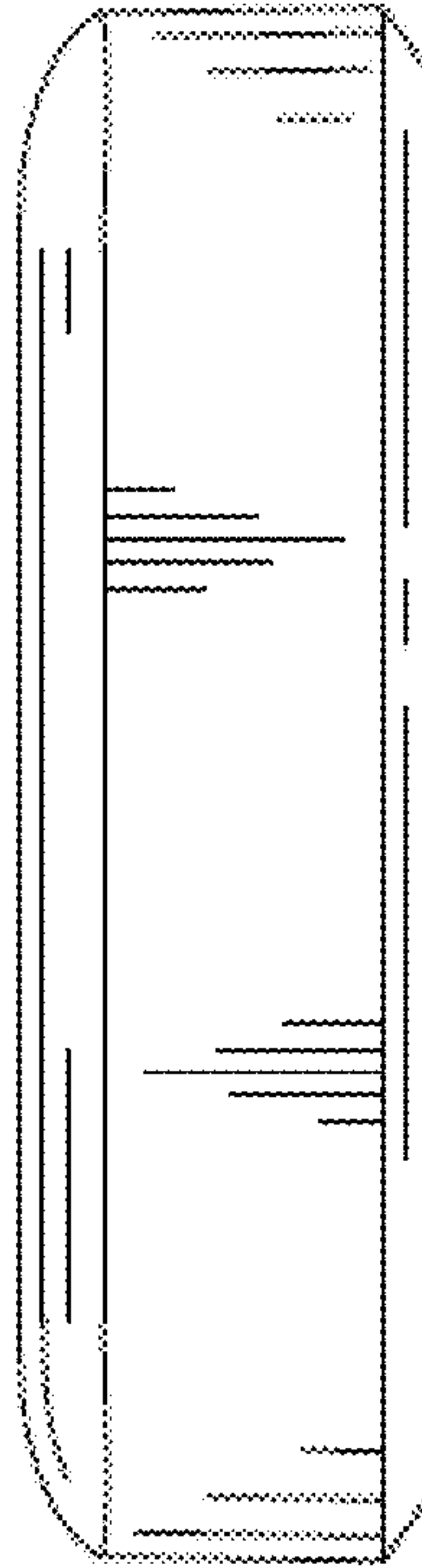

FIG. 19

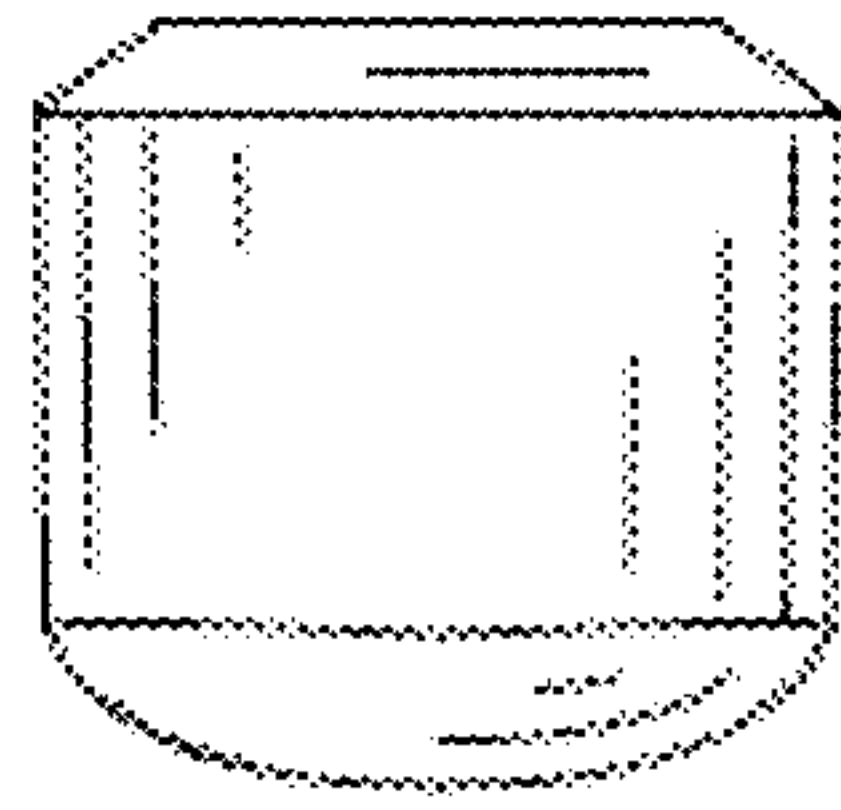

FIG. 20

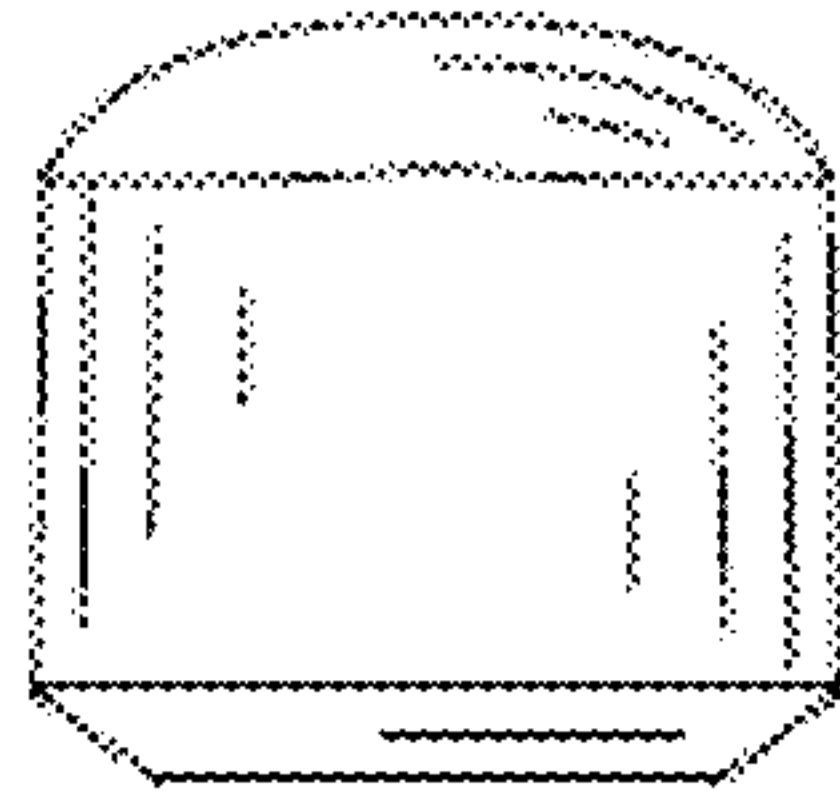

FIG. 21