



US00D787268S

(12) **United States Design Patent** (10) **Patent No.:** **US D787,268 S**
Matsuo (45) **Date of Patent:** **** May 23, 2017**

(54) **BEVERAGE BOTTLE**
(71) Applicant: **Thermos K.K.**, Niigata-ken (JP)
(72) Inventor: **Keita Matsuo**, Ichinomiya (JP)
(73) Assignee: **THERMOS K.K.** (JP)
(**) Term: **15 Years**

D590,661 S * 4/2009 Kitamura D7/510
D592,012 S * 5/2009 Carreno D7/510
D596,460 S * 7/2009 Nezu D7/510
D619,418 S * 7/2010 Nezu D7/510
RE42,484 E * 6/2011 Kitamura D7/510
D655,580 S * 3/2012 Kotani D7/608
D695,069 S * 12/2013 Lane D7/510
D710,653 S * 8/2014 Goto D7/608
D725,966 S * 4/2015 Boroski D7/511
D744,290 S * 12/2015 Endo D7/608
2015/0282654 A1 * 10/2015 Kurabe A47G 19/2272
220/254.5

(21) Appl. No.: **29/545,875**

(22) Filed: **Nov. 17, 2015**

(30) **Foreign Application Priority Data**

May 26, 2015 (JP) 2015-011594

(51) **LOC (10) Cl.** **07-01**

(52) **U.S. Cl.**
USPC **D7/510**

(58) **Field of Classification Search**
USPC D7/509, 510, 511, 523, 538, 543;
220/200, 705-710, 592.16, 592.17;
215/396-400; D23/209; 210/203, 205,
210/206

CPC A47G 19/22; A47G 19/2205; A47G 19/2211;
A47G 19/2216; A47G 19/2272; A47G
19/2288; A45F 3/16; A47J 43/27; B65D
41/04; B65D 41/56; B65D 43/0247

See application file for complete search history.

(56) **References Cited**

U.S. PATENT DOCUMENTS

D485,132 S * 1/2004 Ohno D7/608
D512,875 S * 12/2005 Maldonado D7/510
D588,411 S * 3/2009 Watanabe D7/507

* cited by examiner

Primary Examiner — Cynthia Ramirez

Assistant Examiner — Andrew Kerr

(74) *Attorney, Agent, or Firm* — Polsinelli PC

(57) **CLAIM**

The ornamental design for a beverage bottle, as shown and described.

DESCRIPTION

FIG. 1 is a perspective view of a beverage bottle showing my new design;

FIG. 2 is a front elevation view thereof;

FIG. 3 is a rear elevation view thereof;

FIG. 4 is a left side elevation view thereof;

FIG. 5 is a right side elevation view thereof;

FIG. 6 is a top plan view thereof;

FIG. 7 is a bottom plan view thereof; and,

FIG. 8 is a perspective view thereof, in use condition.

The broken lines in the figures are included for the purpose of illustrating unclaimed environment and form no part of the claimed design.

1 Claim, 8 Drawing Sheets

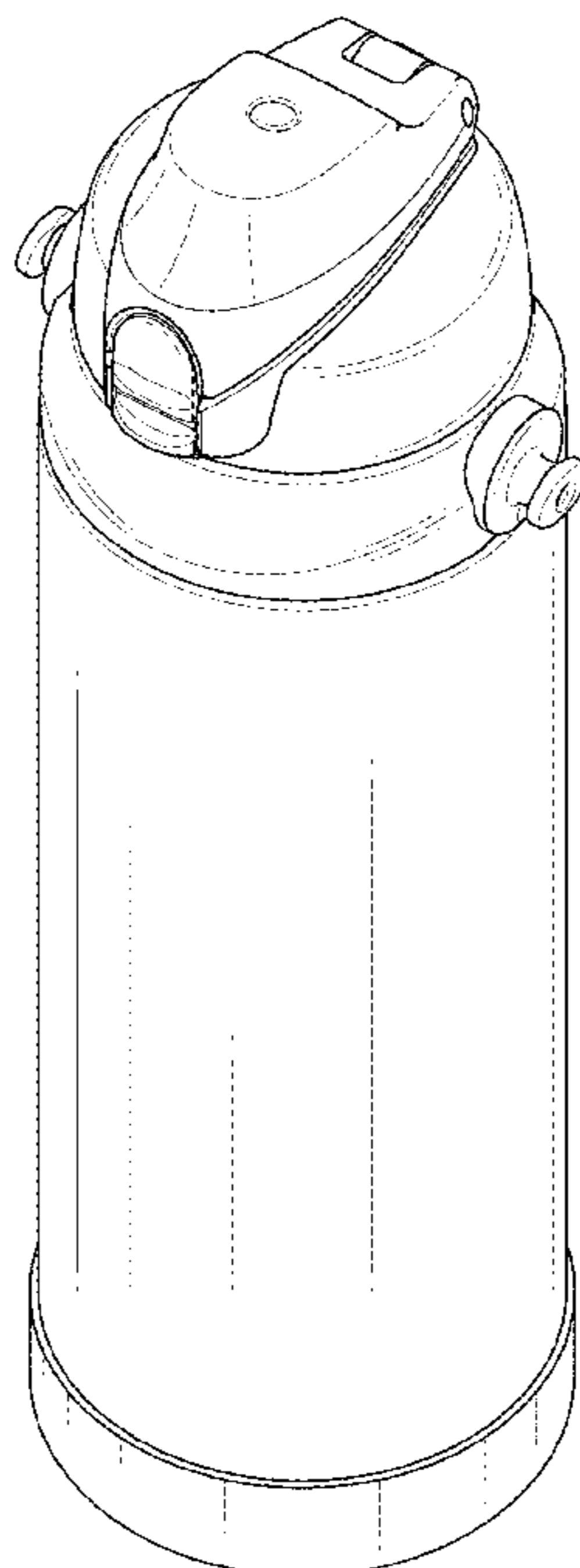

FIG. 1

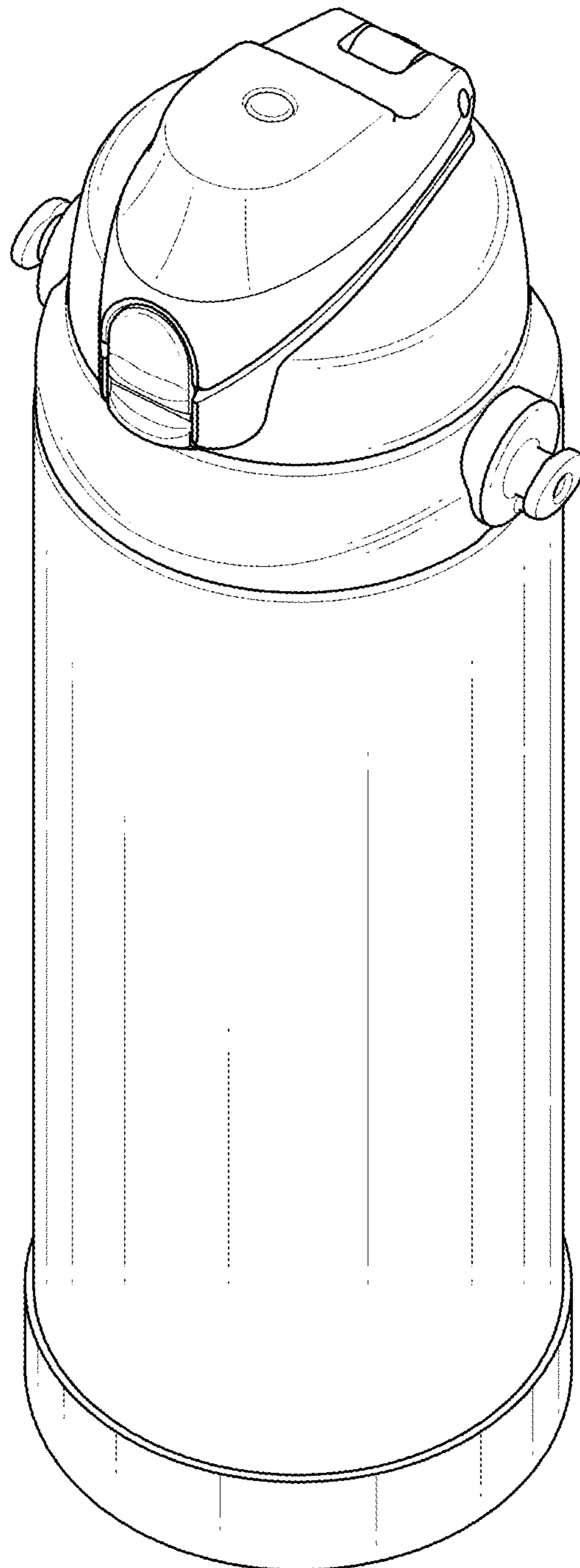

FIG. 2

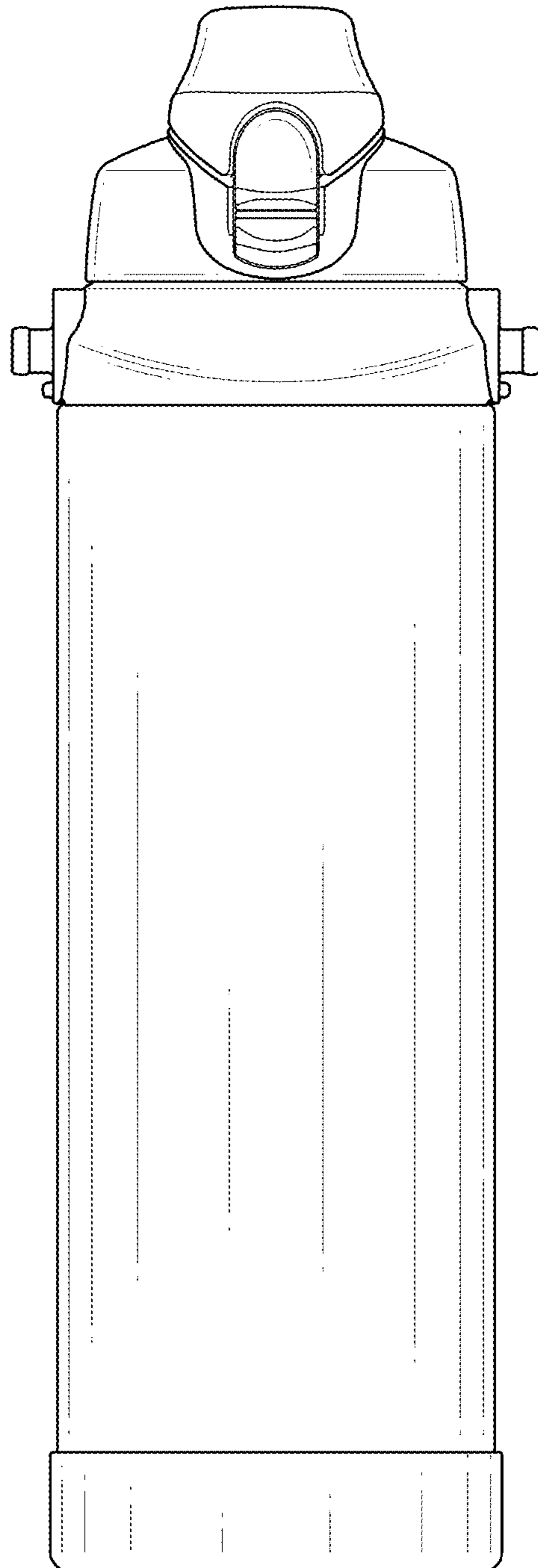

FIG. 3

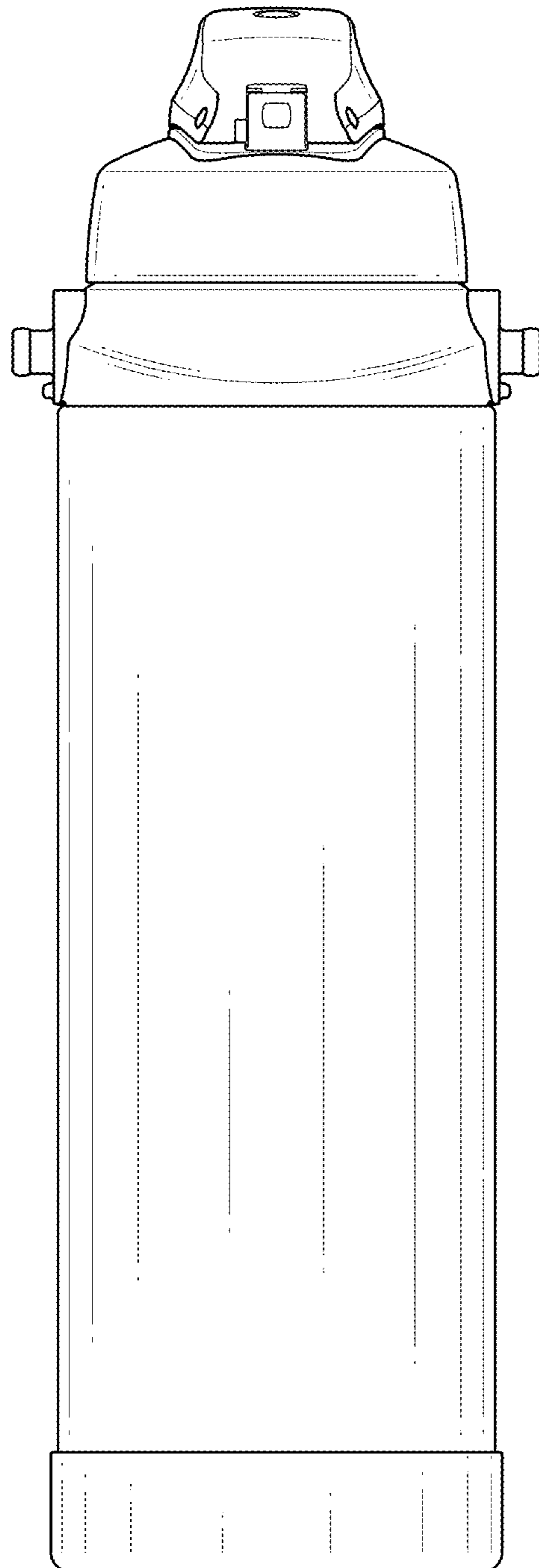

FIG. 4

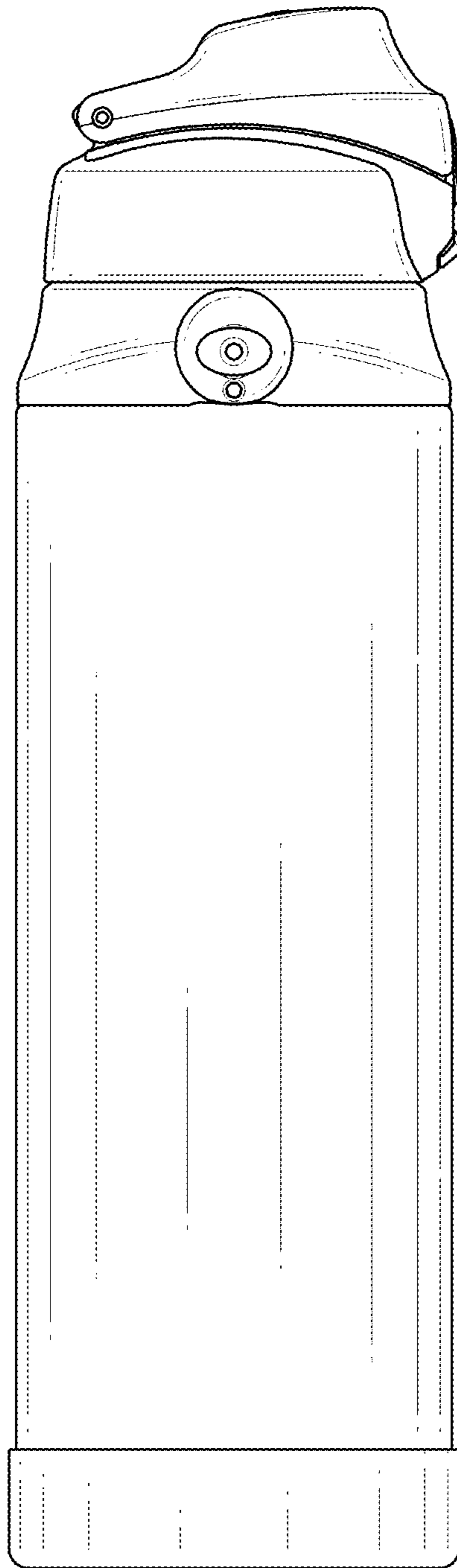

FIG. 5

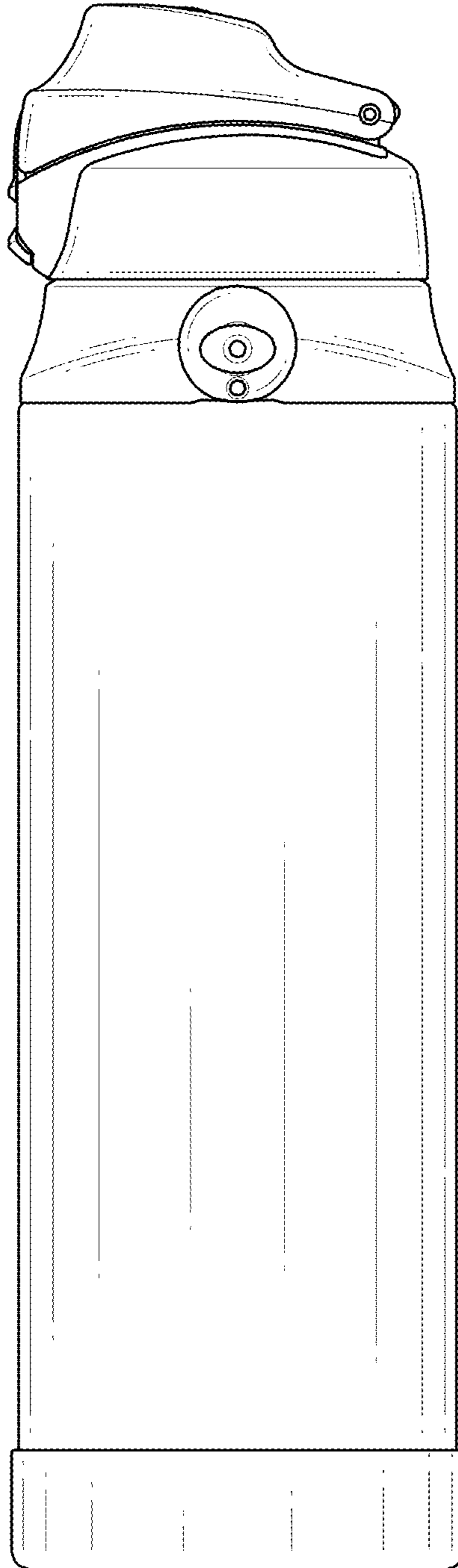

FIG. 6

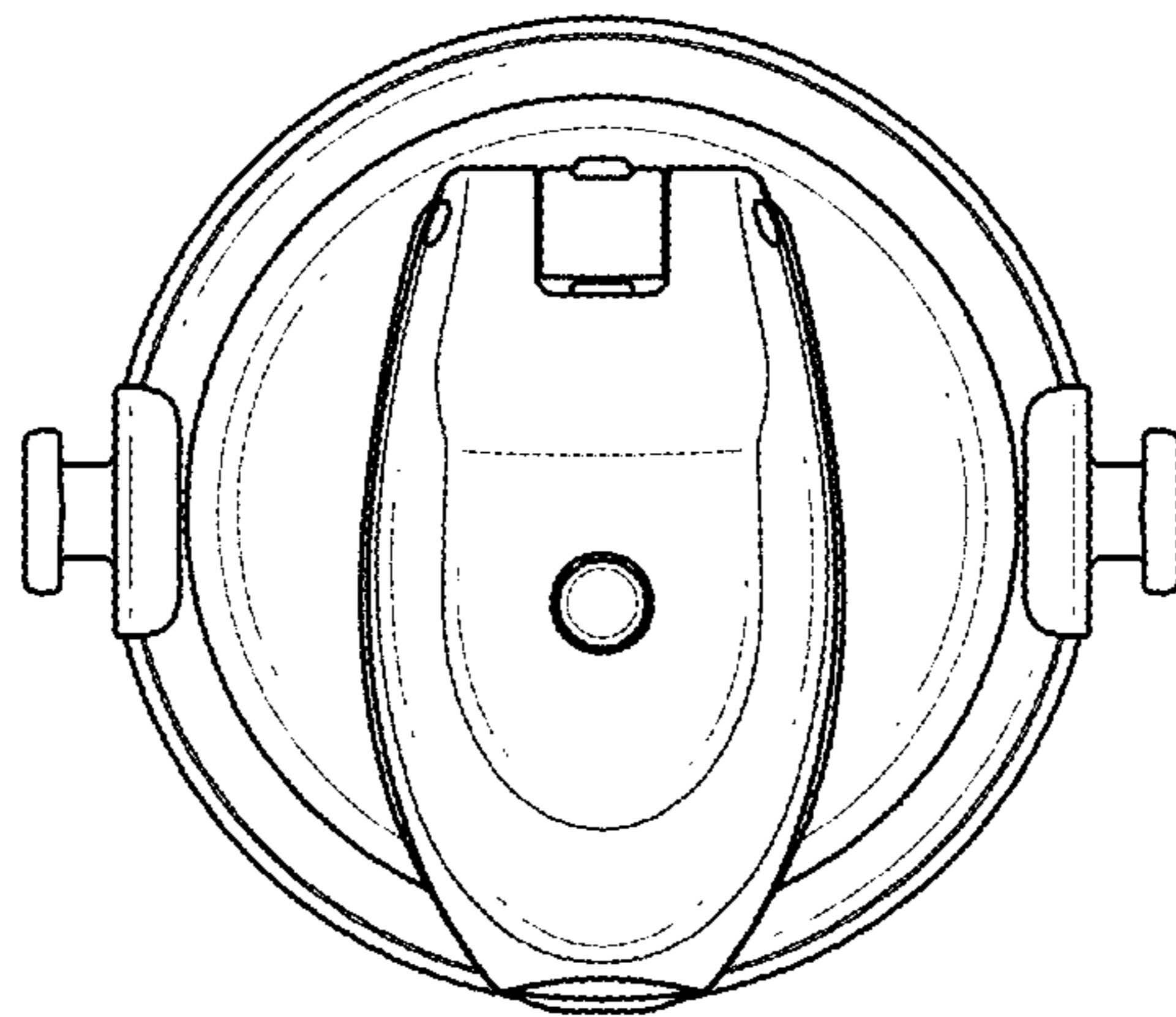

FIG. 7

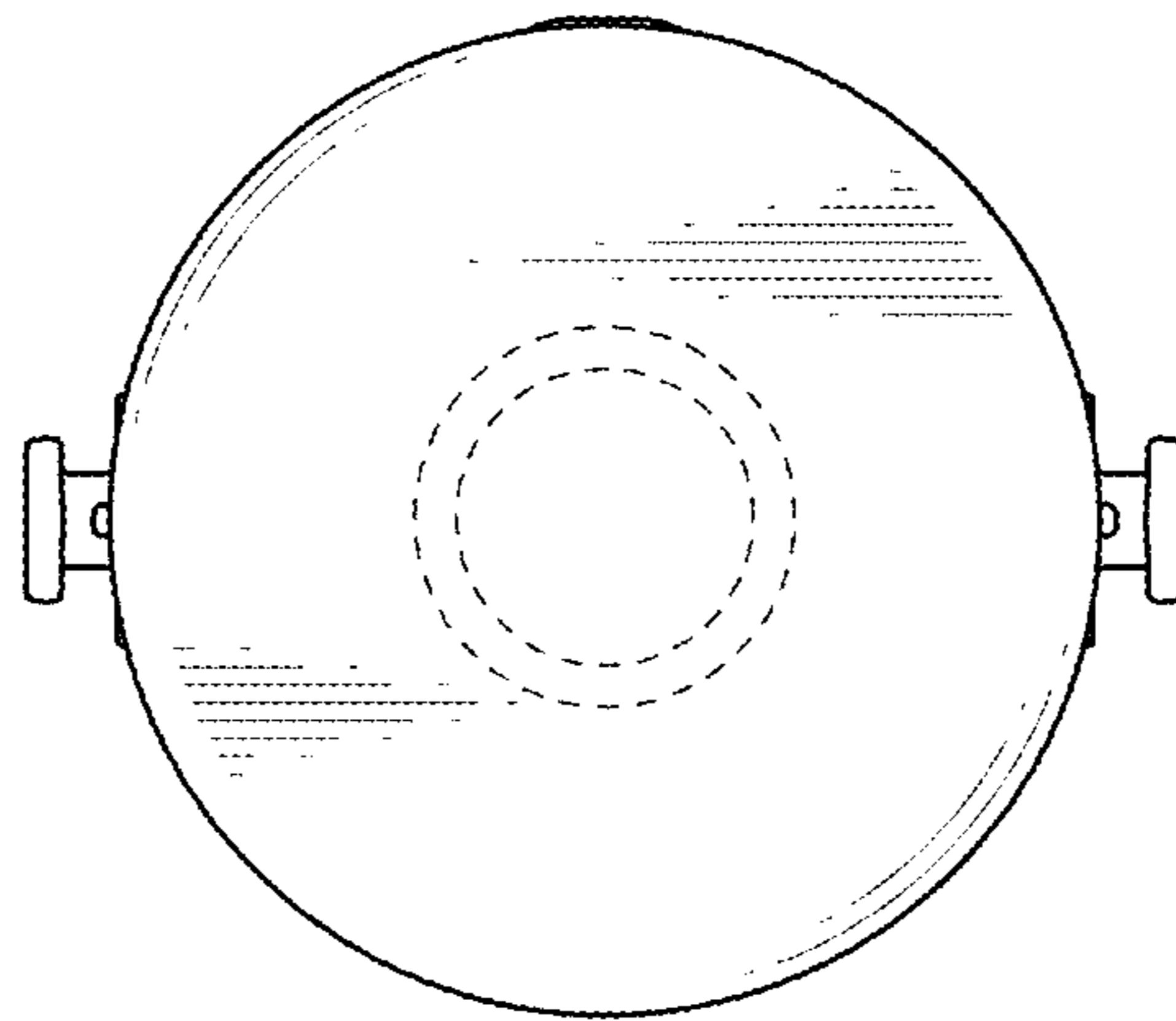

FIG. 8

