



US00D787175S

(12) **United States Design Patent** (10) **Patent No.:** **US D787,175 S**
Winters Giesting et al. (45) **Date of Patent:** **** May 23, 2017**

- (54) **WINE CARRIER**
- (71) Applicant: **The Gem Group, Inc.**, Lawrence, MA (US)
- (72) Inventors: **Meredith Winters Giesting**, Brookline, MA (US); **Danea Marie Barilaro**, Jamaica Plain, MA (US)
- (73) Assignee: **The Gem Group Inc.**, Lawrence, MA (US)
- (**) Term: **15 Years**
- (21) Appl. No.: **29/527,868**
- (22) Filed: **May 22, 2015**
- (51) **LOC (10) Cl.** **03-01**
- (52) **U.S. Cl.**
USPC **D3/202**
- (58) **Field of Classification Search**
USPC D3/201, 202, 229, 224, 226, 231, 233, D3/269, 300, 315; D9/455, 706, 707, D9/711, 751, 756; D7/605, 607, 624.2
CPC .. B56D 2571/0066; B56D 2571/00716; B56D 2571/00141; B56D 77/24; B56D 81/3876; B56D 23/102; A45C 11/20
See application file for complete search history.

- (56) **References Cited**
U.S. PATENT DOCUMENTS
- 1,808,375 A * 6/1931 Plooster A45C 3/04 383/121
- 4,428,484 A * 1/1984 Rattay B65D 31/12 206/548
- 4,696,403 A * 9/1987 Hoover B29C 65/028 206/428
- D344,413 S * 2/1994 Bedrosian D3/202
- 5,680,958 A * 10/1997 Mann A45F 3/14 220/739
- D404,911 S * 2/1999 Sims D3/229

- D408,137 S * 4/1999 Leininger D3/201
- D409,450 S * 5/1999 Hamilton D7/607
- D414,332 S * 9/1999 Brechard D3/201
- D433,802 S * 11/2000 Graham D3/229
- D517,797 S * 3/2006 Lown D3/202
- D517,798 S * 3/2006 Lown D3/202
- D518,631 S * 4/2006 Lown D3/202
- D520,229 S * 5/2006 Lown D3/202
- D525,776 S * 8/2006 Lown D3/202
- D529,278 S * 10/2006 Swartz D3/202
- D529,709 S * 10/2006 Swartz D3/202
- D543,022 S * 5/2007 Alon D3/218
- 7,219,814 B2 * 5/2007 Lown B65D 23/08 206/427
- D549,445 S * 8/2007 Lown D3/202
- D549,446 S * 8/2007 Lown D3/202
- D552,342 S * 10/2007 Kao D3/202
- D555,352 S * 11/2007 Lown D3/202
- D560,351 S * 1/2008 Boehm D3/201

(Continued)

Primary Examiner — John Windmuller
Assistant Examiner — Steven Czyz
(74) *Attorney, Agent, or Firm* — Loginov & Associates, PLLC; William A. Loginov

(57) **CLAIM**

The ornamental design for a wine carrier, as shown and described.

DESCRIPTION

FIG. 1 is a perspective view of a wine carrier;
FIG. 2 is a front view of the wine carrier;
FIG. 3 is a rear view of the wine carrier;
FIG. 4 is a right side view of the wine carrier;
FIG. 5 is a left side view of the wine carrier;
FIG. 6 is a top view of the wine carrier; and,
FIG. 7 is a bottom view of the wine carrier.
The broken line elements in all views are for illustrative and environmental purposes only and form no part of the claimed design.

1 Claim, 3 Drawing Sheets

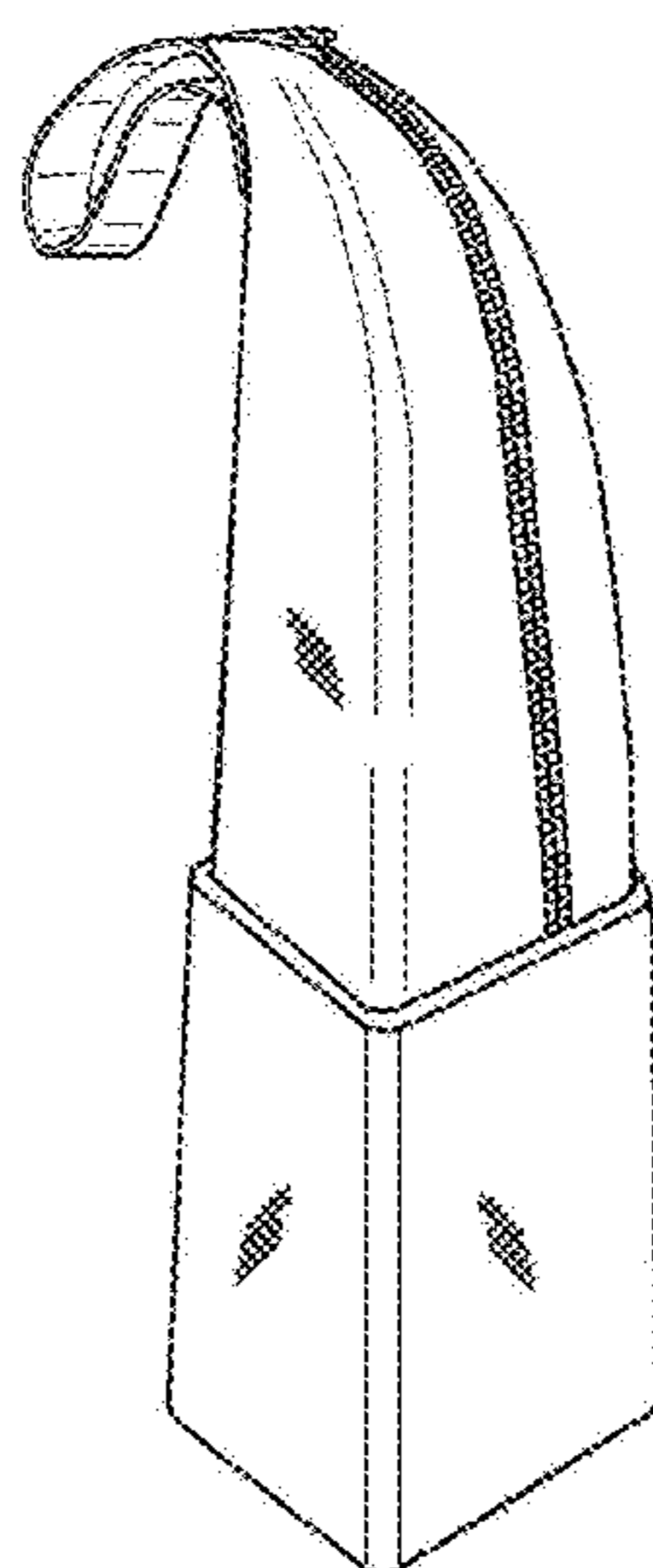

(56)

References Cited

U.S. PATENT DOCUMENTS

D564,215	S *	3/2008	Swartz	D3/202
D564,216	S *	3/2008	Thai	D3/202
D571,103	S *	6/2008	Simonian	D3/201
7,467,729	B2	12/2008	Lown et al.		
D587,004	S *	2/2009	Lown	D3/202
D587,897	S *	3/2009	Radke	D3/202
D594,648	S *	6/2009	Lown	D3/202
D596,840	S *	7/2009	Lown	D3/202
D597,298	S *	8/2009	Lown	D3/202
D597,299	S *	8/2009	Lown	D3/202
D609,454	S *	2/2010	Porter-Young	D3/202
D622,954	S *	9/2010	Porter-Young	D3/202
D648,520	S *	11/2011	Fahrendorff	D3/201
D650,985	S *	12/2011	Swartz	D3/202
D674,185	S *	1/2013	Kao	D3/229
D679,551	S *	4/2013	Denzinger	D7/607
D680,386	S *	4/2013	Butters	D7/607
D691,790	S *	10/2013	Denzinger	D3/202
D714,555	S *	10/2014	Feder	D3/202
D731,168	S *	6/2015	Cascio	D3/201
D733,609	S *	7/2015	Sade	D11/152
D748,479	S *	2/2016	Barkerding	D9/455
2003/0228072	A1 *	12/2003	Tyberg	A45C 7/0077 383/2
2007/0071366	A1 *	3/2007	Kao	B65D 81/3879 383/38
2008/0083629	A1 *	4/2008	Soucie	A45C 3/04 206/170
2009/0038972	A1 *	2/2009	Lown	B65D 23/08 206/427

* cited by examiner

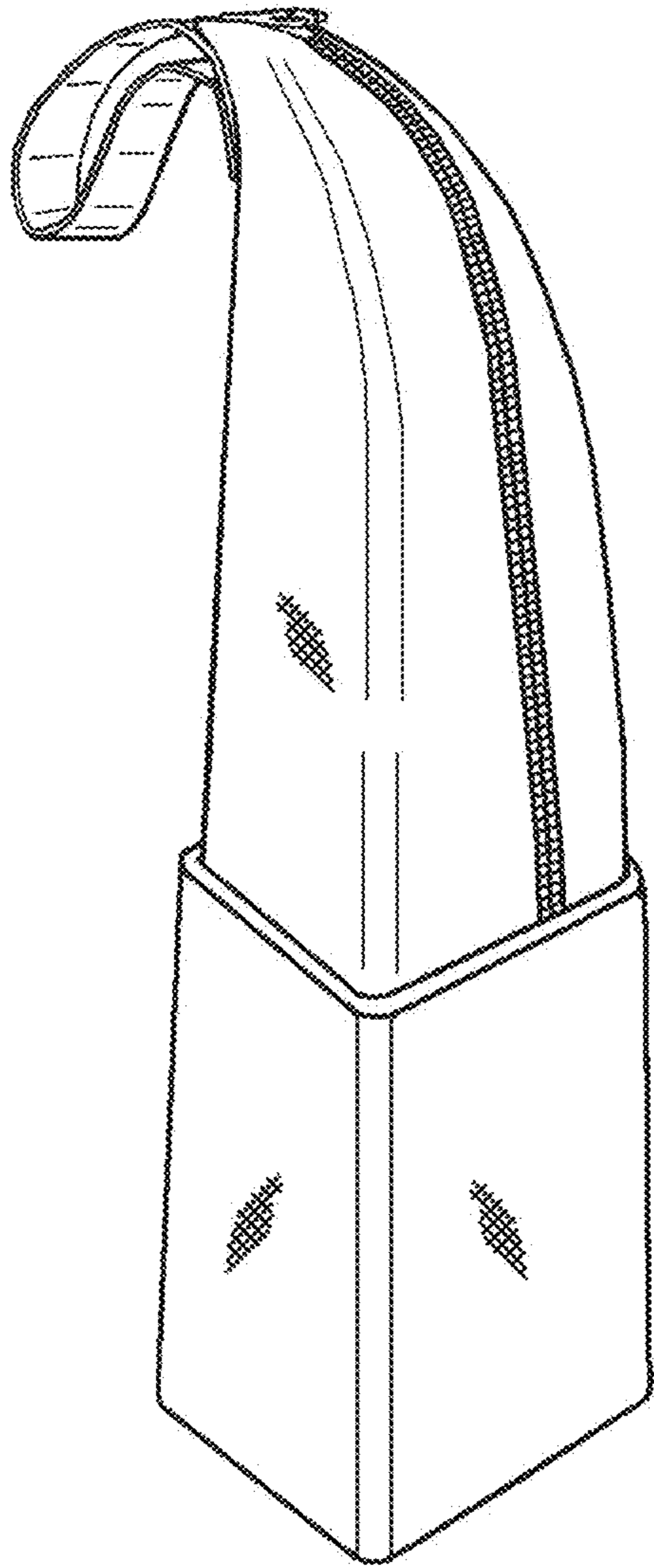

Fig. 1

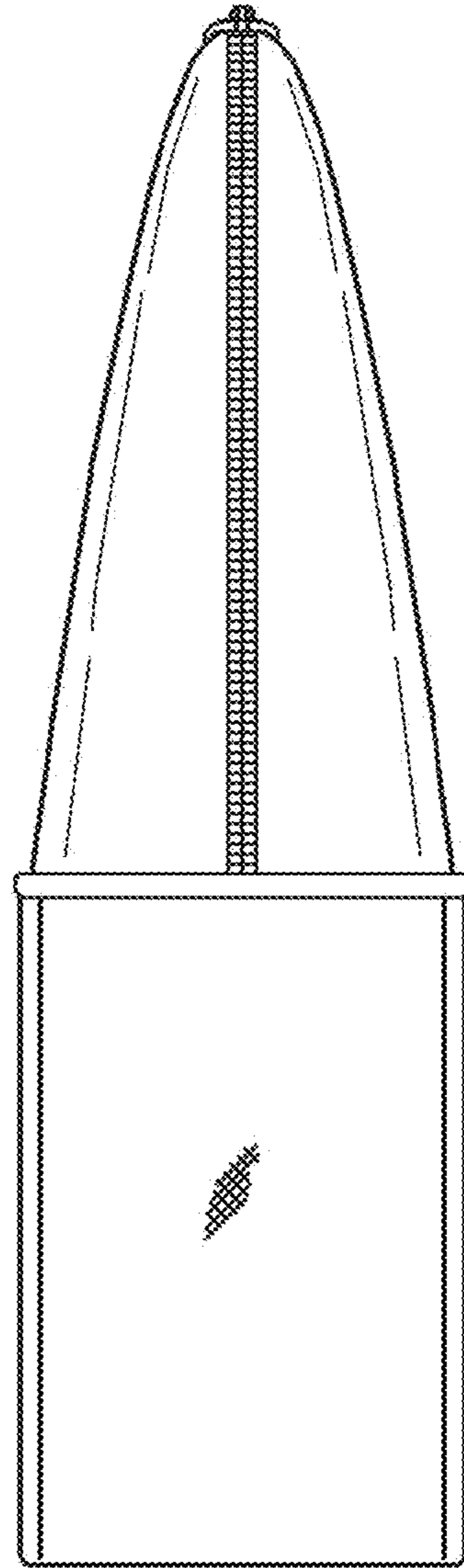

Fig. 2

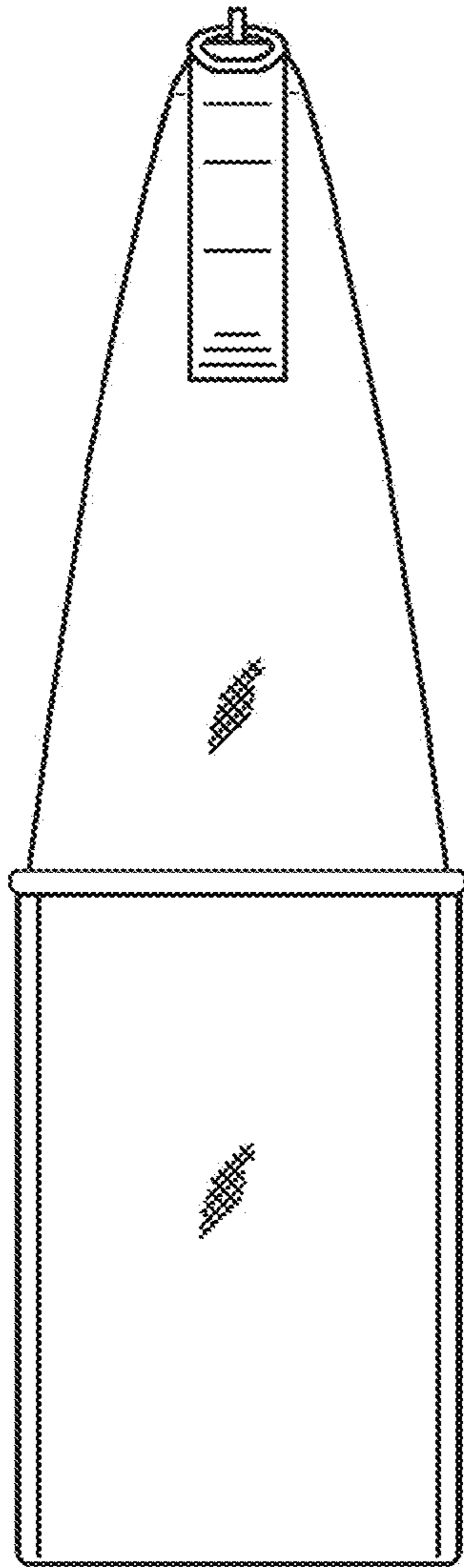

Fig. 3

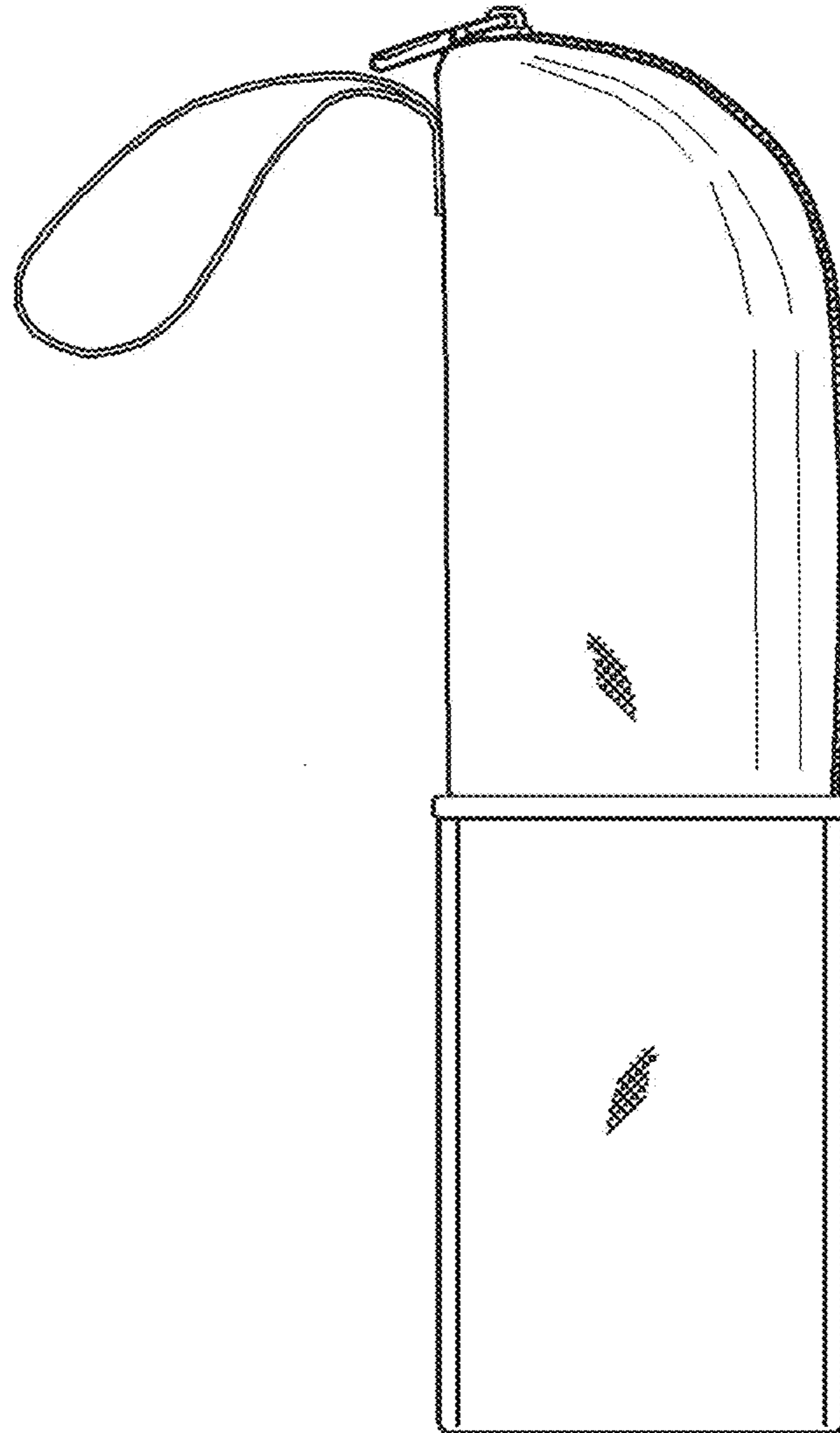

Fig. 4

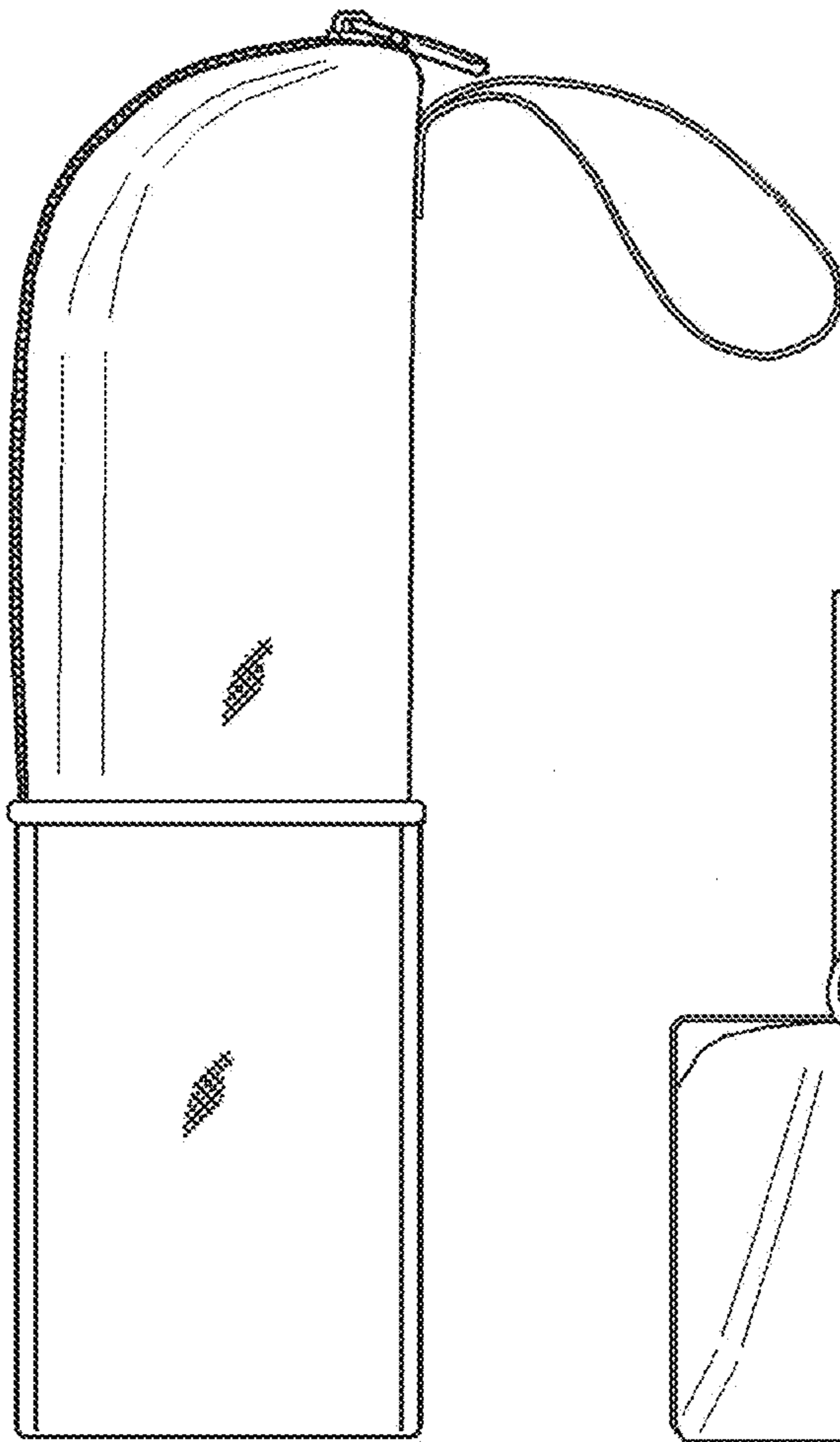

Fig. 5

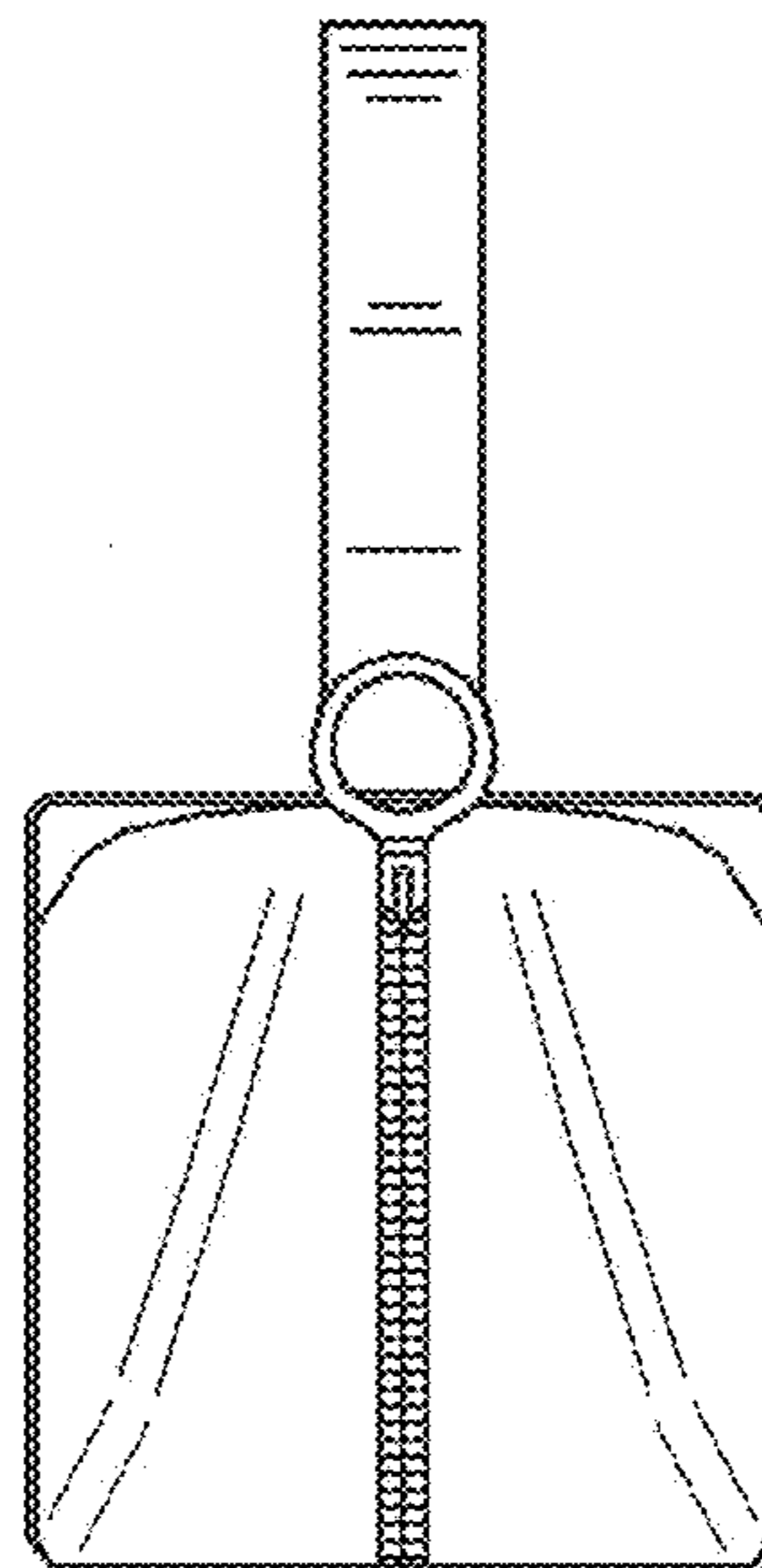

Fig. 6

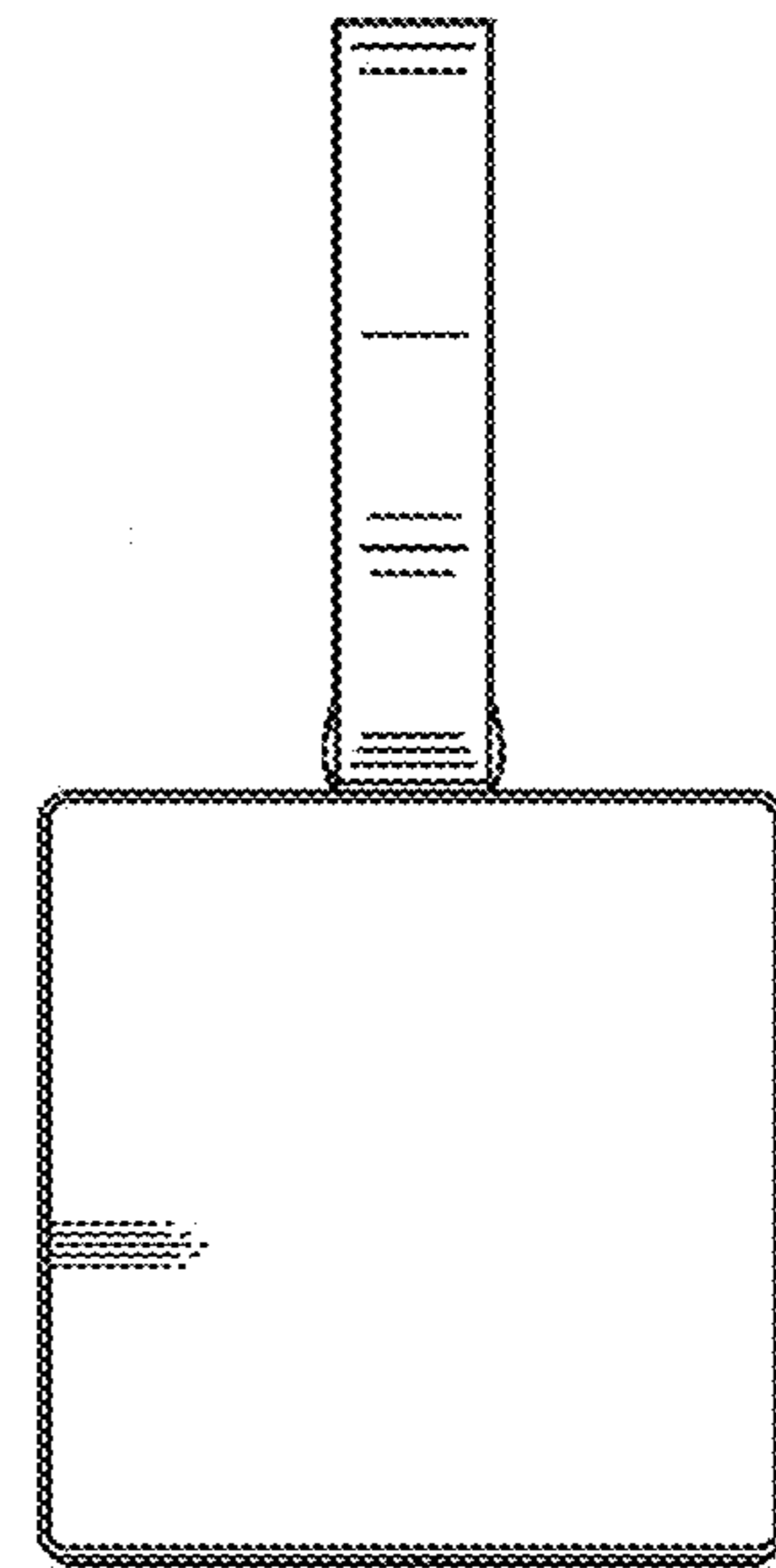

Fig. 7