



US00D787015S

(12) **United States Design Patent**  
**Gibson et al.**

(10) **Patent No.:** **US D787,015 S**  
(45) **Date of Patent:** **\*\* May 16, 2017**

- (54) **FISHING PLIERS**
- (71) Applicant: **Rapala VMC Corp., Helsinki (FI)**
- (72) Inventors: **Stephen Gibson, Columbia, SC (US);  
Jeremy Grayson, Central (HK); Meng  
Da Liu, Mong Kok (HK)**
- (73) Assignee: **Rapala VMC Corporation, Helsinki  
(FI)**
- (\*\*) Term: **15 Years**
- (21) Appl. No.: **29/562,499**
- (22) Filed: **Apr. 26, 2016**
- (51) **LOC (10) Cl.** ..... **22-05**
- (52) **U.S. Cl.**  
USPC ..... **D22/149**
- (58) **Field of Classification Search**  
USPC ..... D22/149, 134; D8/52, 55; 30/271;  
43/4, 44.4, 44.6, 44.8, 53.5; 7/106, 150;  
81/426, 427.5  
CPC ..... A01K 83/06; A01K 97/04; A01K 97/18;  
B25B 7/02; B25B 7/22  
See application file for complete search history.

6,035,748 A *	3/2000	Burch, Jr. ....	B25B 7/02 7/106
6,708,359 B2 *	3/2004	Butts .....	A01K 95/02 7/106
6,983,559 B1 *	1/2006	Kraus .....	A01K 97/18 43/4
7,039,973 B1 *	5/2006	Lehmann .....	A01K 97/00 7/106
7,481,019 B2 *	1/2009	Rosenberg .....	A01K 83/06 43/44.4
D592,923 S *	5/2009	Konopka .....	D8/52
D618,299 S *	6/2010	Steiner .....	D22/149

\* cited by examiner

*Primary Examiner* — Catheri Oliver-Garcia  
(74) *Attorney, Agent, or Firm* — Dority & Manning, P.A.

(57) **CLAIM**

The ornamental design for fishing pliers, as shown and described.

**DESCRIPTION**

FIG. 1 is a perspective view of the fishing pliers according to the present invention;  
FIG. 2 is a side view of the fishing pliers of FIG. 1;  
FIG. 3 is another side view of the fishing pliers of FIG. 1;  
FIG. 4 is a front view of the fishing pliers of FIG. 1;  
FIG. 5 is a rear view of the fishing pliers of FIG. 1;  
FIG. 6 is a top view of the fishing pliers of FIG. 1; and,  
FIG. 7 is a bottom view of fishing pliers of FIG. 1.  
The broken lines shown in FIGS. 1-7 represent portions of the fishing pliers that form no part of the claimed design.  
The dash dot line represents a border that does not form part of the claimed design.

**1 Claim, 5 Drawing Sheets**

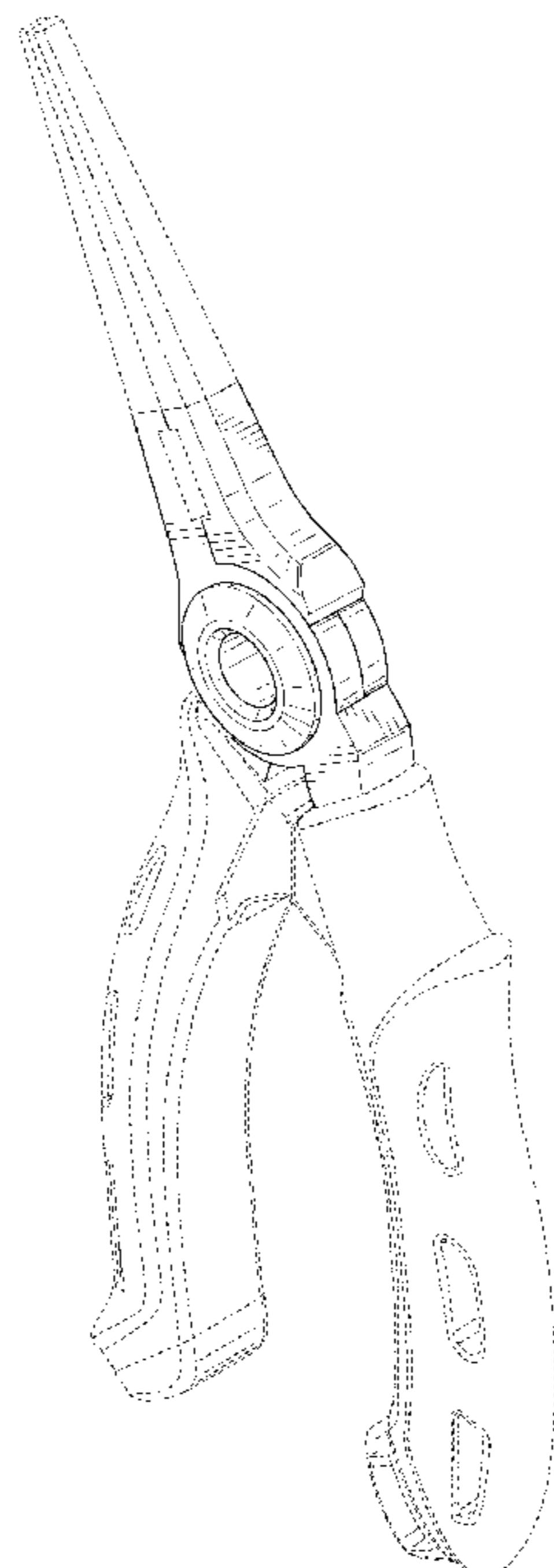

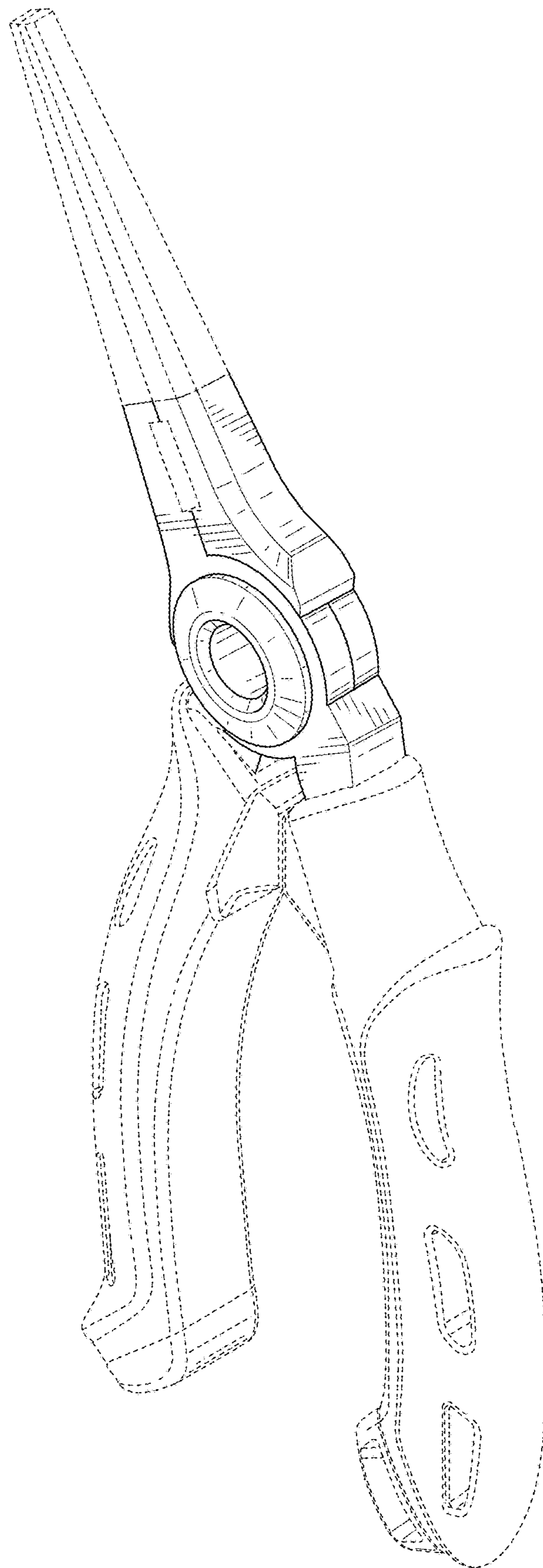

FIG. 1

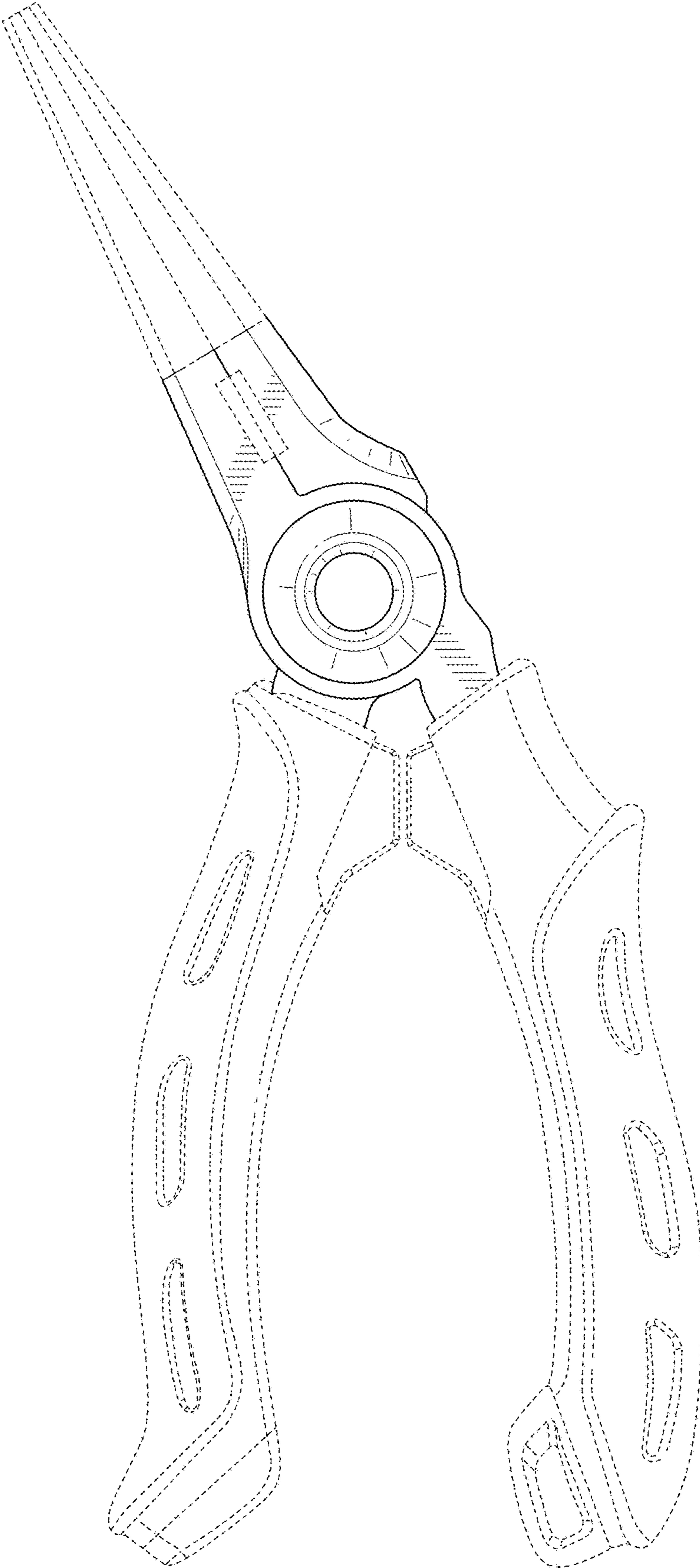

FIG. 2

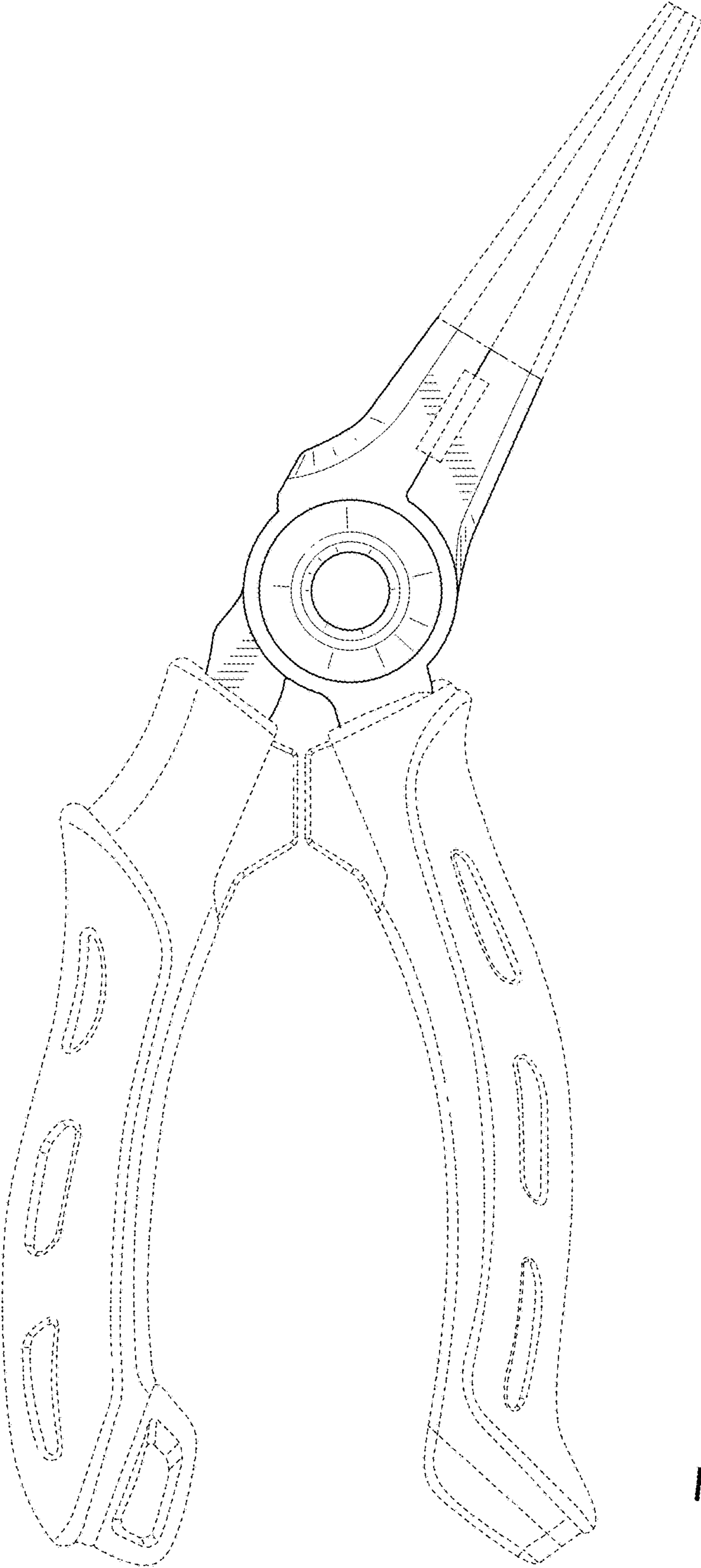

FIG. 3

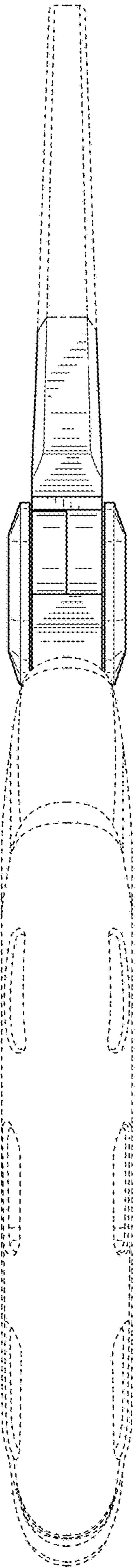
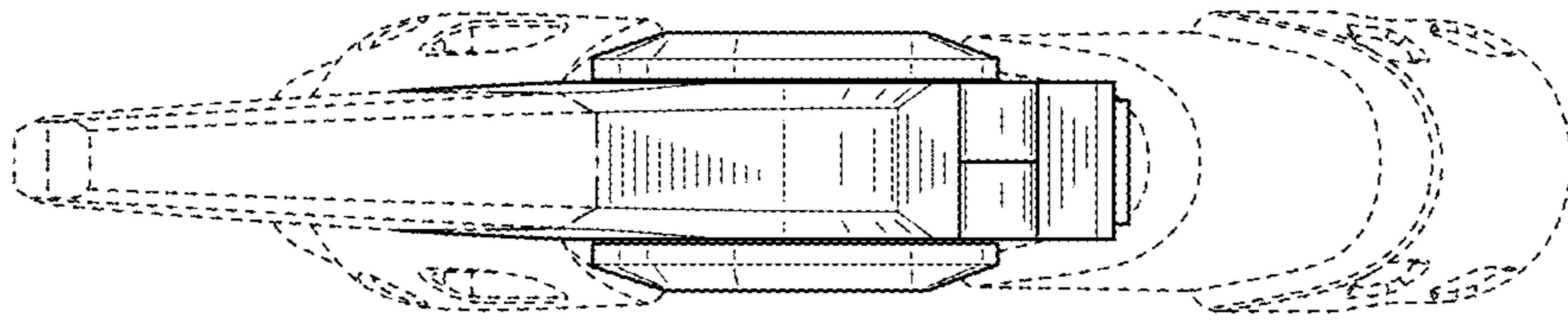

FIG. 4



FIG. 5



**FIG. 6**

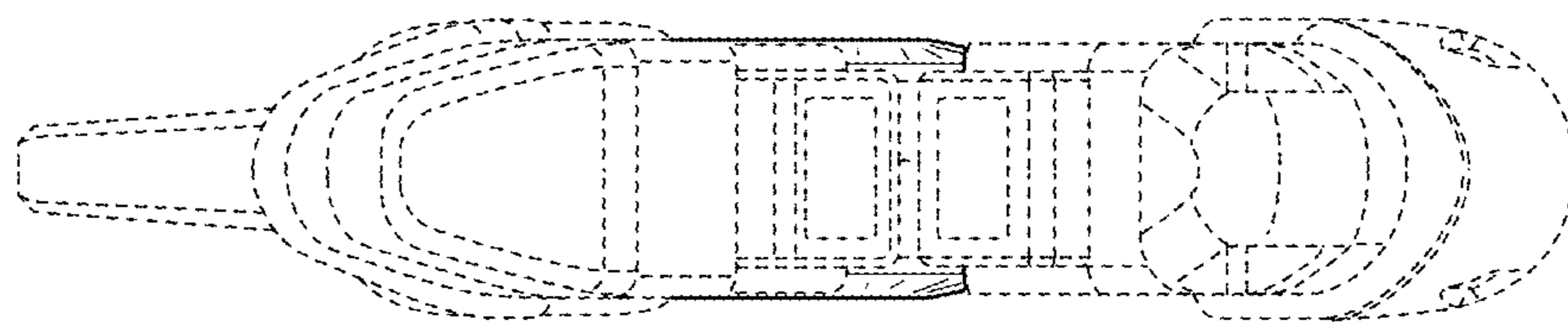

**FIG. 7**