



US00D786998S

(12) **United States Design Patent**  
**Frerich et al.**

(10) **Patent No.:** **US D786,998 S**

(45) **Date of Patent:** **\*\* May 16, 2017**

(54) **FLOTATION DEVICE FOR CHEST COOLER**

(71) Applicants: **Doyle Frerich**, Rosanky, TX (US);  
**Janet Frerich**, Rosanky, TX (US);  
**Shelby T. Frerich**, Rosanky, TX (US)

(72) Inventors: **Doyle Frerich**, Rosanky, TX (US);  
**Janet Frerich**, Rosanky, TX (US);  
**Shelby T. Frerich**, Rosanky, TX (US)

(\*\*) Term: **15 Years**

(21) Appl. No.: **29/527,541**

(22) Filed: **May 20, 2015**

(51) **LOC (10) Cl.** ..... **21-02**

(52) **U.S. Cl.**  
USPC ..... **D21/803**

(58) **Field of Classification Search**  
USPC ..... D21/770, 801, 803–805, 807, 809–810;  
D12/3, 5, 300, 316; D6/392, 601, 604  
CPC ..... A01G 31/02; B65D 85/00; B63B 35/76;  
B63B 7/00; B63B 7/06; B63B 7/08  
See application file for complete search history.

(56) **References Cited**

U.S. PATENT DOCUMENTS

3,099,845	A *	8/1963	Chamberlain	.....	B63C 9/26
					114/190
3,370,310	A *	2/1968	La Tour	.....	B63C 9/00
					441/80
4,487,588	A *	12/1984	Lewis, III	.....	A01G 31/02
					441/43
4,871,079	A *	10/1989	Doucette	.....	A01K 97/04
					220/503
4,927,041	A	5/1990	Hepburn		
4,976,642	A *	12/1990	Wilkie	.....	B63C 9/082
					441/131
5,458,515	A *	10/1995	Buseti	.....	B63C 9/26
					441/81
5,518,431	A	5/1996	Staley		
D388,489	S *	12/1997	Sikorski	.....	D21/803

D388,490	S *	12/1997	Sikorski	.....	D21/803
6,016,933	A *	1/2000	Daily	.....	B63B 22/24
					220/560
D423,809	S *	5/2000	Lund	.....	D21/803
7,018,258	B2	3/2006	McLarty		
D545,407	S *	6/2007	Chiu	.....	D23/284
8,215,515	B2	7/2012	Churchill		
D705,376	S *	5/2014	Rubey	.....	D21/803
D741,976	S *	10/2015	Lagier	.....	D21/803

(Continued)

OTHER PUBLICATIONS

“Flotation device for ice chest,” [online], retrieved Jul. 22, 2016, retrieved from <<https://forsalebyinventor.com/products/portfolio-item/flotation-device-for-ice-chest/>>.\*

(Continued)

*Primary Examiner* — Karen Kearney  
*Assistant Examiner* — Debra Callahan  
(74) *Attorney, Agent, or Firm* — Robert C. Montgomery;  
Montgomery Patent & Design LP.

(57) **CLAIM**

The ornamental design for a flotation device for chest cooler, as shown and described.

**DESCRIPTION**

FIG. 1 is a perspective front view of the flotation device for chest cooler, showing our new design; FIG. 2 is a front side view thereof; FIG. 3 is a back side view thereof; FIG. 4 is left side view with the right side view being a mirror image thereof; FIG. 5 is a top side view thereof; and, FIG. 6 is a bottom side view thereof. The broken lines immediately adjacent to the claimed subject matter illustrate portions of the flotation device for chest cooler and form no part of the claimed design.

**1 Claim, 5 Drawing Sheets**

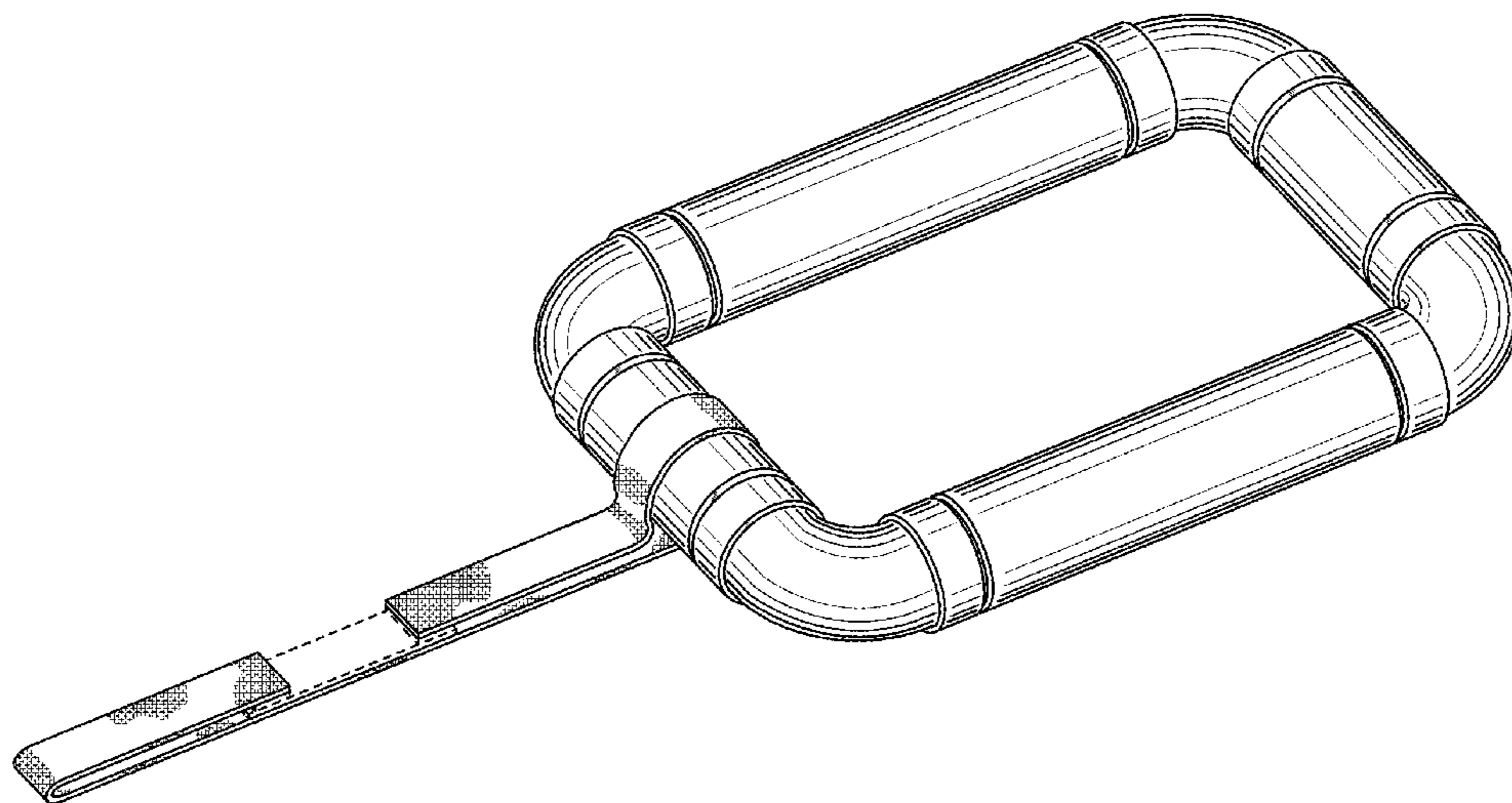

(56)

References Cited

U.S. PATENT DOCUMENTS

2005/0208849 A1\* 9/2005 Ferrara ..... B63B 7/082  
441/129  
2012/0005957 A1\* 1/2012 Downs, Sr. .... A01G 31/02  
47/62 A  
2013/0105346 A1\* 5/2013 Ramkhelawan ..... A61B 50/20  
206/370  
2014/0216966 A1\* 8/2014 Ramkhelawan ..... B65B 5/08  
206/370  
2014/0308861 A1\* 10/2014 Hanel ..... B63B 35/74  
441/130  
2015/0038030 A1\* 2/2015 White ..... B63C 9/23  
441/88  
2015/0113875 A1\* 4/2015 Liotta ..... A01G 7/045  
47/62 R  
2015/0366150 A1\* 12/2015 Anderson ..... A01G 31/02  
47/62 R  
2016/0176483 A1\* 6/2016 Chiang ..... B63C 9/04  
114/274  
2016/0194058 A1\* 7/2016 Ries ..... B63B 22/00  
441/6

OTHER PUBLICATIONS

“Sevylor inflatable cooler float,” [online], posted Aug. 21, 2016, retrieved Aug. 22, 2016, retrieved from <[http://www.ebay.com/itm/Sevylor-Inflatable-Cooler-Float/172239709760?\\_trksid=p2047675.c100005.m1851&\\_trkparms=aid%3D222007/026algo%3DSIC.MBE%26ao%3D1%26asc%3D38636%26meid%>](http://www.ebay.com/itm/Sevylor-Inflatable-Cooler-Float/172239709760?_trksid=p2047675.c100005.m1851&_trkparms=aid%3D222007/026algo%3DSIC.MBE%26ao%3D1%26asc%3D38636%26meid%>)>.\*  
“Floating speaker cooler...beatzcoolersby.jp,” [online], posted Mar. 4, 2013, retrieved Aug. 22, 2016, retrieved from <<https://www.youtube.com/watch?v=x9DYFNZdCZQ>>.\*  
“Building an oyster float,” [online], posted Sep. 29, 2010, retrieved Aug. 23, 2016, retrieved from <[https://www.youtube.com/watch?v=T1\\_g4H7Fe3c](https://www.youtube.com/watch?v=T1_g4H7Fe3c)>.\*  
“Capt. Tom’s oyster floats,” [online], posted Mar. 22, 2014, retrieved Sep. 7, 2016, retrieved from <<https://www.facebook.com/205113202848243/photos/a.211371508889079.68056.205113202848243/865368423489381/?type=3&theater>>.\*

\* cited by examiner

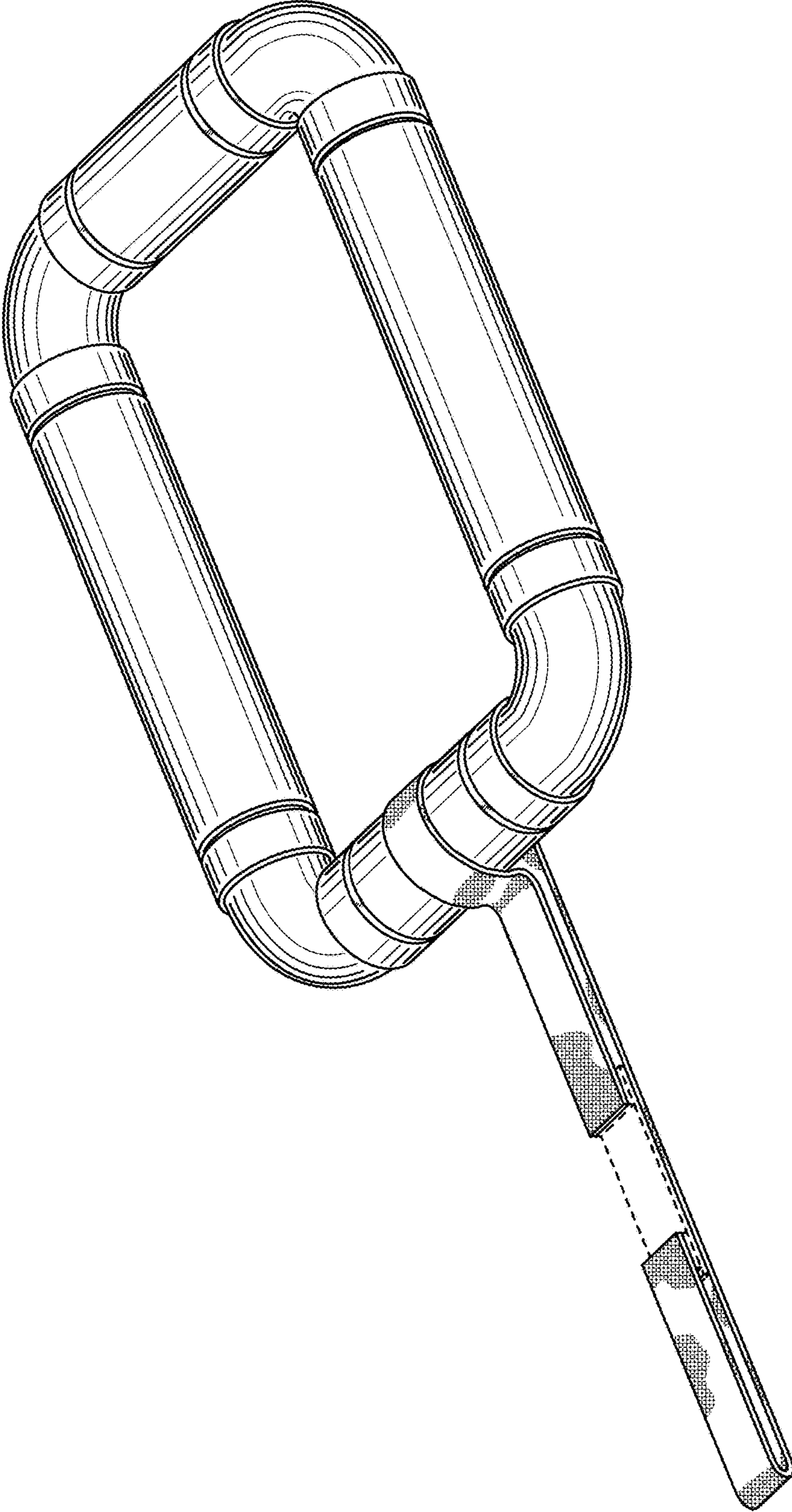

FIG. 1

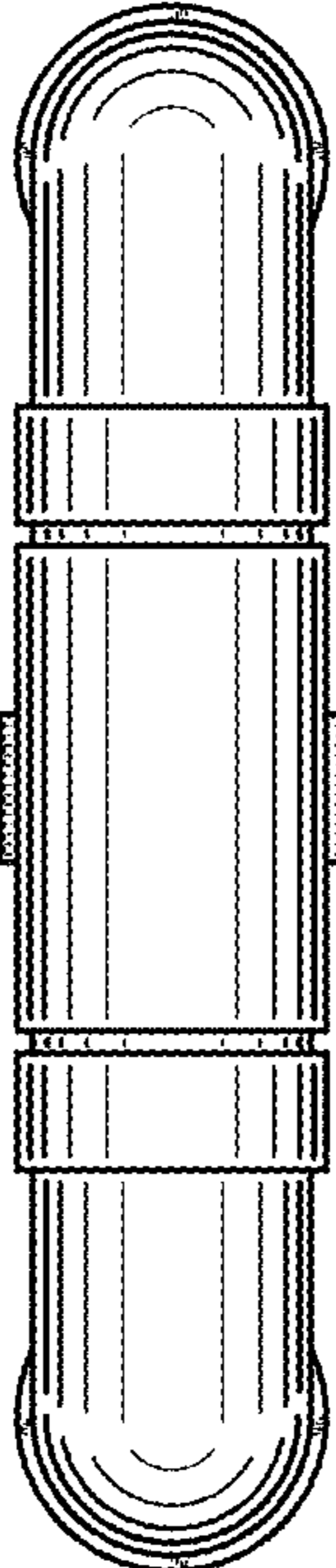

FIG. 3

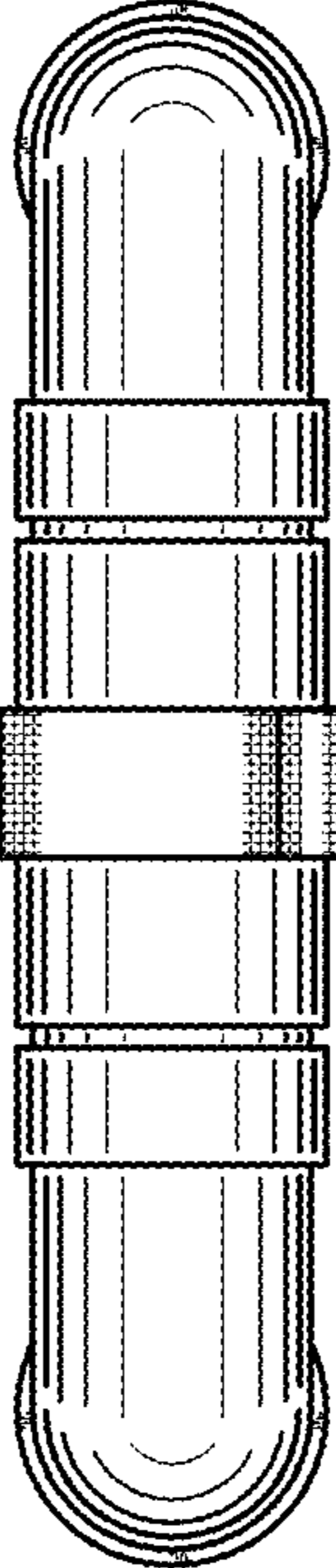

FIG. 2

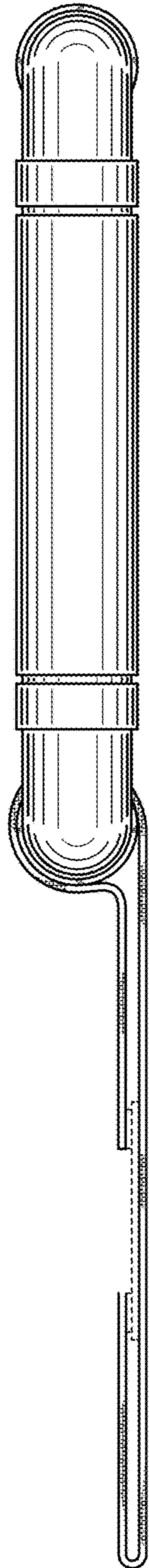

FIG. 4

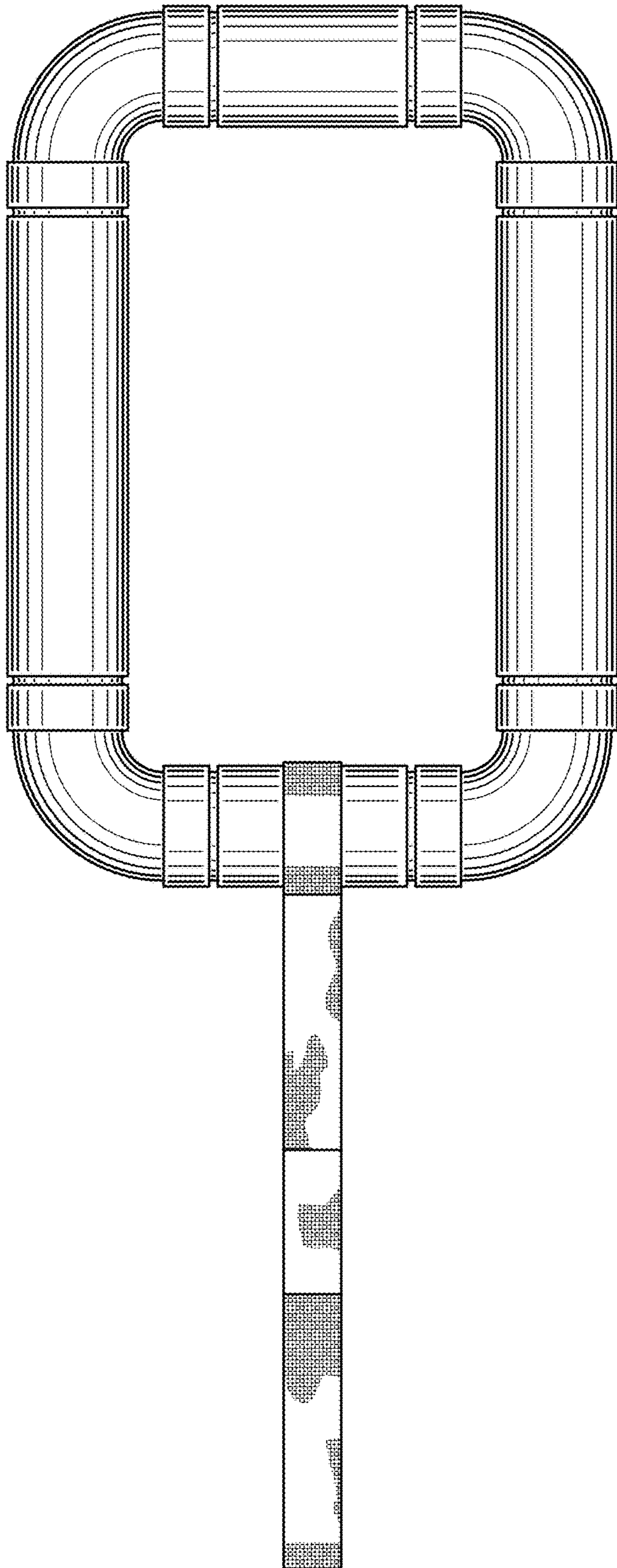

FIG. 5

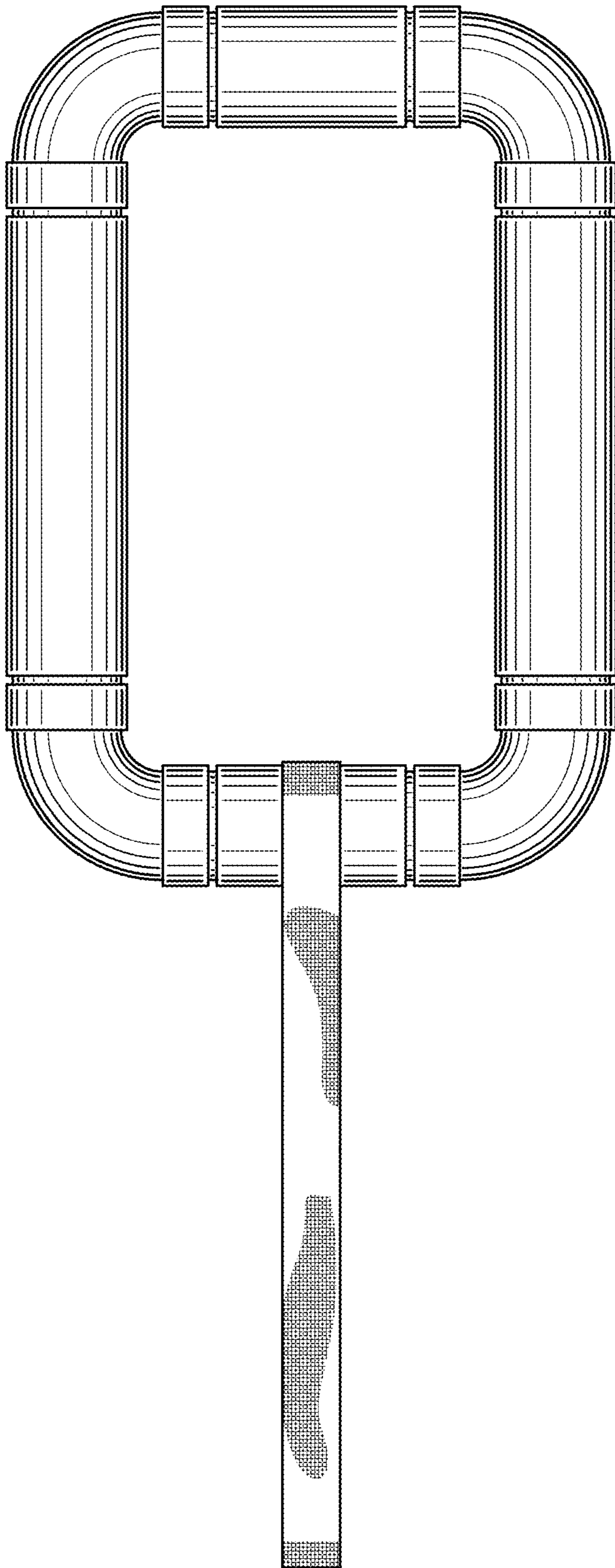

FIG. 6