

US00D786665S

(12) **United States Design Patent** (10) **Patent No.:** **US D786,665 S**
Lee (45) **Date of Patent:** **** May 16, 2017**

(54) **WIDE BOX SET FOR TIES**
(71) Applicant: **In Y. Lee**, Great Neck, NY (US)
(72) Inventor: **In Y. Lee**, Great Neck, NY (US)
(**) Term: **15 Years**
(21) Appl. No.: **29/564,152**
(22) Filed: **May 11, 2016**
(51) **LOC (10) Cl.** **09-03**
(52) **U.S. Cl.**
USPC **D9/418**
(58) **Field of Classification Search**
USPC D9/415, 414, 418, 432, 499, 711, 721;
D2/600, 999; 2/145; 206/232, 278, 769;
223/DIG. 1, 85, 97; 229/406, 915
CPC ... B65D 1/00; B65D 1/22; B65D 1/24; B65D
1/26; B65D 65/00; B65D 65/10; B65D
5/422; B65D 5/6661; B65D 5/48024
See application file for complete search history.

(56) **References Cited**
U.S. PATENT DOCUMENTS
D270,617 S * 9/1983 Skowronski D9/415
D276,024 S * 10/1984 Skowronski D9/415
D309,430 S * 7/1990 Cramer D9/415
D309,569 S * 7/1990 Grazi D9/415
D373,308 S * 9/1996 Chapman D9/415
D429,637 S * 8/2000 Kumakura D9/415
D485,172 S * 1/2004 Defino, Jr. D9/415
D589,363 S * 3/2009 Vandecasteele D9/721
D589,364 S * 3/2009 Kim D9/721
D589,365 S * 3/2009 Kim D9/721
D589,366 S * 3/2009 Kim D9/721
D589,367 S * 3/2009 Kim D9/721
D590,724 S * 4/2009 Kim D9/721
D590,725 S * 4/2009 Kim D9/721
D590,726 S * 4/2009 Kim D9/721
D596,498 S * 7/2009 Kim D9/721

D609,116 S * 2/2010 Kim D9/721
D609,117 S * 2/2010 Kim D9/721
D681,444 S * 5/2013 Oja D9/418
D691,884 S * 10/2013 Kwon D9/415
D699,563 S * 2/2014 McAdam D9/418
D717,160 S * 11/2014 Kurniawan D9/415
D734,142 S * 7/2015 Lee D9/414
D752,428 S * 3/2016 Lee D9/418
2008/0093257 A1 * 4/2008 Kim B65D 5/4204
206/769

* cited by examiner

Primary Examiner — Wan Laymon
Assistant Examiner — Clint A Samuel
(74) *Attorney, Agent, or Firm* — Notaro, Michalos & Zaccaria P.C.

(57) **CLAIM**

The ornamental design for a wide box set for ties, as shown and described.

DESCRIPTION

FIG. 1 is a front, top, left perspective view of a wide box set for ties showing my new design;
FIG. 2 is a rear, top, left perspective view thereof;
FIG. 3 is a front elevational view thereof;
FIG. 4 is a rear elevational view thereof;
FIG. 5 is a right side elevational view thereof, the left side elevational view being identical;
FIG. 6 is a top plan view thereof;
FIG. 7 is a bottom plan view thereof; and,
FIG. 8 is a perspective view showing my design in the environment of two ties, two rolled handkerchiefs, and a tie clip, the two ties, two rolled handkerchiefs, and tie clip shown in phantom line and forming no part of the design. The broken lines shown in drawings are included for the purpose of illustrating unclaimed portions of the wide box set for ties and form no part of the claimed design.

1 Claim, 7 Drawing Sheets

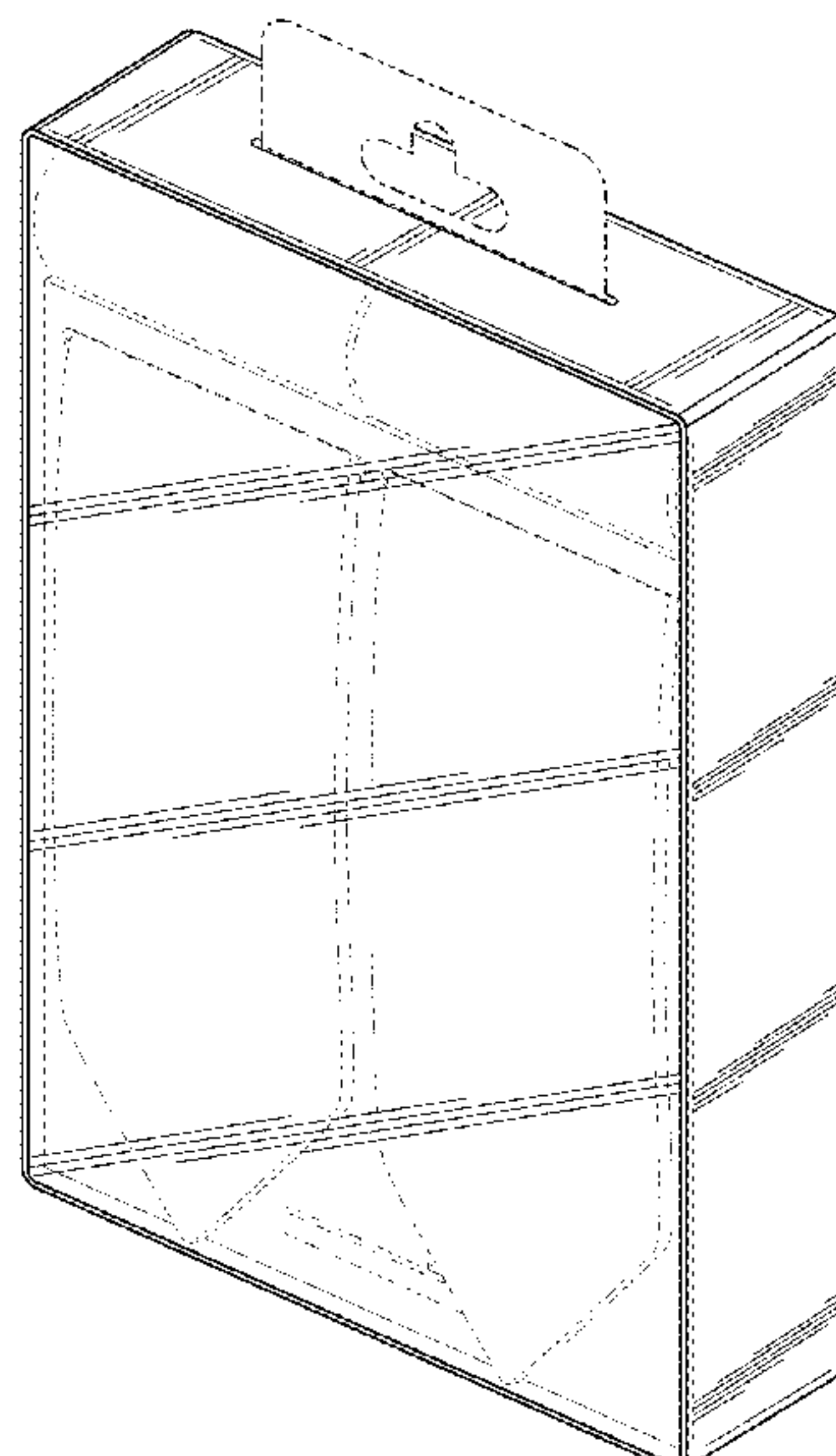
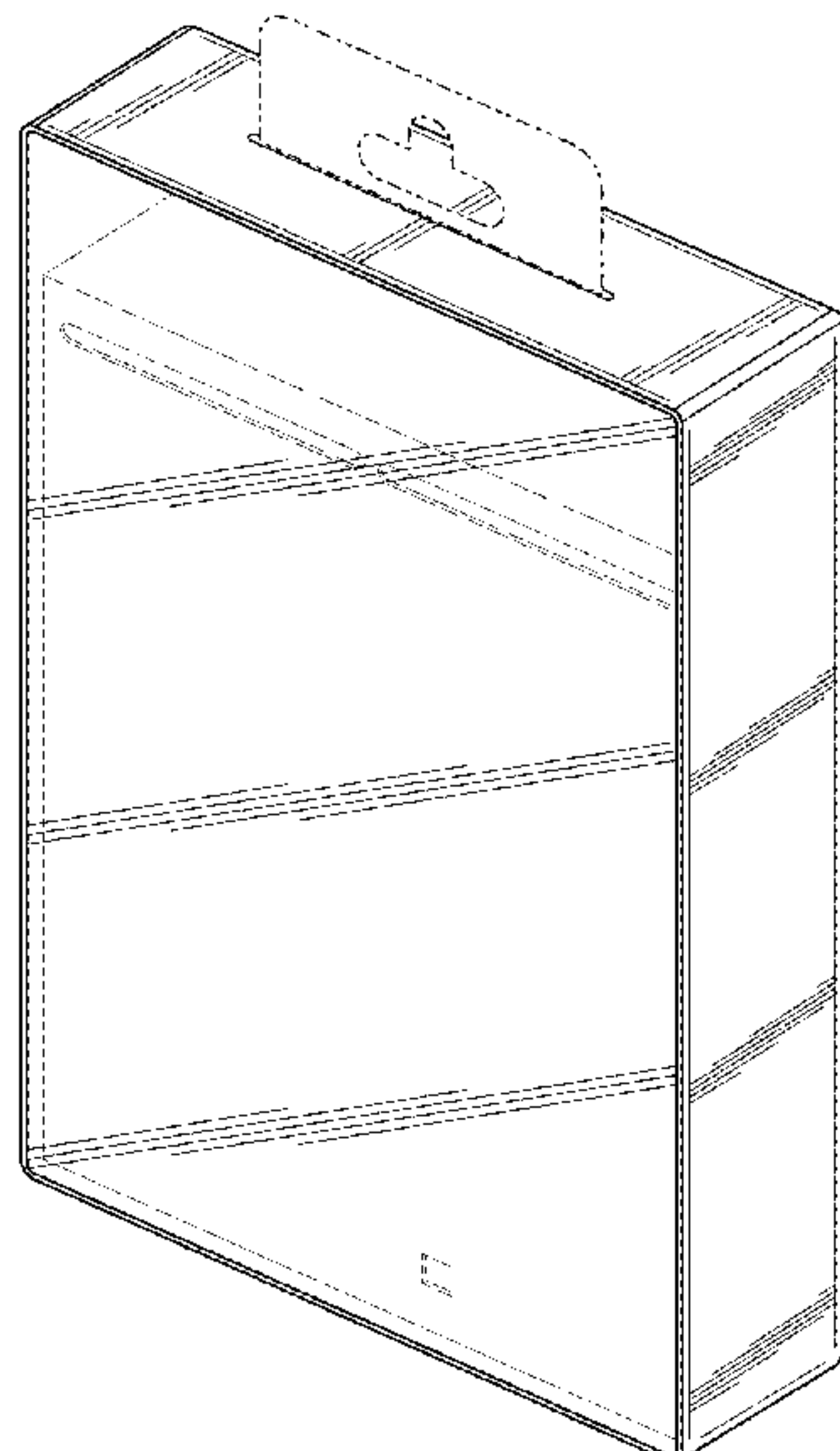

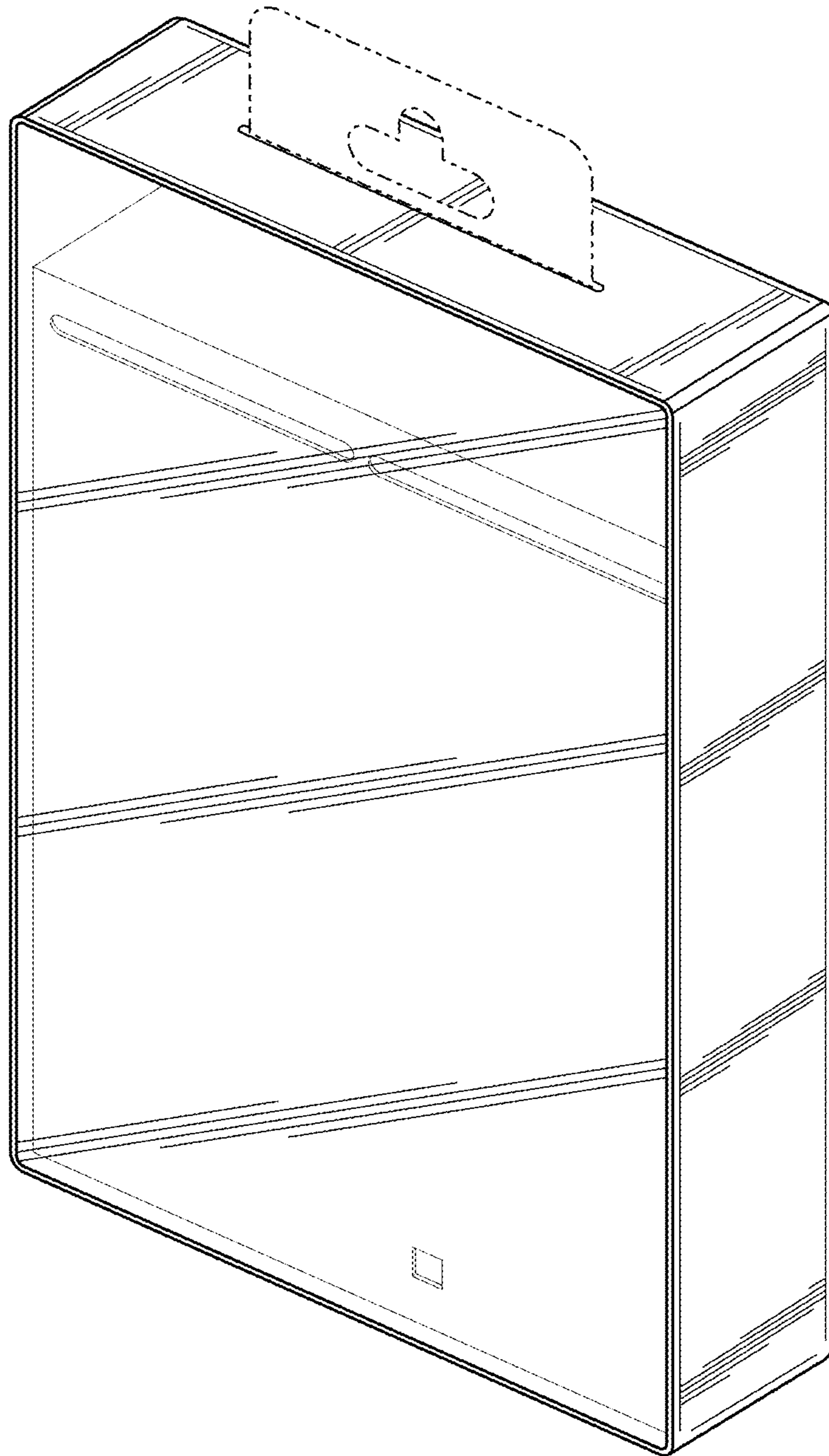

FIG. 1

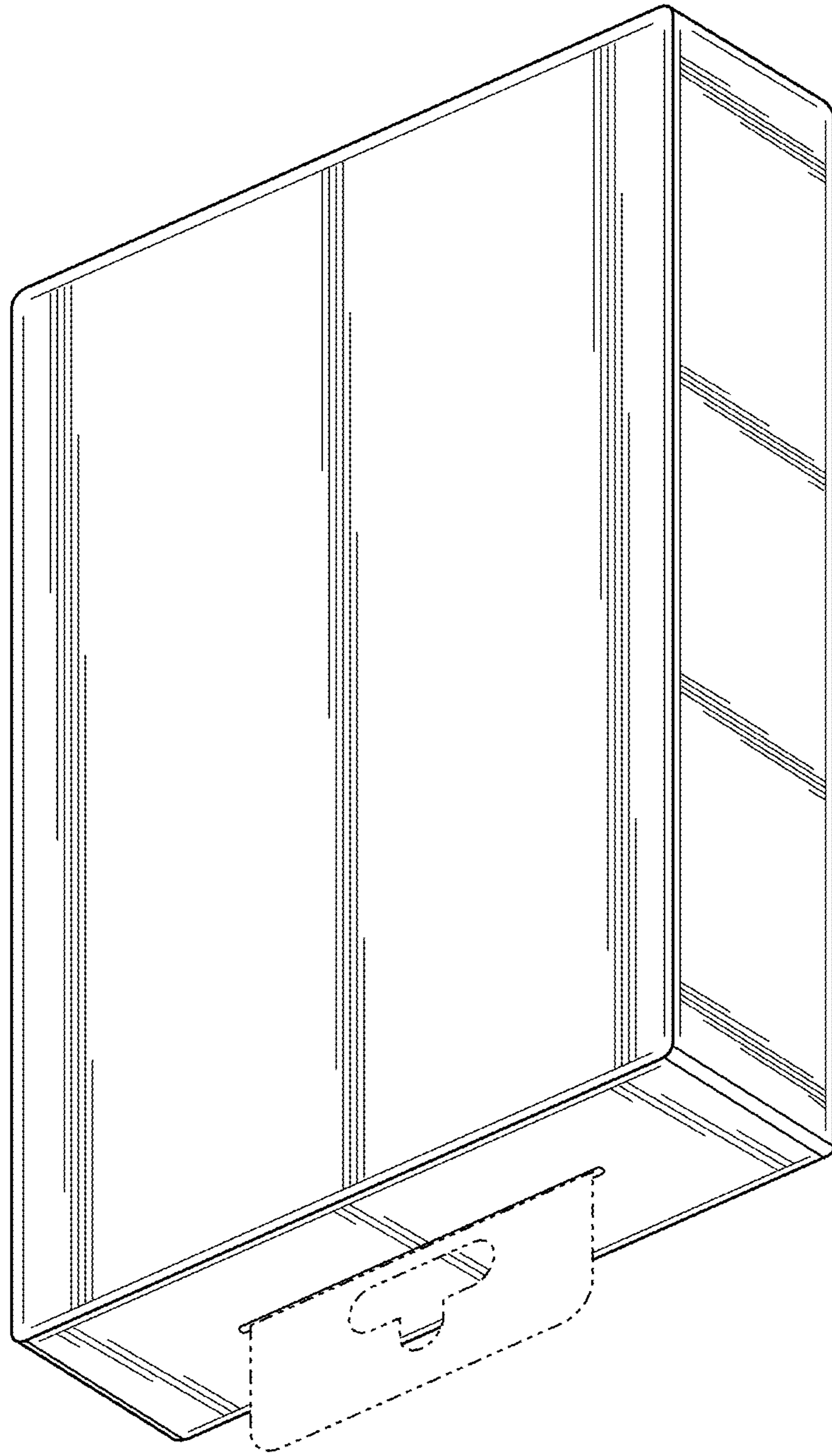

FIG. 2

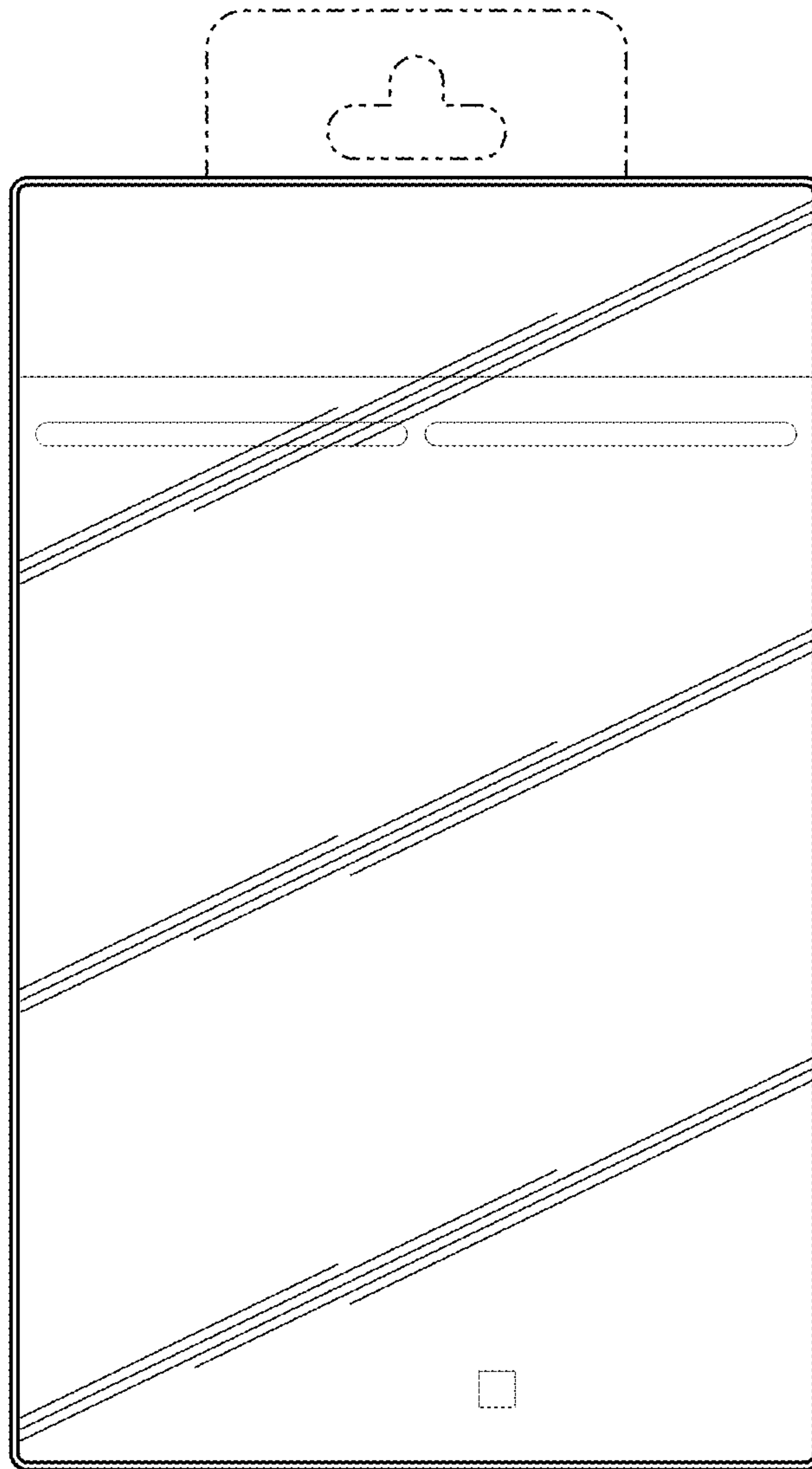

FIG. 3

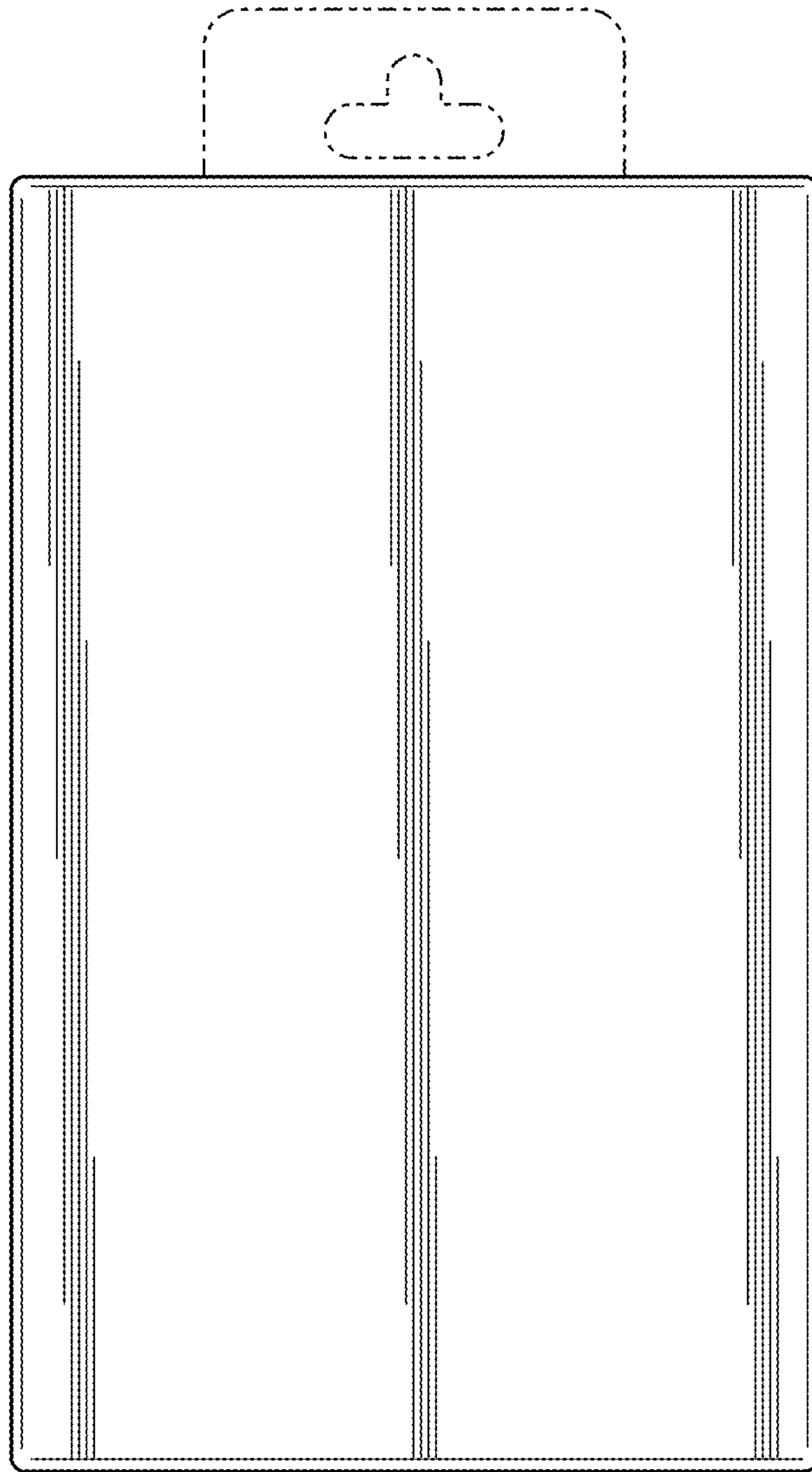

FIG. 4

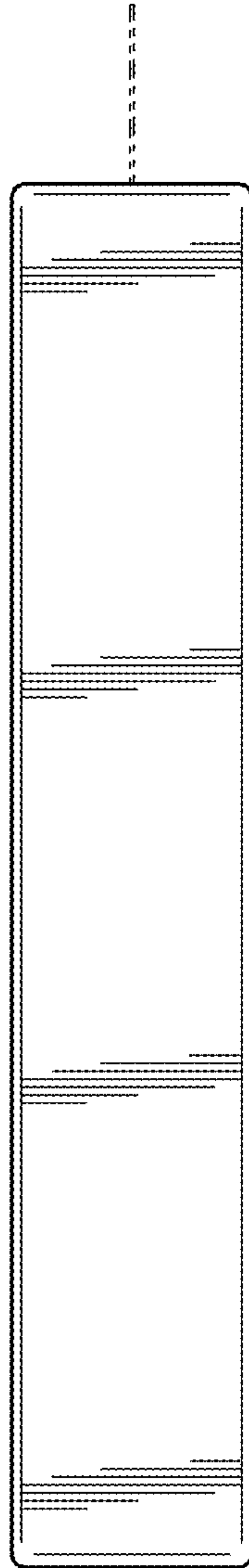

FIG. 5

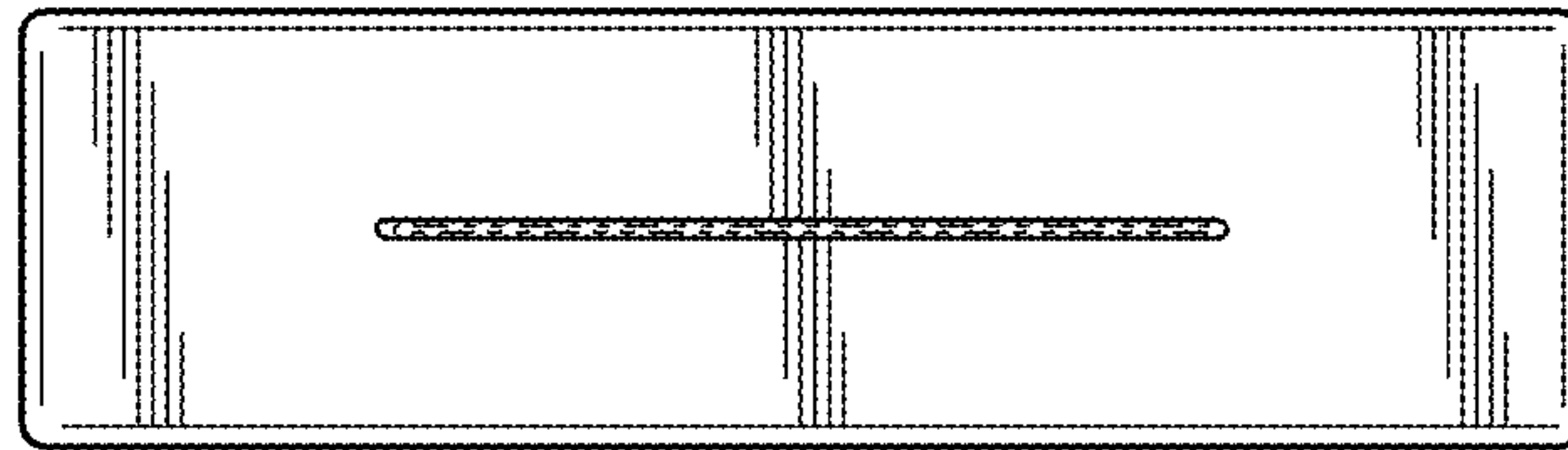

FIG. 6

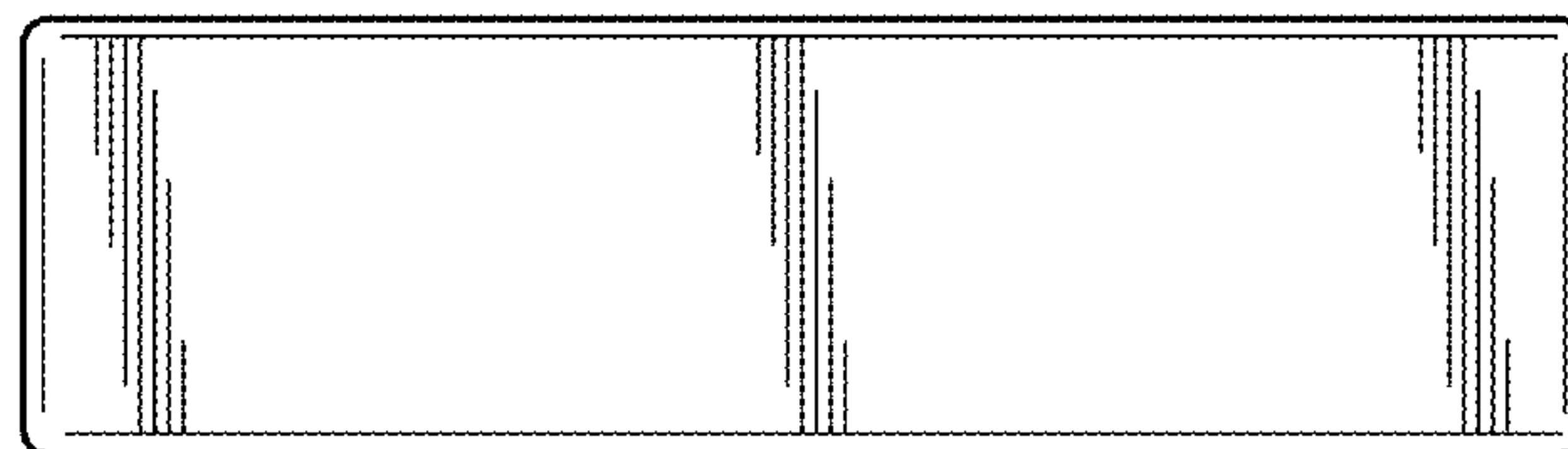

FIG. 7

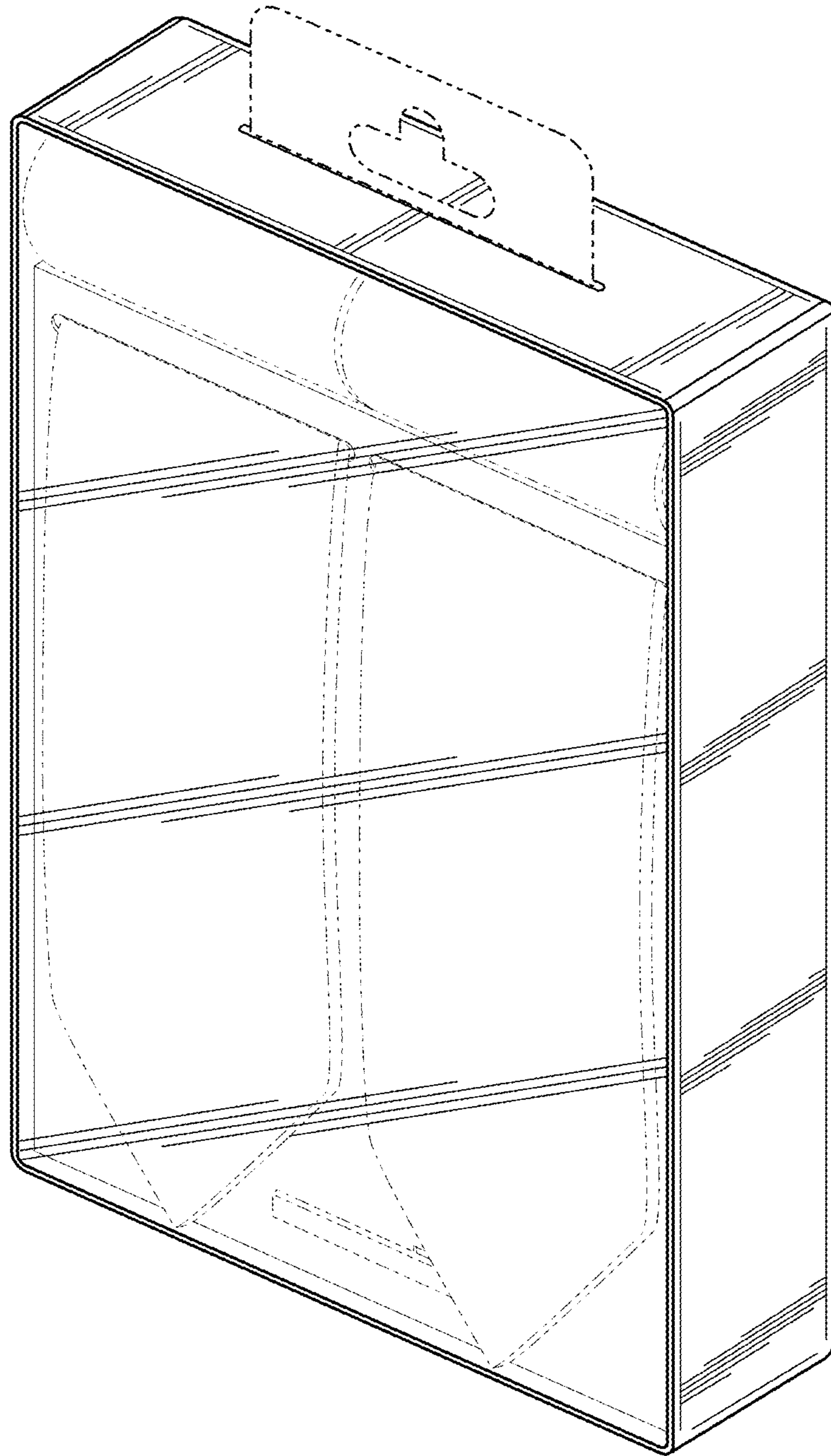

FIG. 8