



US00D786534S

(12) **United States Design Patent** (10) **Patent No.:** **US D786,534 S**  
**Alligood et al.** (45) **Date of Patent:** **\*\* May 16, 2017**

(54) **LOWER BODY GARMENT**

D618,435 S 6/2010 Iamartino et al.  
D619,784 S 7/2010 Kanada et al.  
D641,127 S \* 7/2011 Zarabi ..... D2/701  
(Continued)

(71) Applicant: **Under Armour, Inc.**, Baltimore, MD (US)

(72) Inventors: **Elyse Alligood**, New York, NY (US);  
**Meghan Kelley**, New York, NY (US)

(73) Assignee: **Under Armour, Inc.**, Baltimore, MD (US)

(\*\*) Term: **15 Years**

(21) Appl. No.: **29/558,673**

(22) Filed: **Mar. 21, 2016**

(51) **LOC (10) Cl.** ..... **02-02**

(52) **U.S. Cl.**

USPC ..... **D2/731; D2/742**

(58) **Field of Classification Search**

USPC ..... D2/742, 731, 748, 738, 743, 747, 745,  
D2/861, 863, 864

CPC . A41D 1/06; A41D 1/08; A41D 1/067; A41D  
1/062; A41D 1/082; A41D 1/084; A41D  
1/086; A41D 1/088; A41D 7/00; A41D  
7/001; A41D 7/005; A41D 7/006

See application file for complete search history.

(56) **References Cited**

**U.S. PATENT DOCUMENTS**

D235,937 S	7/1975	Froidh
D275,619 S	9/1984	Birring
D281,540 S	12/1985	Ternstrom
D284,036 S	6/1986	Birring
5,954,564 A	9/1999	Ganz
D514,774 S	2/2006	Africa et al.
D532,958 S	12/2006	Kent
D613,037 S	4/2010	Iamartino et al.
D613,928 S	4/2010	Iamartino et al.
D615,279 S	5/2010	Savage
D618,434 S	6/2010	Iamartino et al.

**OTHER PUBLICATIONS**

Athleta Catalog, Runabout Pant, Item J, p. 37, Fall 2011, Petaluma, California.

(Continued)

*Primary Examiner* — Robin V Webster

*Assistant Examiner* — James Thorn, Sr.

(57) **CLAIM**

The ornamental design for a lower body garment, as shown and described.

**DESCRIPTION**

FIG. 1 is a perspective view of a lower body garment showing my new design;

FIG. 2 is a front view in elevation thereof;

FIG. 3 is a rear view in elevation thereof;

FIG. 4 is a left side view in elevation thereof;

FIG. 5 is a right side view in elevation thereof;

FIG. 6 is a top plan view thereof; and

FIG. 7 is a bottom plan view thereof.

FIG. 8 is a perspective view of a lower body garment, according to another embodiment

FIG. 9 is a front view in elevation thereof;

FIG. 10 is a rear view in elevation thereof;

FIG. 11 is a left side view in elevation thereof;

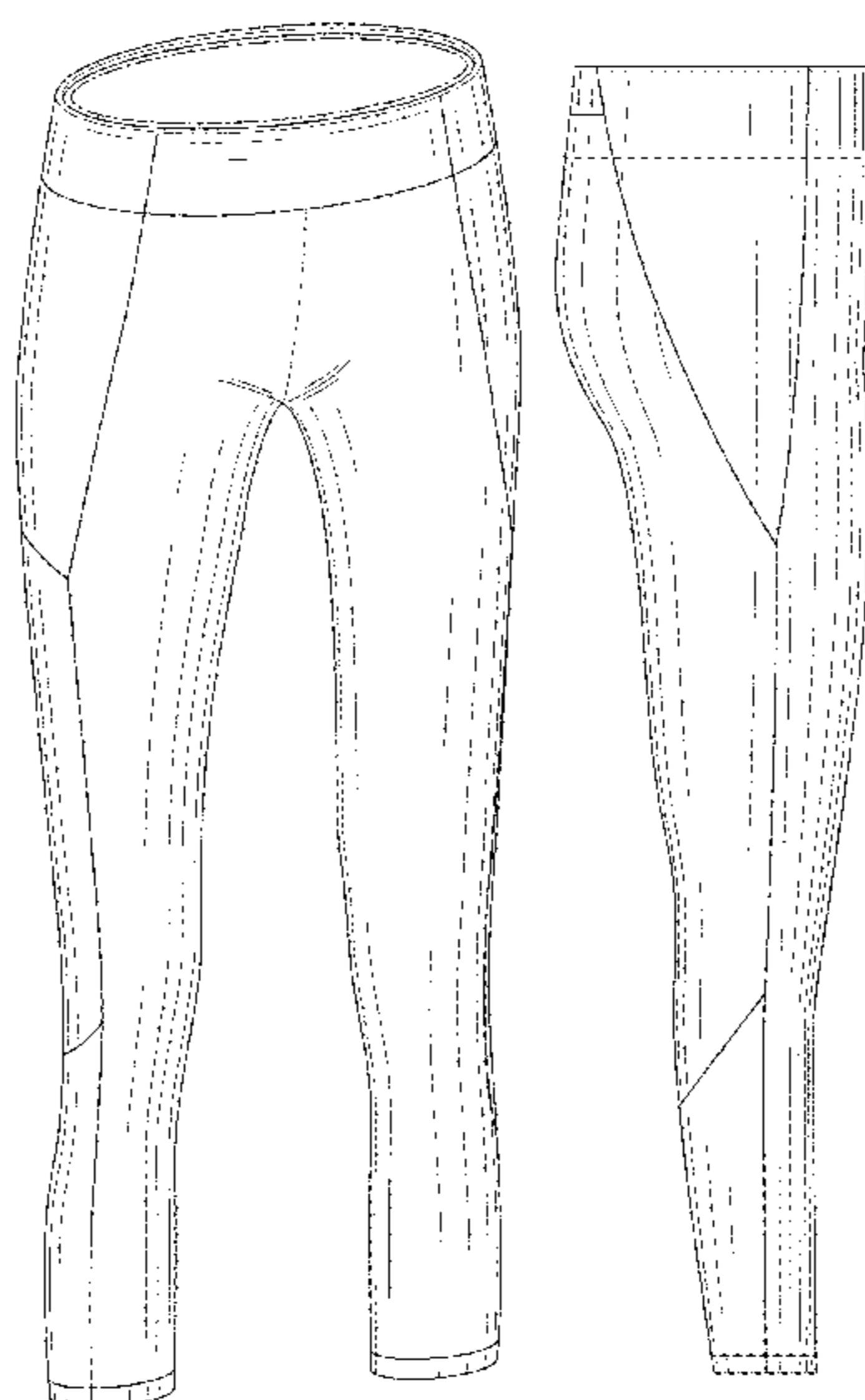
FIG. 12 is a right side view in elevation thereof;

FIG. 13 is a top plan view thereof; and,

FIG. 14 is a bottom plan view thereof.

The broken, dashed lines in the figures are not part of the claimed design. The broken, dot-dash lines in FIGS. 6, 7, 13, and 14, defining the bounds of the claimed design, form no part thereof. The stipple shading in FIGS. 8-14 represents a contrast of appearance and does not represent any particular color, texture, or material.

**1 Claim, 12 Drawing Sheets**



(56)

**References Cited**

U.S. PATENT DOCUMENTS

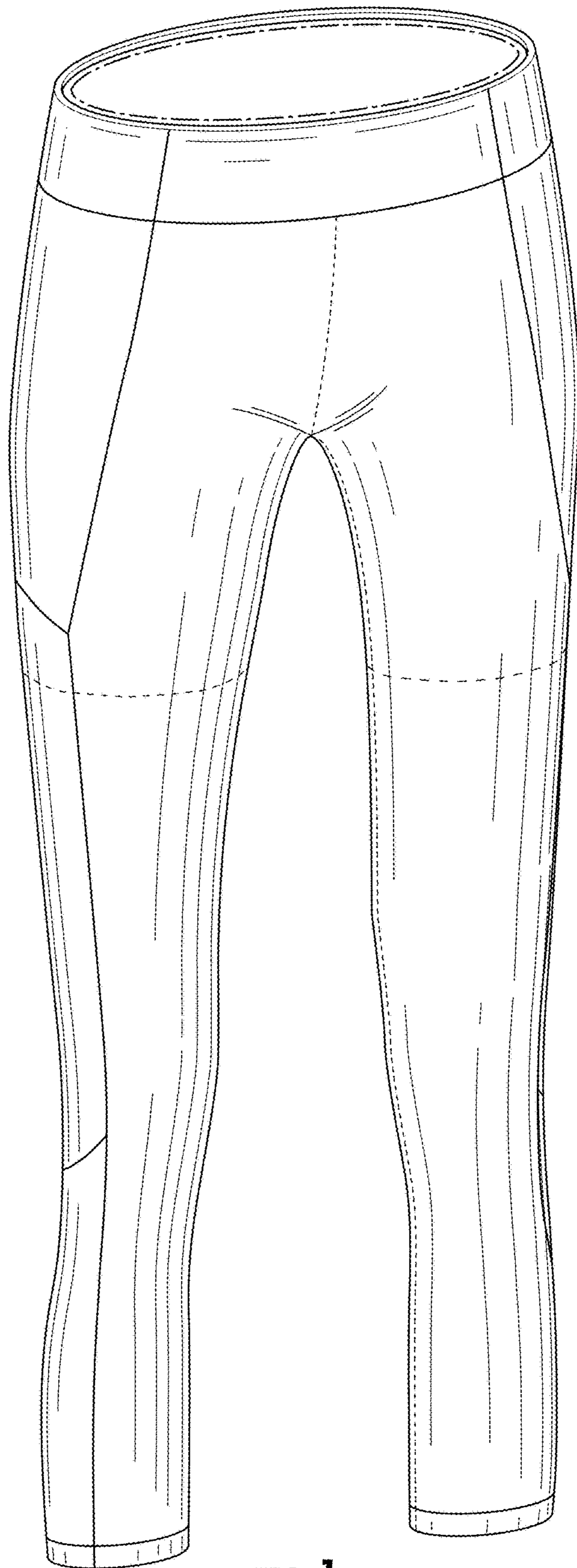
D641,134	S	7/2011	Zarabi	
D641,539	S *	7/2011	Zarabi .....	D2/701
D645,644	S	9/2011	Iamartino	
D654,661	S	2/2012	Savage	
D660,553	S	5/2012	Farina et al.	
D661,872	S	6/2012	Iamartino	
D662,281	S	6/2012	Iamartino	
D668,434	S	10/2012	Iamartino	
D673,756	S	1/2013	Agnew et al.	
D686,801	S	7/2013	Farina	
D687,214	S	8/2013	Farina et al.	
D688,032	S *	8/2013	Harte .....	D2/742
D698,520	S *	2/2014	Anderson .....	D2/742
D731,753	S *	6/2015	Mahtani .....	D2/742
D741,574	S *	10/2015	Michaeloff .....	D2/742
D746,545	S *	1/2016	Kositchiranant .....	D2/742
D750,346	S *	3/2016	McManus .....	D2/742
D764,754	S *	8/2016	McManus .....	D2/742
D767,254	S *	9/2016	Bickley .....	D2/742
D769,579	S *	10/2016	Griffin .....	D2/742
D770,133	S *	11/2016	Burke .....	D2/731
2008/0083055	A1	4/2008	Onda	
2011/0131705	A1	6/2011	Waldman et al.	
2012/0036615	A1	2/2012	Bradstreet et al.	

OTHER PUBLICATIONS

Athleta Catalog, Organic Cotton Salamba Pant, p. 64, Fall 2011, Petaluma, California.

Athleta Catalog, Kickbooty Pant, p. 65, Fall 2011, Petaluma, California.

\* cited by examiner



**FIG. 1**

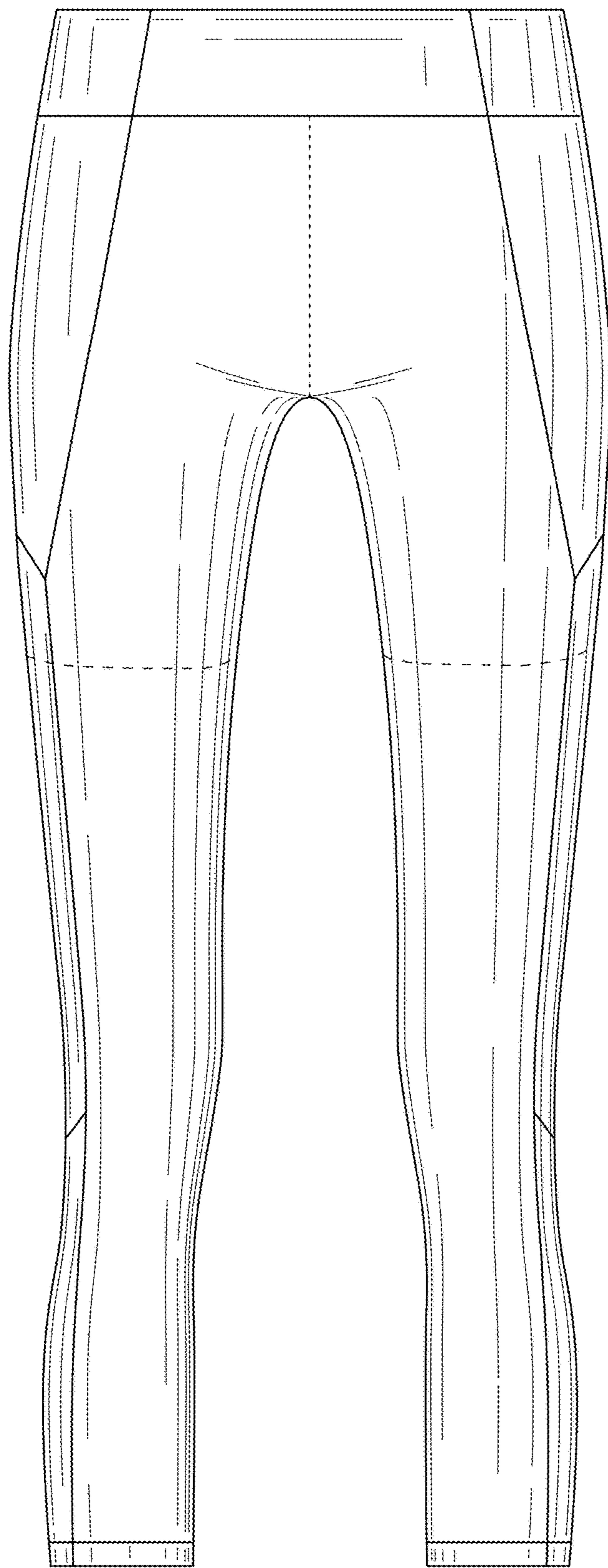
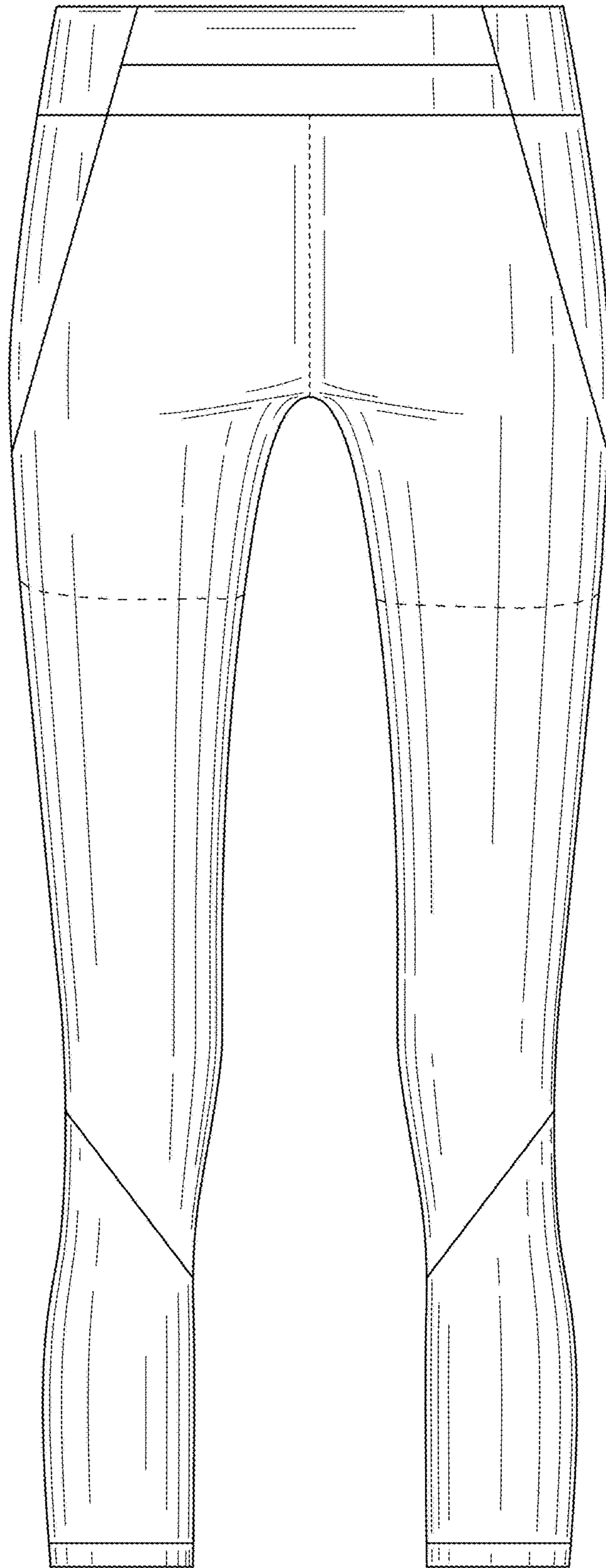


FIG. 2



**FIG. 3**

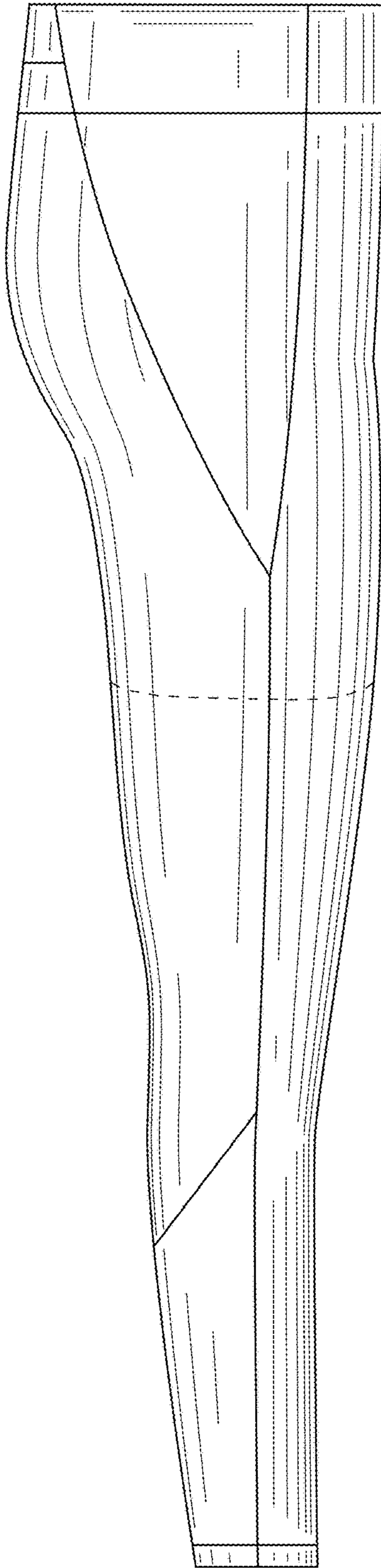
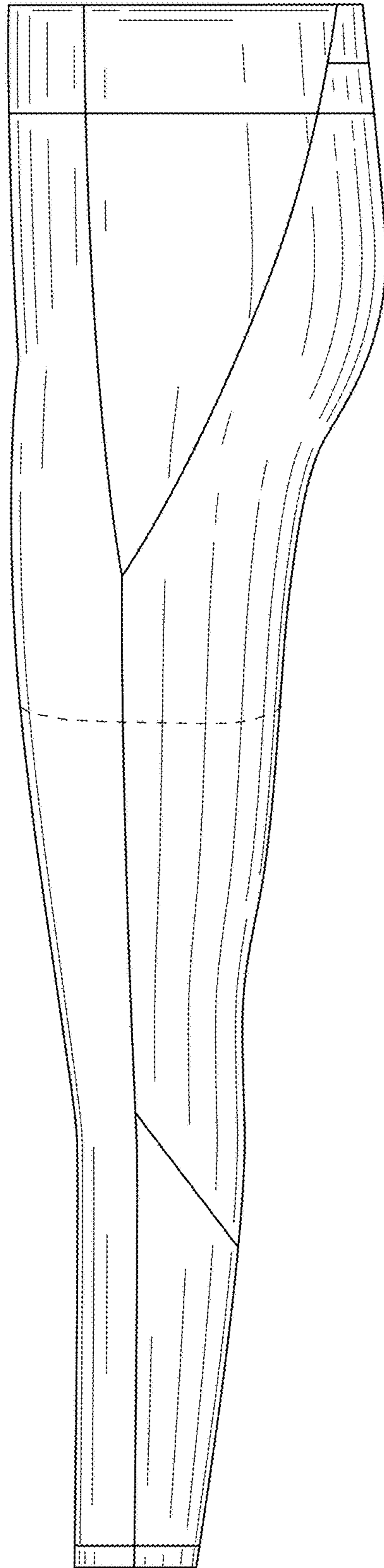
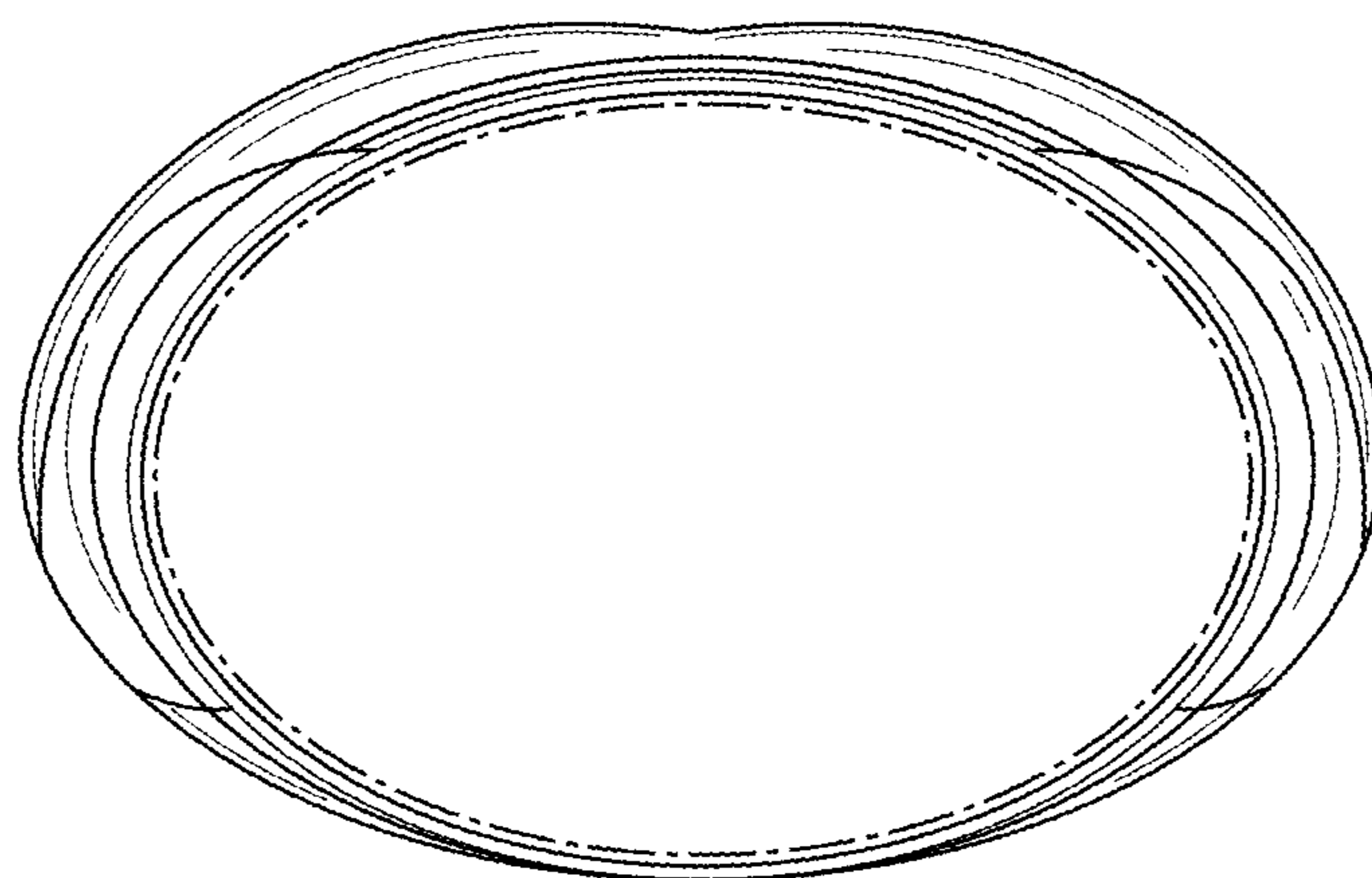


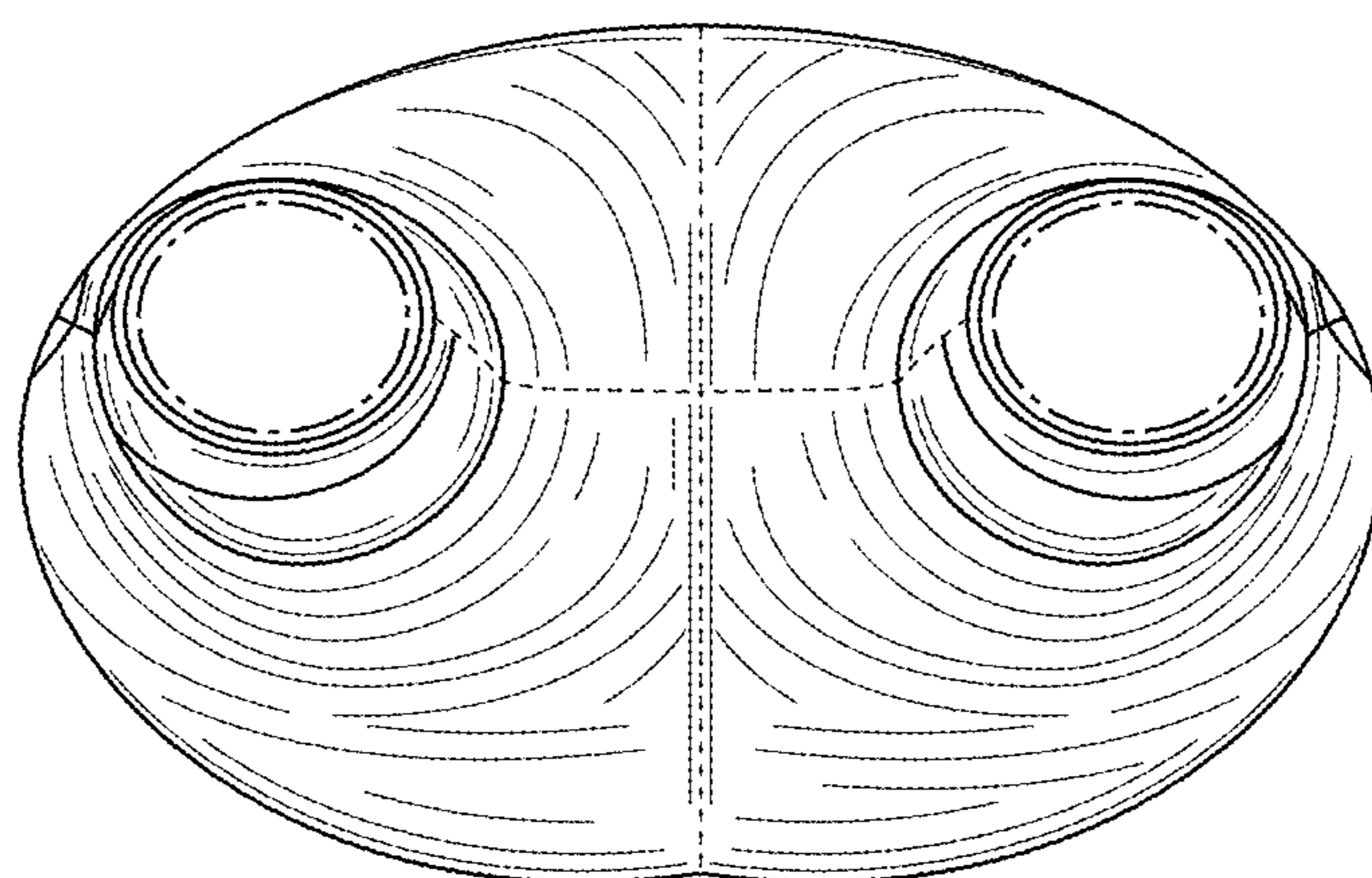
FIG. 4



**FIG. 5**

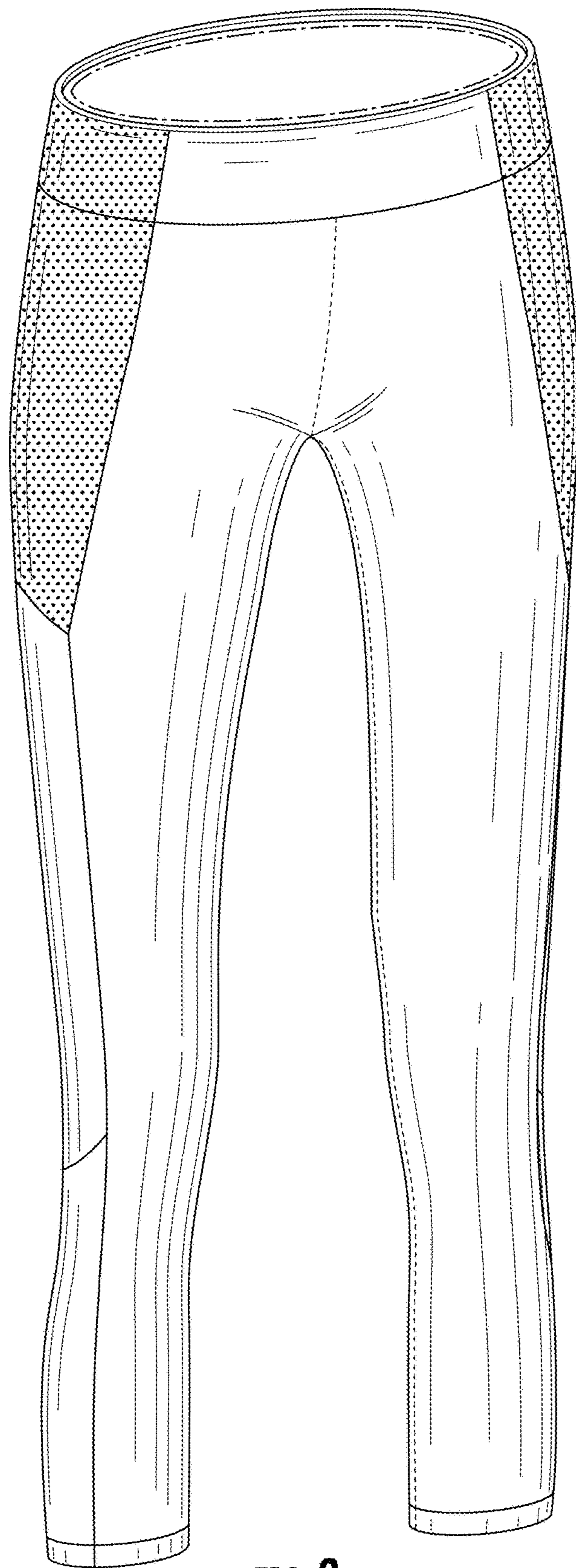


**FIG. 6**



**FIG. 7**





**FIG. 8**

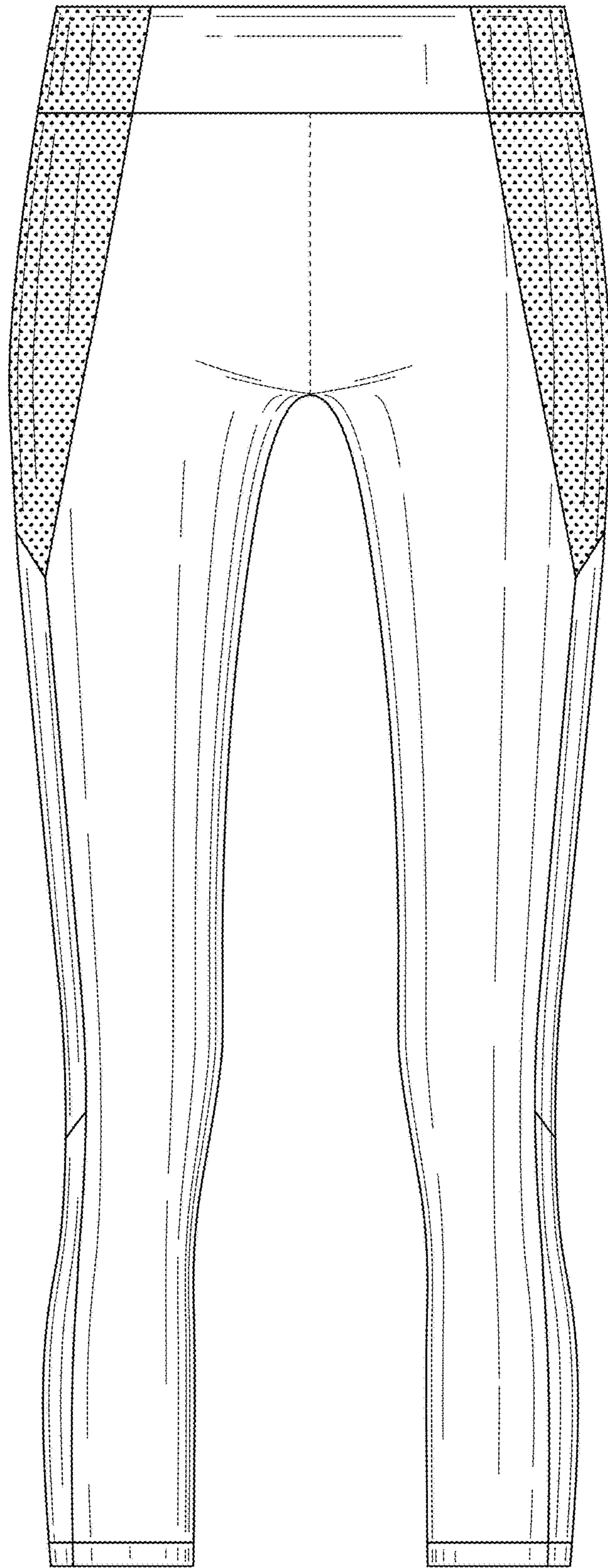
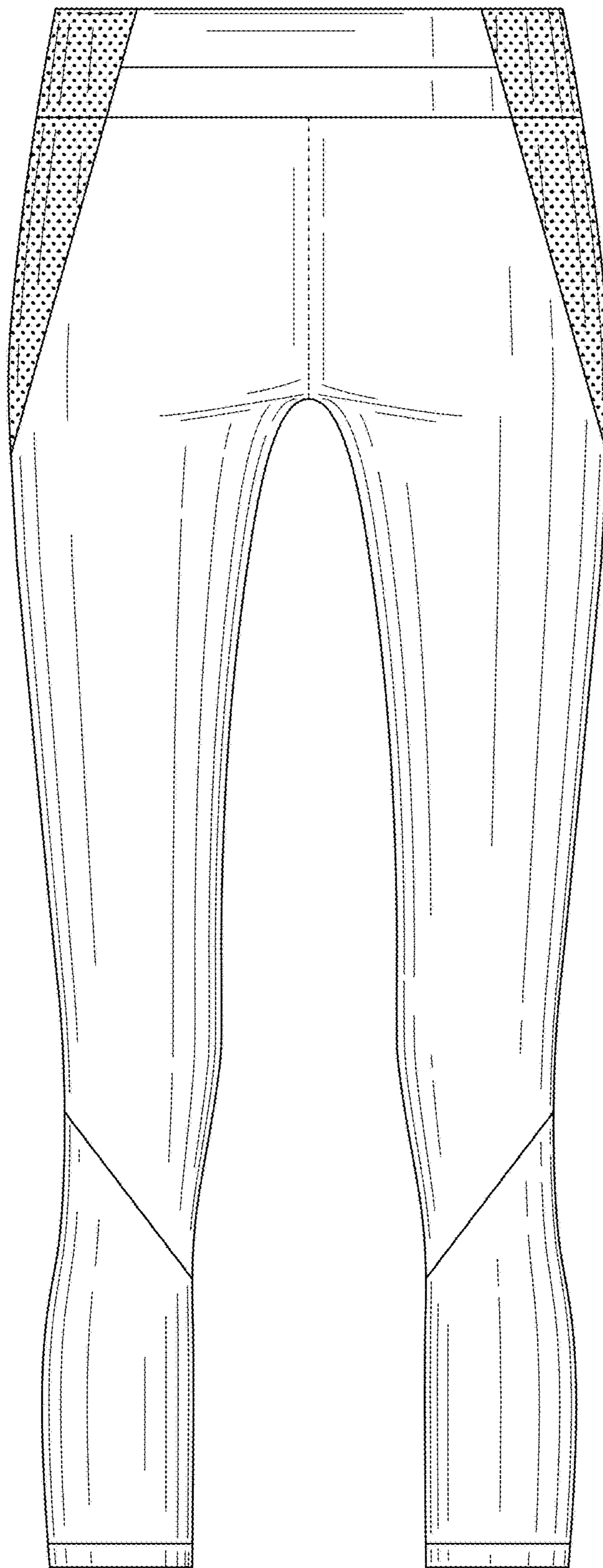
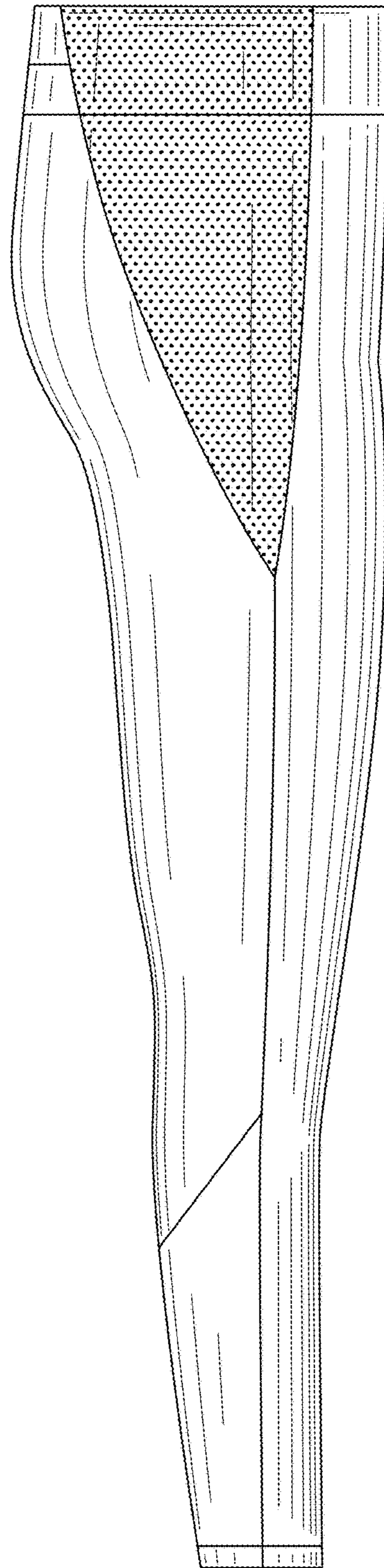


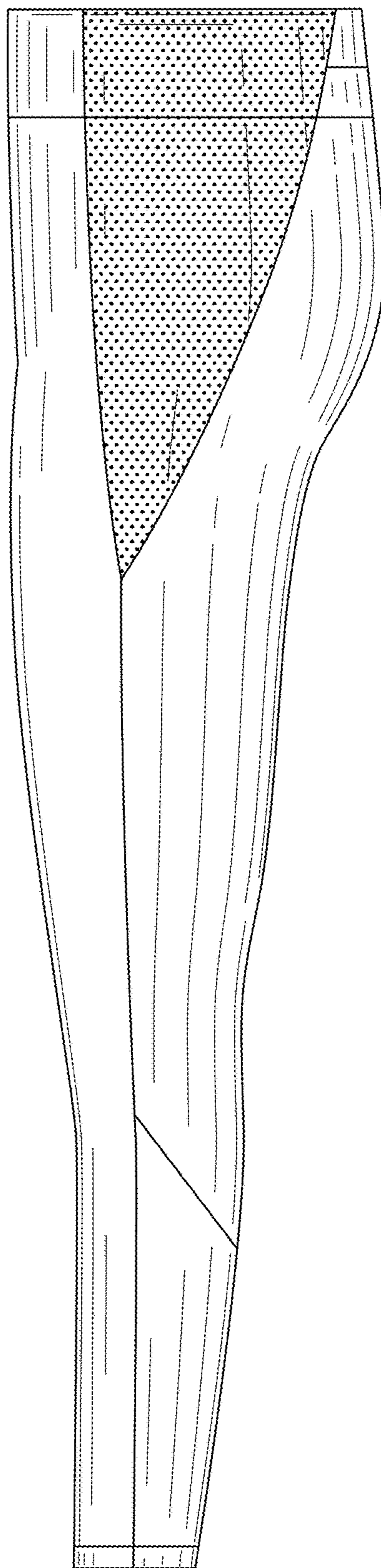
FIG. 9



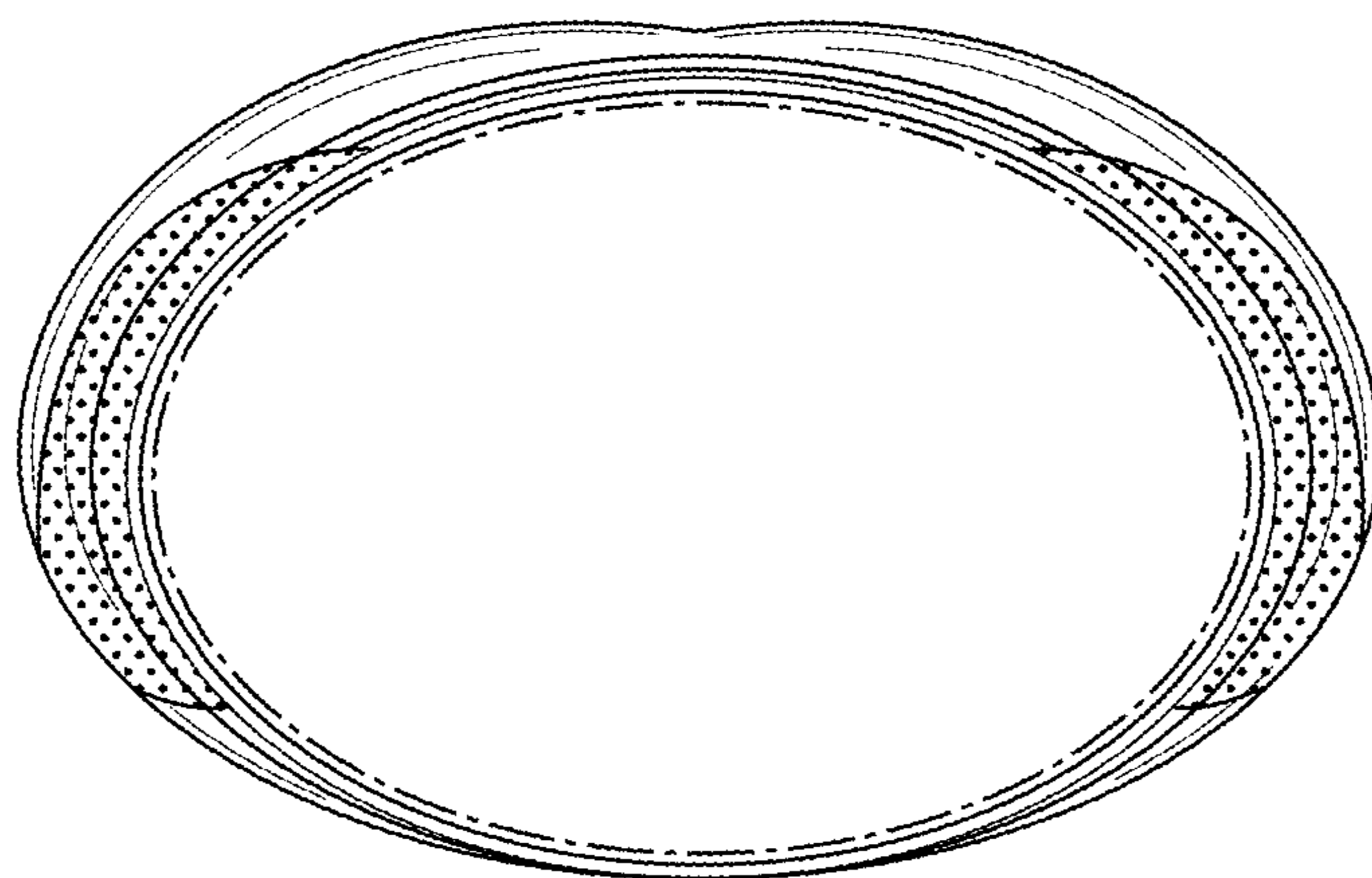
**FIG. 10**



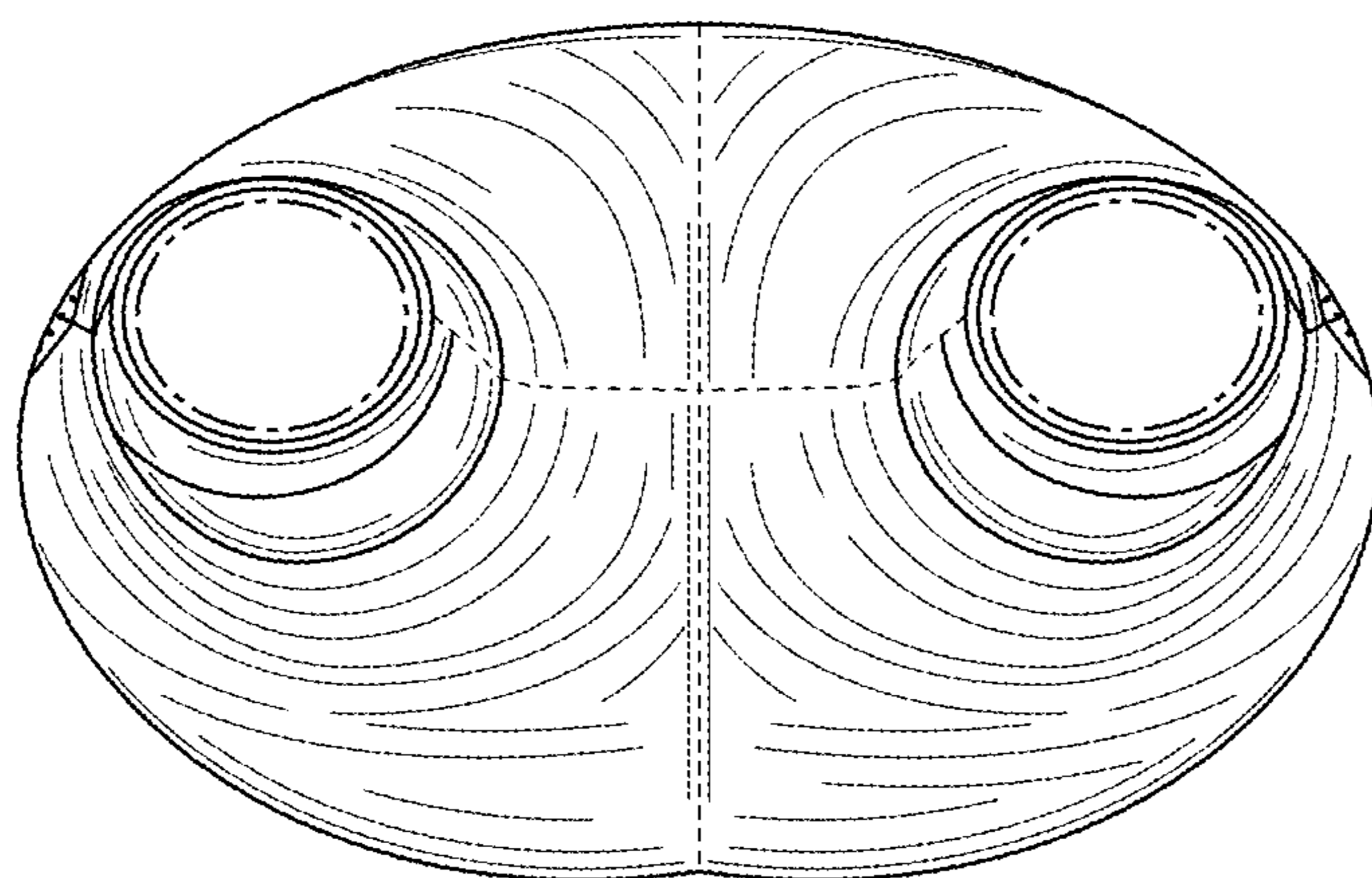
**FIG. 11**



**FIG. 12**



**FIG. 13**



**FIG. 14**