



US00D786258S

(12) **United States Design Patent** (10) **Patent No.:** **US D786,258 S**
Ignomirello (45) **Date of Patent:** **** May 9, 2017**

(54) **FACE PLATE**
(71) Applicant: **Symbolic IO Corporation**, Holmdel, NJ (US)
(72) Inventor: **Brian M. Ignomirello**, Holmdel, NJ (US)
(73) Assignee: **SYMBOLIC IO CORPORATION**, Holmdel, NJ (US)

D357,461 S 4/1995 Zaplatynsky et al.
D366,246 S 1/1996 Simek et al.
D382,880 S 8/1997 Cienkus et al.
D391,938 S 3/1998 D'Agaro et al.
D393,455 S 4/1998 D'Agaro et al.
5,751,549 A 5/1998 Eberhardt et al.
D397,097 S 8/1998 McNally
D409,171 S 5/1999 Wu
D415,747 S * 10/1999 Wu D14/442
(Continued)

(**) Term: **15 Years**

FOREIGN PATENT DOCUMENTS

WO 2010138824 A2 12/2010

(21) Appl. No.: **29/583,364**

OTHER PUBLICATIONS

(22) Filed: **Nov. 4, 2016**

Highly Reliable Systems, "MPac-G2 Media Tray", retrieved on Jul. 14, 2015 from <https://www.high-rely.com/products/mpac-media/>, 1 Page.

(51) **LOC (10) Cl.** **14-02**

Highly Reliable Systems, "RAIDFrame DAS 5000", retrieved on Jul. 14, 2015 from <https://www.high-rely.com/products/raidframe5bay/>, 1 Page.

(52) **U.S. Cl.**

USPC **D14/445**

(Continued)

(58) **Field of Classification Search**

USPC D14/240, 300, 301, 308, 313, 314, D14/348-356, 364-368, 441-446, 188; D13/123, 158, 162, 184, 199; 312/223.1-223.3, 351.11; 360/99.01-99.12; 369/34.01-36.01; 361/679.31-679.33, 679.37, 679.39, 361/679.46, 679.53, 679.4, 679.41, 727
CPC . G06F 1/20; G06F 1/181; G06F 1/187; G06F 1/183; G06F 1/184; G06F 1/16; H05K 7/16; H05K 7/20; H05K 7/1424; H05K 7/1409; H05K 7/20545; H05K 7/20727; H05K 7/1425; H05K 7/1488; H05K 7/183; H05K 7/14; H05K 5/00; H05K 7/00; G11B 33/126; G11B 33/128; G11B 33/08; G11B 33/02

See application file for complete search history.

Primary Examiner — Freda S Nunn
(74) *Attorney, Agent, or Firm* — Maldjian Law Group LLC

(57) **CLAIM**

The ornamental design for a face plate, as shown and described.

DESCRIPTION

FIG. 1 is a front elevational view of a face plate showing my new design;
FIG. 2 is a right side elevational view thereof;
FIG. 3 is a left side elevational view thereof;
FIG. 4 is a rear elevational view thereof;
FIG. 5 is a top plan view thereof;
FIG. 6 is a bottom plan view thereof;
FIG. 7 is a top, right and front side perspective view thereof; and,
FIG. 8 is a rear perspective view thereof.

(56) **References Cited**

U.S. PATENT DOCUMENTS

4,625,710 A 12/1986 Harada et al.
D308,671 S 6/1990 Aderman et al.
4,931,340 A 6/1990 Baba et al.
5,168,171 A 12/1992 Tracewell

1 Claim, 8 Drawing Sheets

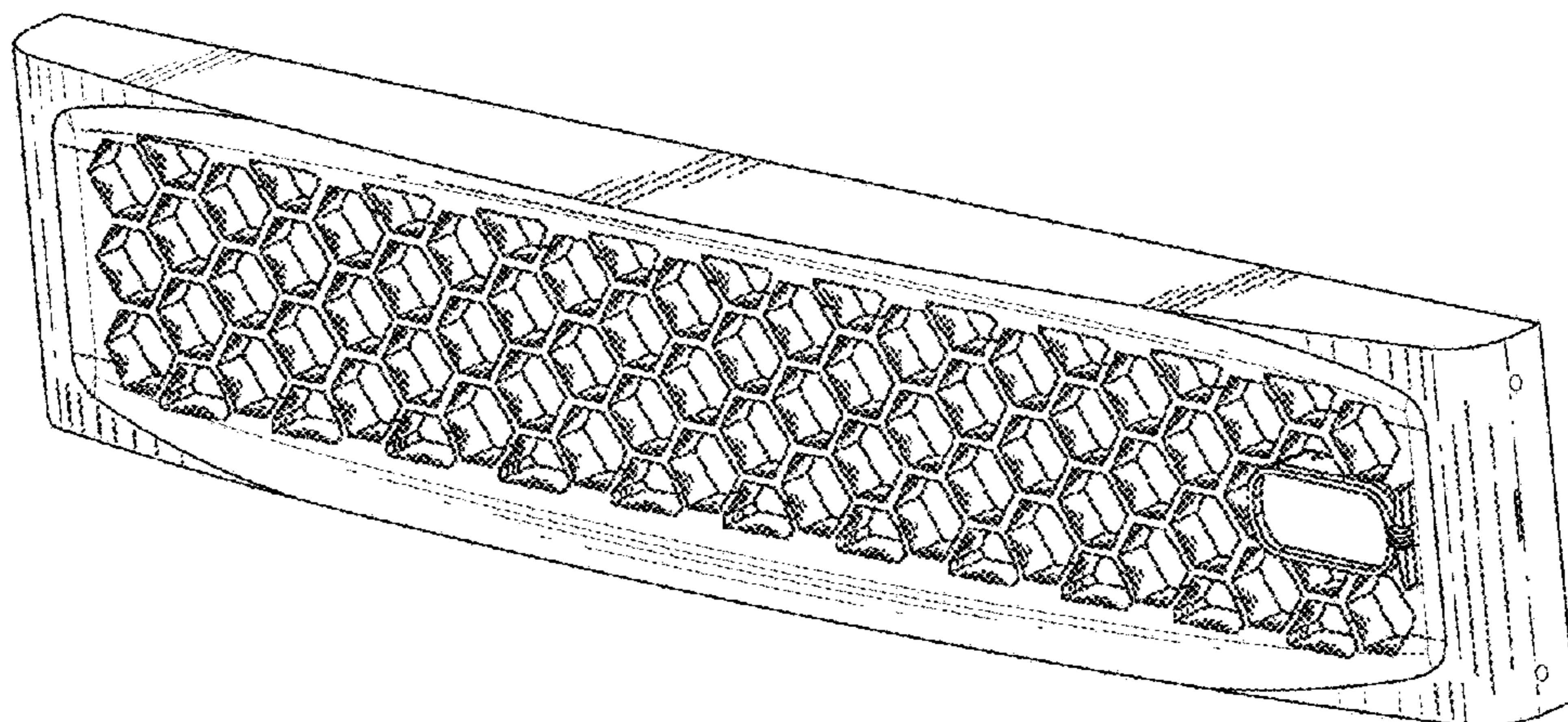

(56)

References Cited

U.S. PATENT DOCUMENTS

D421,428 S	3/2000	Wu	
D431,241 S *	9/2000	Armstrong	D14/348
D439,566 S	3/2001	Ohanian	
D447,484 S	9/2001	Reznikov et al.	
6,373,695 B1	4/2002	Cheng	
D462,075 S	8/2002	Hillyard et al.	
6,494,780 B1	12/2002	Norbury	
D490,083 S	5/2004	Wu	
6,999,319 B2	2/2006	Wu et al.	
D529,915 S	10/2006	Scicluna et al.	
D535,298 S	1/2007	Cochrane	
D555,159 S	11/2007	Cox et al.	
D565,573 S	4/2008	Alo et al.	
D579,455 S	10/2008	Chu	
7,492,607 B2	2/2009	Nguyen et al.	
7,515,413 B1	4/2009	Curtis	
D619,108 S	7/2010	Lin	
D643,434 S *	8/2011	Grady, IV	D14/442
D646,954 S	10/2011	Azelton et al.	
D659,653 S	5/2012	Lin	
D662,501 S	6/2012	Lohman	
D662,504 S	6/2012	Lohman	
D663,299 S *	7/2012	Corke	D14/313
8,238,091 B2 *	8/2012	Chang	G06F 1/187 361/679.33
D676,039 S *	2/2013	Wallace	D14/313
D676,852 S	2/2013	Lohman	
D702,650 S	4/2014	Reed et al.	
D722,060 S *	2/2015	Kwon	D14/445
8,964,385 B2	2/2015	Lam et al.	
8,988,821 B2 *	3/2015	Li	G06F 1/181 360/99.15
D730,307 S	5/2015	Tang et al.	
2004/0017651 A1	1/2004	Gan et al.	
2012/0285738 A1	11/2012	Cochrane et al.	

OTHER PUBLICATIONS

Cisco, "Cisco HDT Network Storage Hard Drive Trays Cisco Small Business Network Storage Systems", Data Sheet, retrieved on Jul. 14, 2015 from http://www.cisco.com/c/en/us/products/collateral/storage-networking/hdt-network-storage-hard-drive-trays/data_sheet_c78-502733.pdf, 3 Pages.

Cclonline, "Cougar MX300 Gamer Case, ATX, No PSU, Max 7 Fans, 7 PCI Cards, USB 3.0, Honeycomb Front", retrieved on Jul. 14, 2015 from <http://www.cclonline.com/product/167472/MX300/Cases/COUGAR-MX300-Gamer-Case-ATX-No-PSU-Max-7-Fans-7-PCI-Cards-USB-3-0-Honeycomb-Front/CAS1679/>, 2 Pages.

Cisco, "Replacing the Cisco 3745 Faceplate/Fan Tray", manual, retrieved on Jul. 14, 2015 from http://www.cisco.com/public/scc/compass/3700/tasks/task_3745_faceplate_replace.htm, 1 Page.

Cisco, "Cisco Catalyst 4948 10 Gigabit Ethernet Switch Data Sheet", Data Sheet, retrieved on Jul. 14, 2015 from http://www.cisco.com/c/en/us/products/collateral/switches/catalyst-4900-series-switches/product_data_sheet0900aecd80246552.html, 15 Pages.

Cisco, "Replacing Cisco ASR 9000 Series Router Components", manual, retrieved on Jul. 14, 2015 from <http://www.cisco.com/c/en/us/td/docs/routers/asr9000/hardware/installation/guide/asr9kHIGbk/asr9klGmaintaining.html>, 15 Pages.

Frostytech, "Copper Honeycomb Concept Heatsink—BBHS Thermal Solutions Corp", retrieved on Jul. 14, 2015 from <http://www.frostytech.com/permalinkArch.cfm?NewsID=88219>, 1 Page.

Aliexpress, "F238F 3.5" Hot-Swap SAS/SATA Hard Disk Drive Caddy /Tray", retrieved on Jul. 14, 2015 from http://www.aliexpress.com/store/product/F238F-3-5-Hot-Swap-SAS-SATA-Hard-Disk-Drive-Caddy-Tray/1129178_1677183967.html, 1 Page.

McCabe, "How to Add a Hard Drive to Your Windows Home Server", InformationWeek Network Computing, retrieved on Jul. 14, 2015 from <http://www.networkcomputing.com/storage/how-to-add-a-hard-drive-to-your-windows-home-server-/d/d-id/1098397?>, 3 Pages.

* cited by examiner

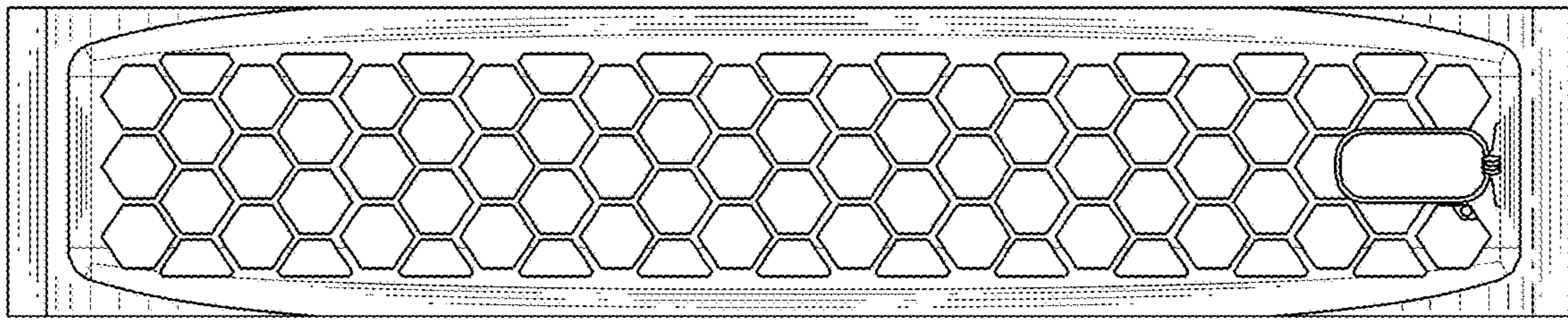

FIG. 1

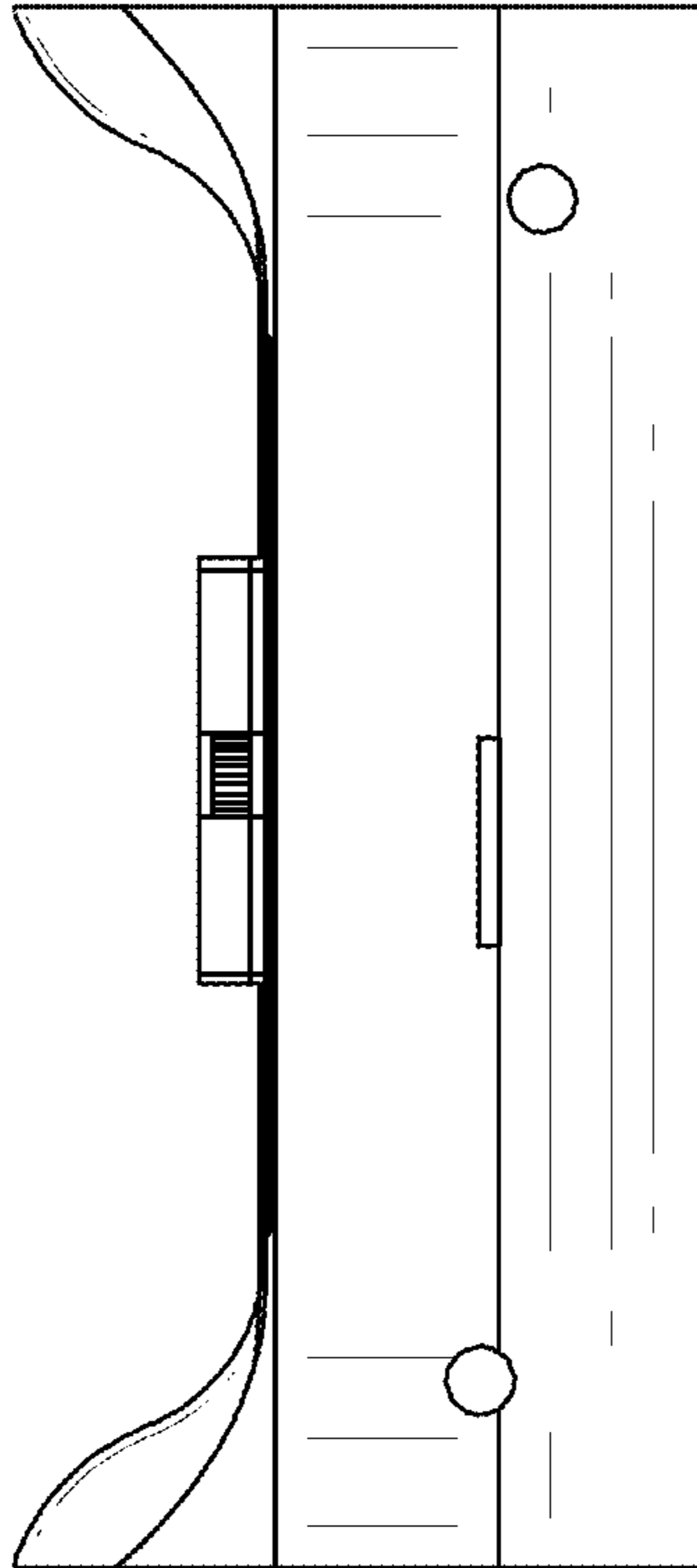

FIG. 2

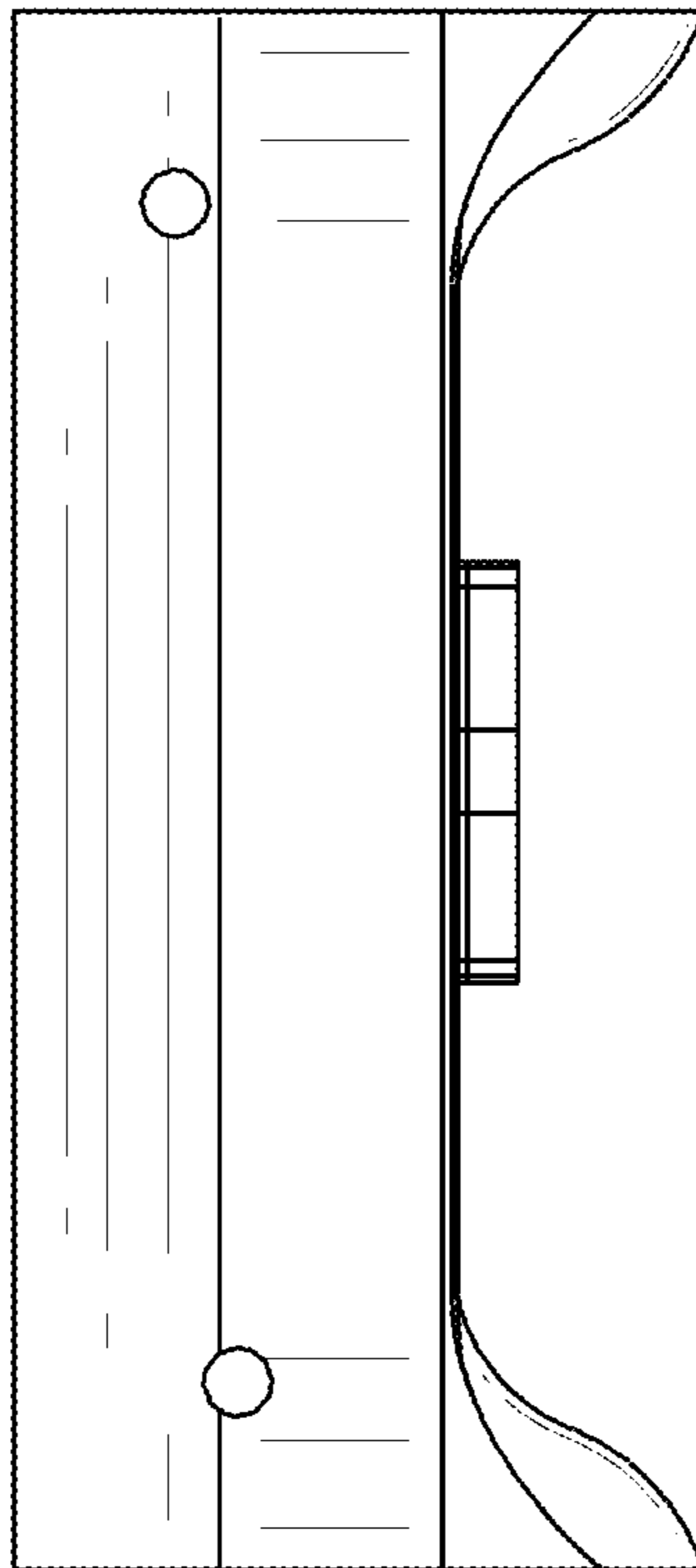

FIG. 3

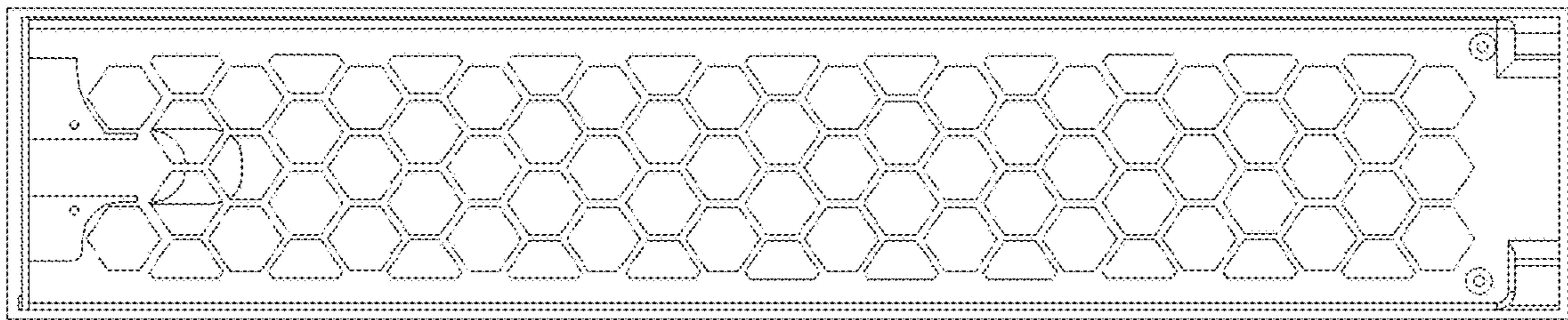

FIG. 4

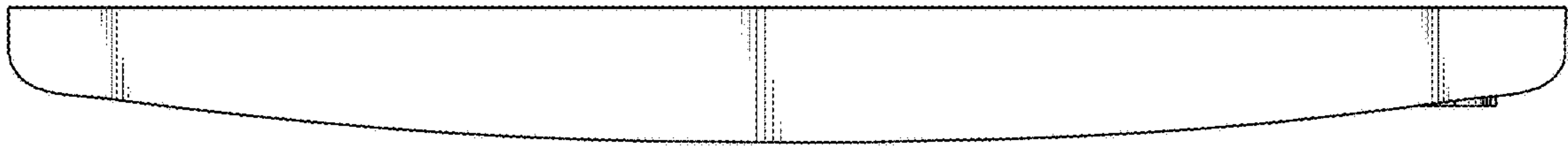

FIG. 5

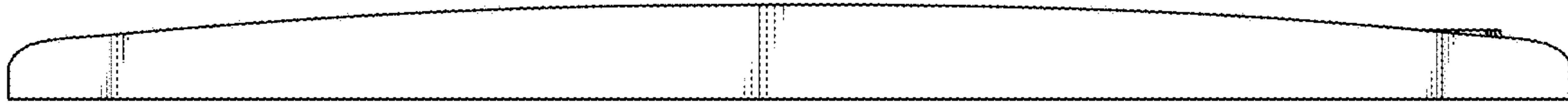

FIG. 6

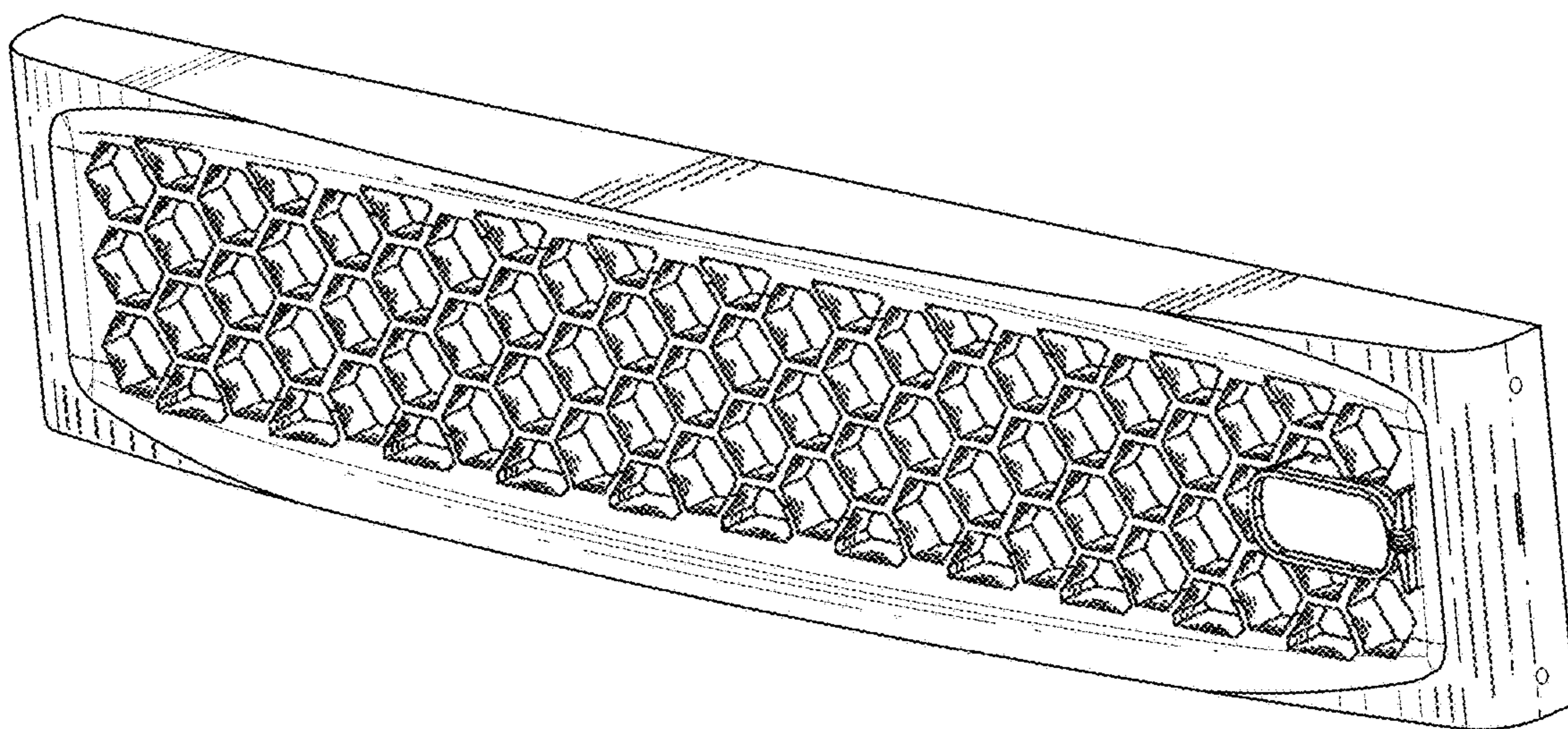

FIG. 7

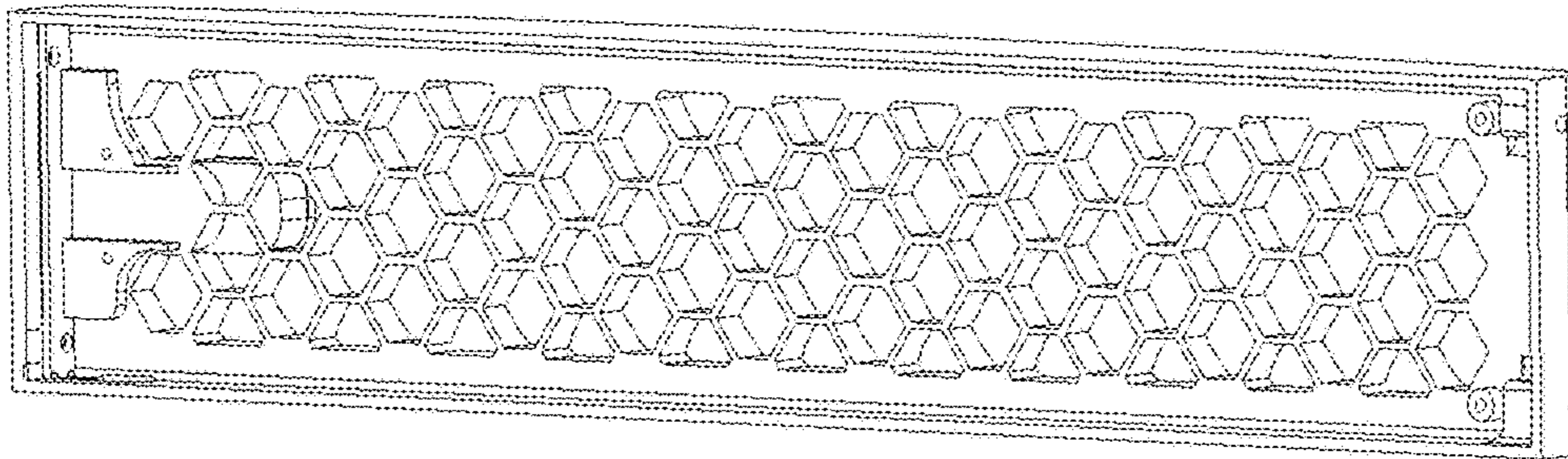

FIG. 8