



US00D786229S

(12) **United States Design Patent**  
**Kim et al.**

(10) **Patent No.:** **US D786,229 S**

(45) **Date of Patent:** **\*\* May 9, 2017**

(54) **MOBILE PHONE**

(71) Applicant: **LG ELECTRONICS INC.**, Seoul (KR)

(72) Inventors: **Dami Kim**, Seoul (KR); **Byeongwook Kim**, Seoul (KR); **Youngho Kim**, Seoul (KR)

(73) Assignee: **LG Electronics Inc.**, Seoul (KR)

(\*\*) Term: **15 Years**

(21) Appl. No.: **29/543,270**

(22) Filed: **Oct. 22, 2015**

(30) **Foreign Application Priority Data**

Apr. 23, 2015 (KR) ..... 30-2015-0020785

(51) **LOC (10) Cl.** ..... **14-03**

(52) **U.S. Cl.**  
USPC ..... **D14/248**

(58) **Field of Classification Search**

USPC ..... D14/138 G, 138 AD, 248, 138 R,  
D14/138 AC, 247, 137, 341-347

CPC ..... H04M 1/0202; H04M 1/0235; H04M  
1/0237; H04M 1/0239; H04M 1/0266;  
H04M 1/0268; H04M 1/027; H04M  
1/0295

See application file for complete search history.

(56) **References Cited**

**U.S. PATENT DOCUMENTS**

- D568,286 S \* 5/2008 Suk ..... D14/138 G
- D637,996 S \* 5/2011 Kim ..... D14/203.3
- D687,405 S \* 8/2013 Takei ..... D14/138 G
- D699,207 S \* 2/2014 Kim ..... D14/138 G
- D713,812 S \* 9/2014 Hachiya ..... D14/138 G
- D719,124 S \* 12/2014 Kim ..... D14/138 AD
- D723,496 S \* 3/2015 Ryu ..... D14/138 G
- D728,506 S \* 5/2015 Joung ..... D14/138 G
- D732,500 S \* 6/2015 Choe ..... D14/138 G

- D736,753 S \* 8/2015 Kang ..... D14/248
- D739,371 S \* 9/2015 Seo ..... D14/138 G
- D740,776 S \* 10/2015 Kim ..... D14/138 AD
- D741,832 S \* 10/2015 Lee ..... D14/138 G
- D749,536 S \* 2/2016 Hachiya ..... D14/138 G
- D753,623 S \* 4/2016 Park ..... D14/138 G
- D756,323 S \* 5/2016 Seo ..... D14/138 G

(Continued)

**OTHER PUBLICATIONS**

LG Magna, announced Feb. 2015, [online], [retrieved on Jan. 28, 2016]. Retrieved from Internet ,<URL: <http://www.gsmarena.com>>.\*

(Continued)

*Primary Examiner* — Bridget L Eland

(74) *Attorney, Agent, or Firm* — Birch, Stewart, Kolasch & Birch, LLP

(57) **CLAIM**

The ornamental design for a mobile phone, as shown and described.

**DESCRIPTION**

FIG. 1 is a front perspective view of a mobile phone showing our new design;  
FIG. 2 is a front view thereof;  
FIG. 3 is a rear view thereof;  
FIG. 4 is a left side view thereof;  
FIG. 5 is a right side view thereof;  
FIG. 6 is a top plan view thereof;  
FIG. 7 is a bottom plan view thereof; and,  
FIG. 8 is a rear perspective view thereof.

The dash-dot broken lines and evenly spaced broken lines that are immediately adjacent to the claim, encompassing unshaded regions, represent the bounds of the claim, while all other evenly spaced broken lines are directed to environment; the broken lines form no part of the claimed design.

**1 Claim, 7 Drawing Sheets**

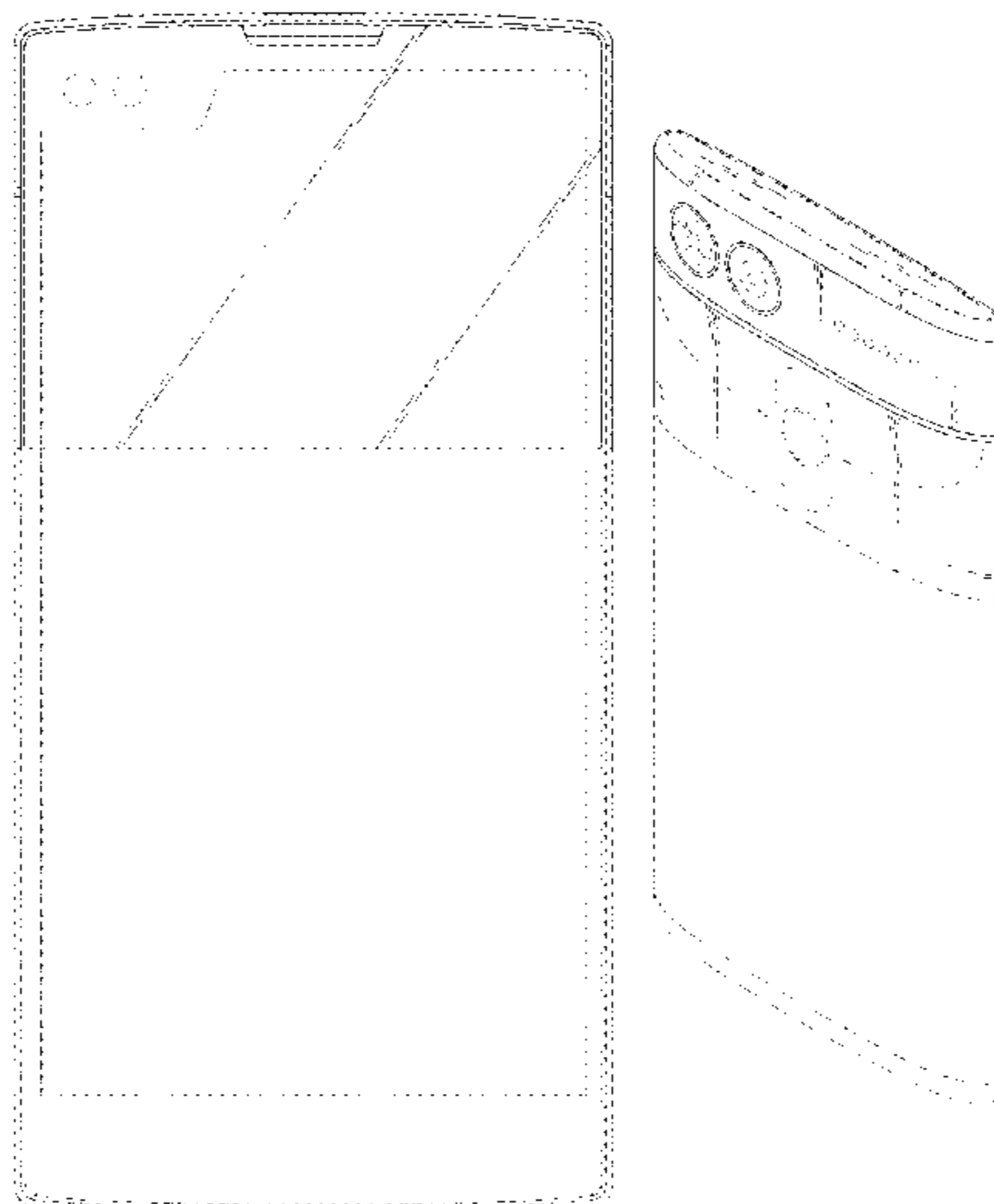

(56)

**References Cited**

U.S. PATENT DOCUMENTS

D756,948 S \* 5/2016 Kim ..... D14/138 G  
D756,949 S \* 5/2016 Kim ..... D14/138 G  
D756,950 S \* 5/2016 Kim ..... D14/138 G  
D757,674 S \* 5/2016 Seo ..... D14/138 G  
D758,987 S \* 6/2016 Kim ..... D14/138 AA  
D762,611 S \* 8/2016 Lee ..... D14/138 G  
D763,837 S \* 8/2016 Choe ..... D14/248  
D768,104 S \* 10/2016 Park ..... D14/138 G  
D771,003 S \* 11/2016 Kim ..... D14/138 G  
2010/0048190 A1\* 2/2010 Park ..... H04M 1/57  
455/415

OTHER PUBLICATIONS

LG G4c, announced May 2015, [online], [retrieved on Nov. 11, 2016]. Retrieved from Internet ,<URL: <http://www.gsmarena.com>>.\*

Acer neoTouch, announced Oct. 2009, [online], [retrieved on Oct. 28, 2009]. Retrieved from Internet ,<URL: <http://www.gsmarena.com>>.\*

LG G Pad II 8.3 LTE, announced Dec. 2015, [online], [retrieved on Jan. 28, 2016]. Retrieved from Internet ,<URL: <http://www.gsmarena.com>>.\*

\* cited by examiner

FIG. 1

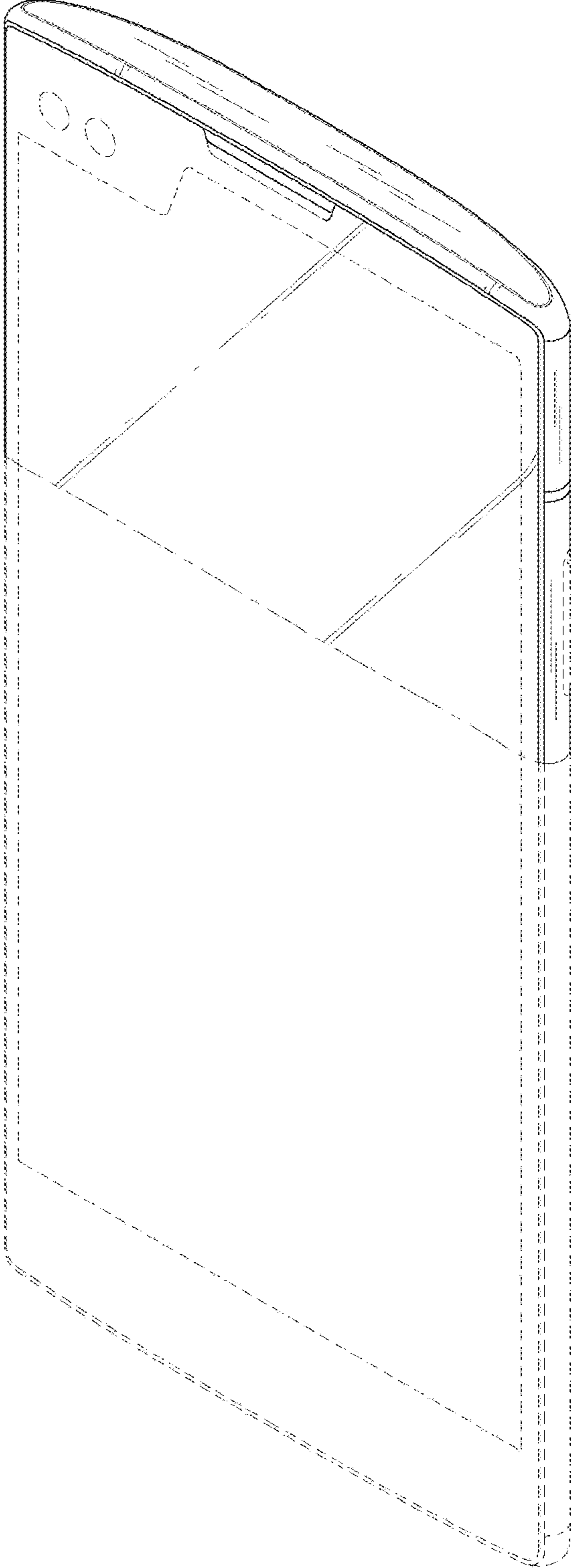

FIG. 2

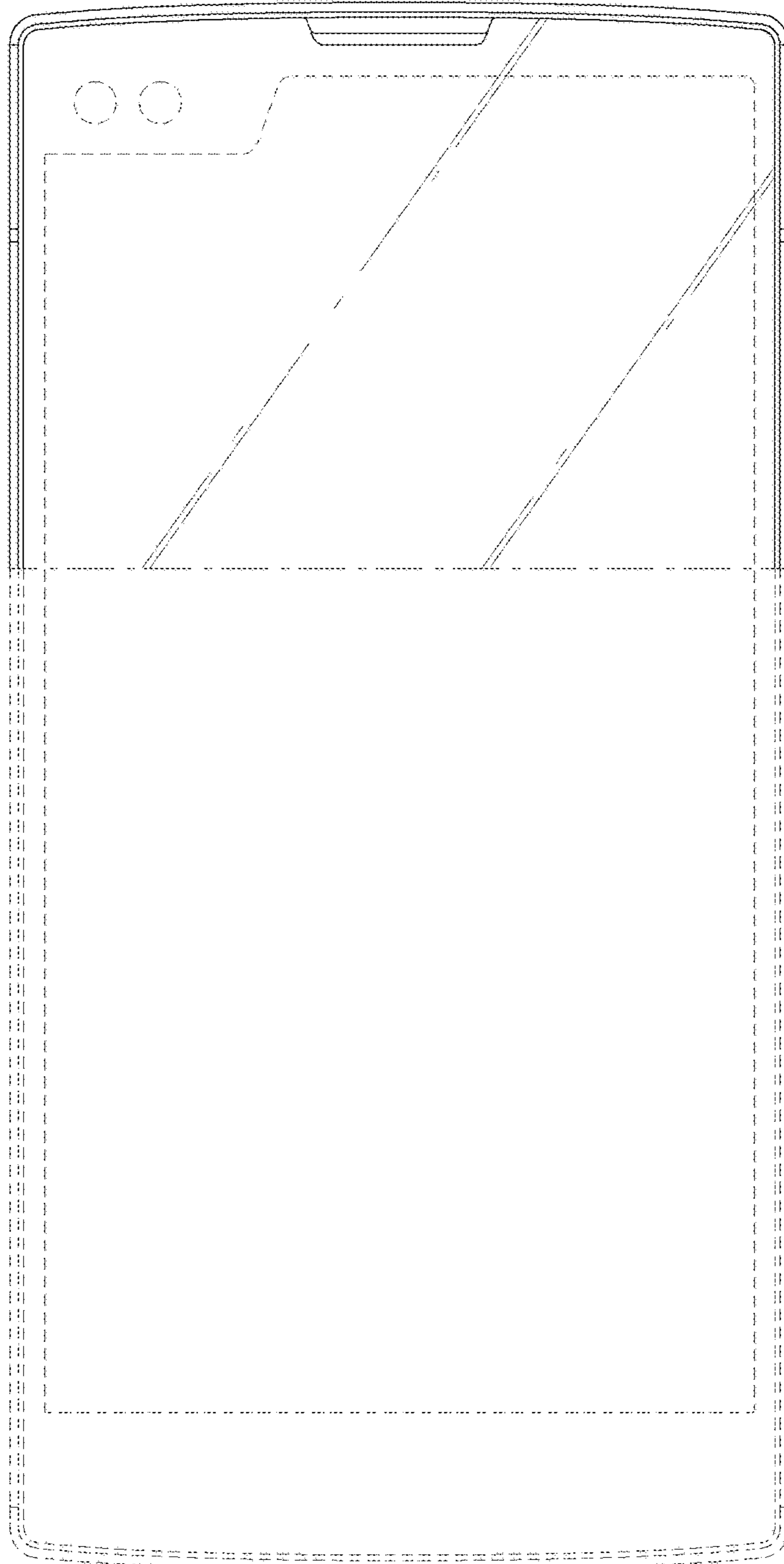

FIG. 3

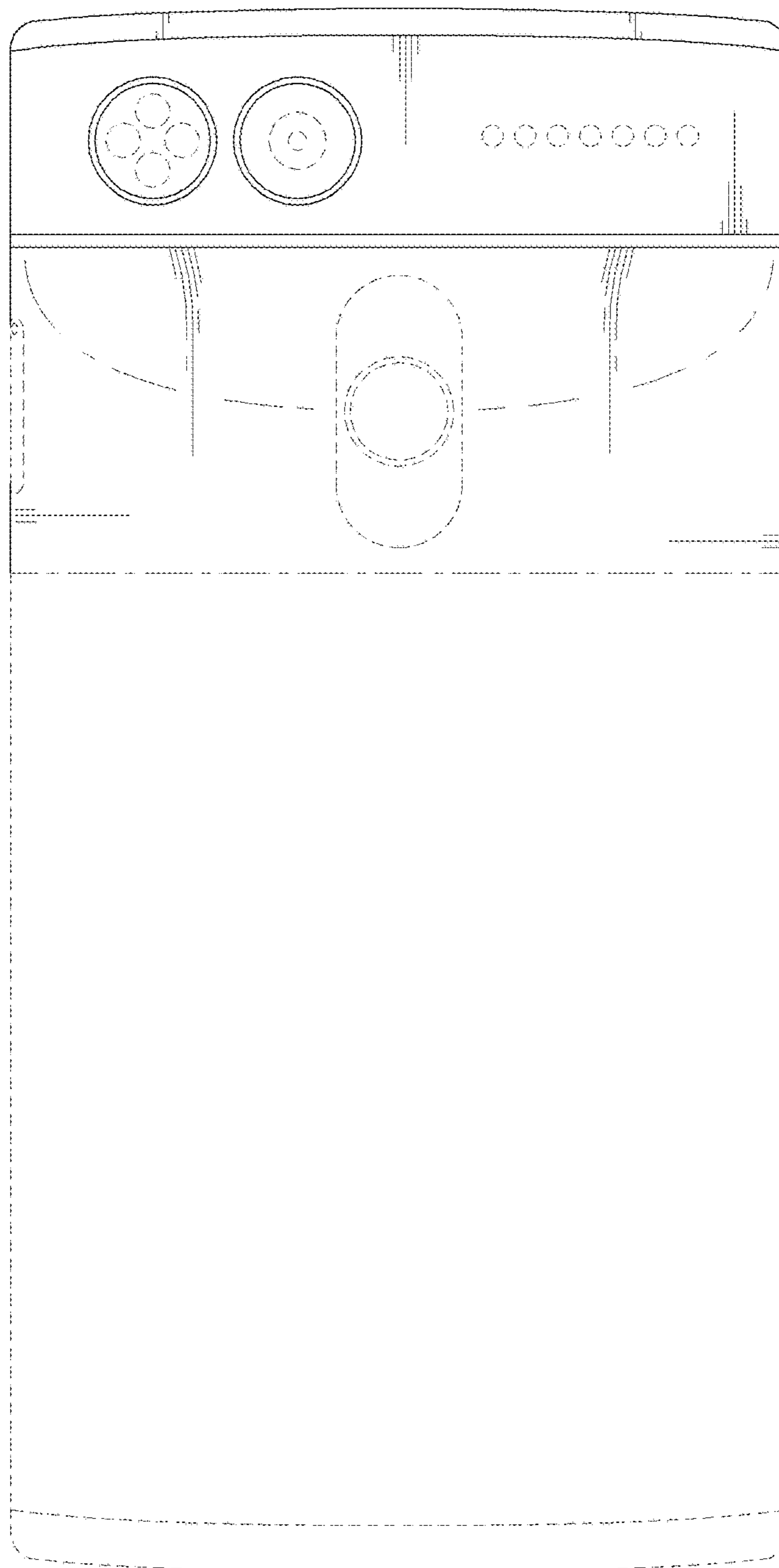

FIG. 4

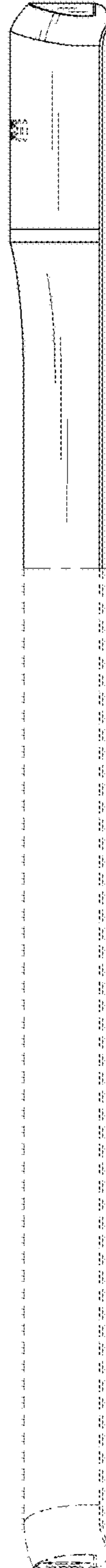

FIG. 5

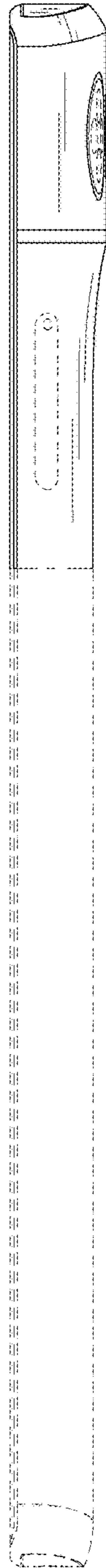

FIG. 6

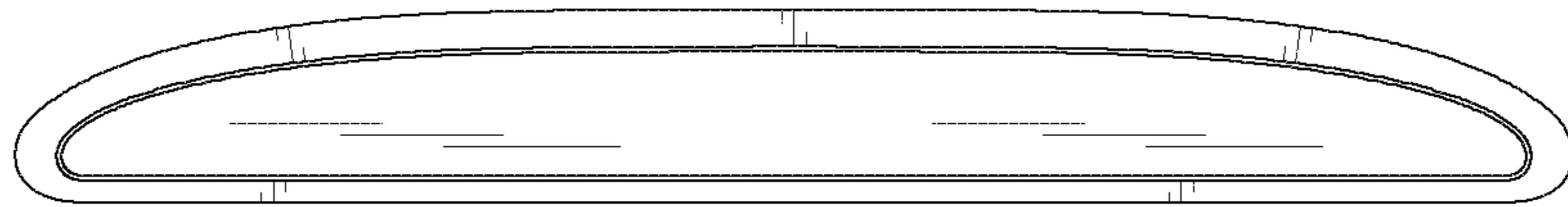

FIG. 7

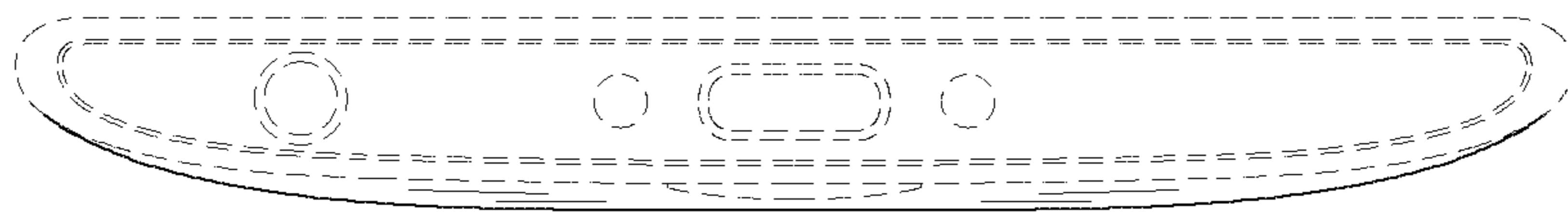



FIG. 8

