



US00D786227S

(12) **United States Design Patent** (10) **Patent No.:** **US D786,227 S**
Kim et al. (45) **Date of Patent:** **** May 9, 2017**

(54) **ELECTRONIC DEVICE**

(71) Applicant: **Samsung Electronics Co., Ltd.**,
Suwon-si (KR)

(72) Inventors: **Nam-Su Kim**, Seoul (KR); **Do-Hyung Ha**, Gwangmyeong-si (KR); **Sae-Hee Lee**, Incheon (KR); **Hyun-Sook Kim**, Seoul (KR); **Christine Rhea Oh**, Yongin-si (KR)

(73) Assignee: **SAMSUNG ELECTRONICS CO., LTD.**, Suwon-si (KR)

(**) Term: **14 Years**

(21) Appl. No.: **29/509,253**

(22) Filed: **Nov. 14, 2014**

(51) **LOC (10) Cl.** **14-03**

(52) **U.S. Cl.**
USPC **D14/248**

(58) **Field of Classification Search**
USPC D14/138 G, 138 AD, 138 R, 138 AC,
D14/203.1, 203.3, 203.5, 203.7, 218, 248,
D14/341, 496; D21/329, 331, 517;
D13/168; D10/65, 78; D7/393, 394,
D7/396.6

CPC H04M 1/02; H04M 1/0202; H04M 1/0235;
H04M 1/0237; H04M 1/0239; H04M
1/03; H04M 1/23; H04M 1/72519; H04M
1/72522; H04M 2250/22

See application file for complete search history.

(56) **References Cited**

U.S. PATENT DOCUMENTS

D667,396 S * 9/2012 Koh D14/341
D741,830 S * 10/2015 Lee D14/138 G

(Continued)

OTHER PUBLICATIONS

Samsung Galaxy Note 4 Duos, announced Oct. 2014, [online], [site visited Dec. 16, 2016]. Available from internet, <URL: http://www.gsmarena.com/samsung_galaxy_note_4_duos-6749.php>.*

Primary Examiner — George D Kirschbaum

Assistant Examiner — Joseph Kukella

(74) *Attorney, Agent, or Firm* — McAndrews Held & Malloy, Ltd.

(57) **CLAIM**

The ornamental design for an electronic device, as shown and described.

DESCRIPTION

FIG. 1 is a top right front perspective view of an electronic device showing our new design;

FIG. 2 is a front elevation view thereof;

FIG. 3 is a rear elevation view thereof;

FIG. 4 is a left-side elevation view thereof;

FIG. 5 is a right-side elevation view thereof;

FIG. 6 is a top plan view thereof;

FIG. 7 is a bottom plan view thereof;

FIG. 8 is a bottom left rear perspective view thereof;

FIG. 9 is an enlarged view of the portion A encircled in FIG. 1;

FIG. 10 is an enlarged view of the portion B encircled in FIG. 1;

FIG. 11 is an enlarged view of the portion C encircled in FIG. 2; and,

FIG. 12 is an enlarged view of the portion D encircled in FIG. 3.

The stippled areas represent areas of contrasting color to adjacent non-stippled areas. No particular colors are being claimed.

The dashed broken lines are for environmental purposes only and form no part of the claimed design.

The dot-dash broken lines in the figures represent an unclaimed boundary line and form no part of the claimed design.

The dot-dot-dash broken lines encircle portions of the claimed design that are illustrated in enlargements.

1 Claim, 8 Drawing Sheets

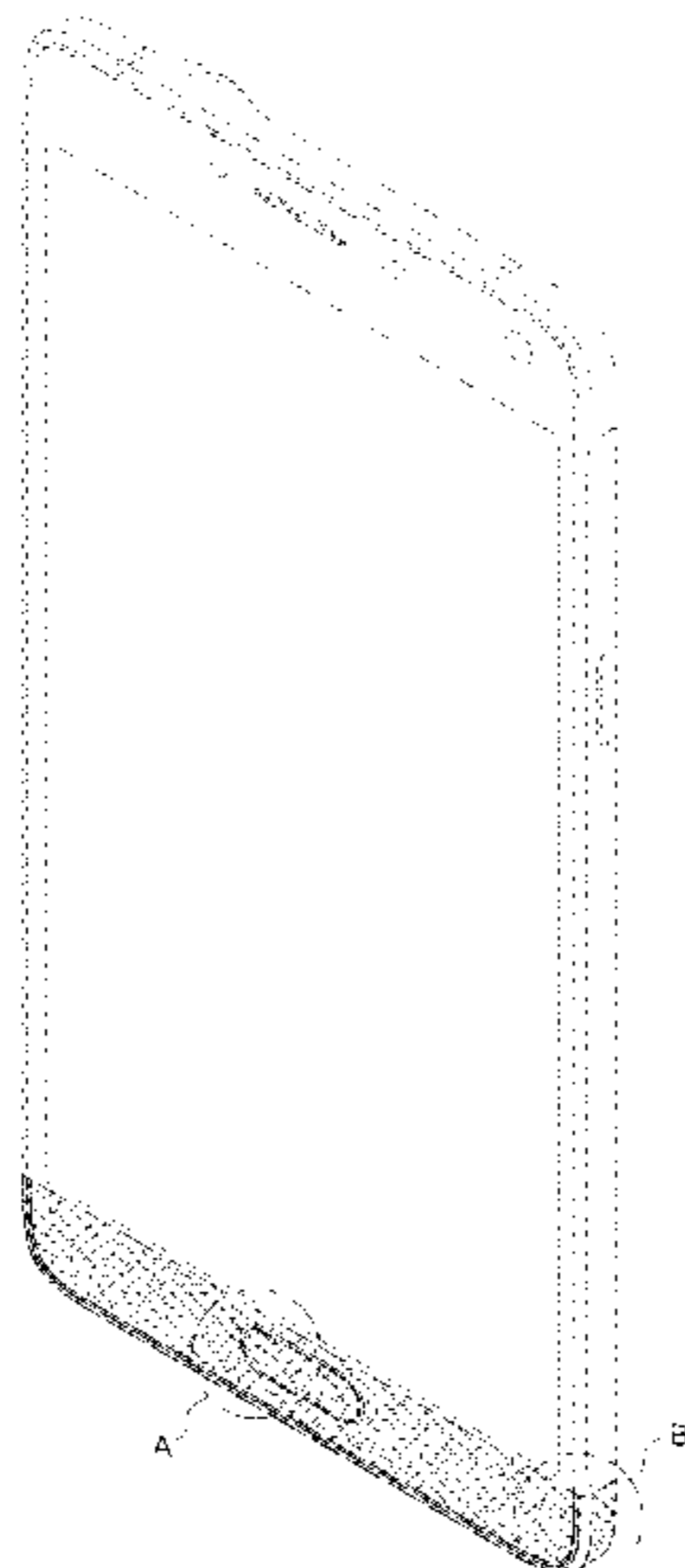

(56)

References Cited

U.S. PATENT DOCUMENTS

D763,846 S	*	8/2016	Lee	D14/341
D768,102 S	*	10/2016	Lee	D14/138 G
D770,408 S	*	11/2016	Lee	D14/138 G
D770,431 S	*	11/2016	Lee	D14/248
D770,432 S	*	11/2016	Lee	D14/248

* cited by examiner

FIG. 1

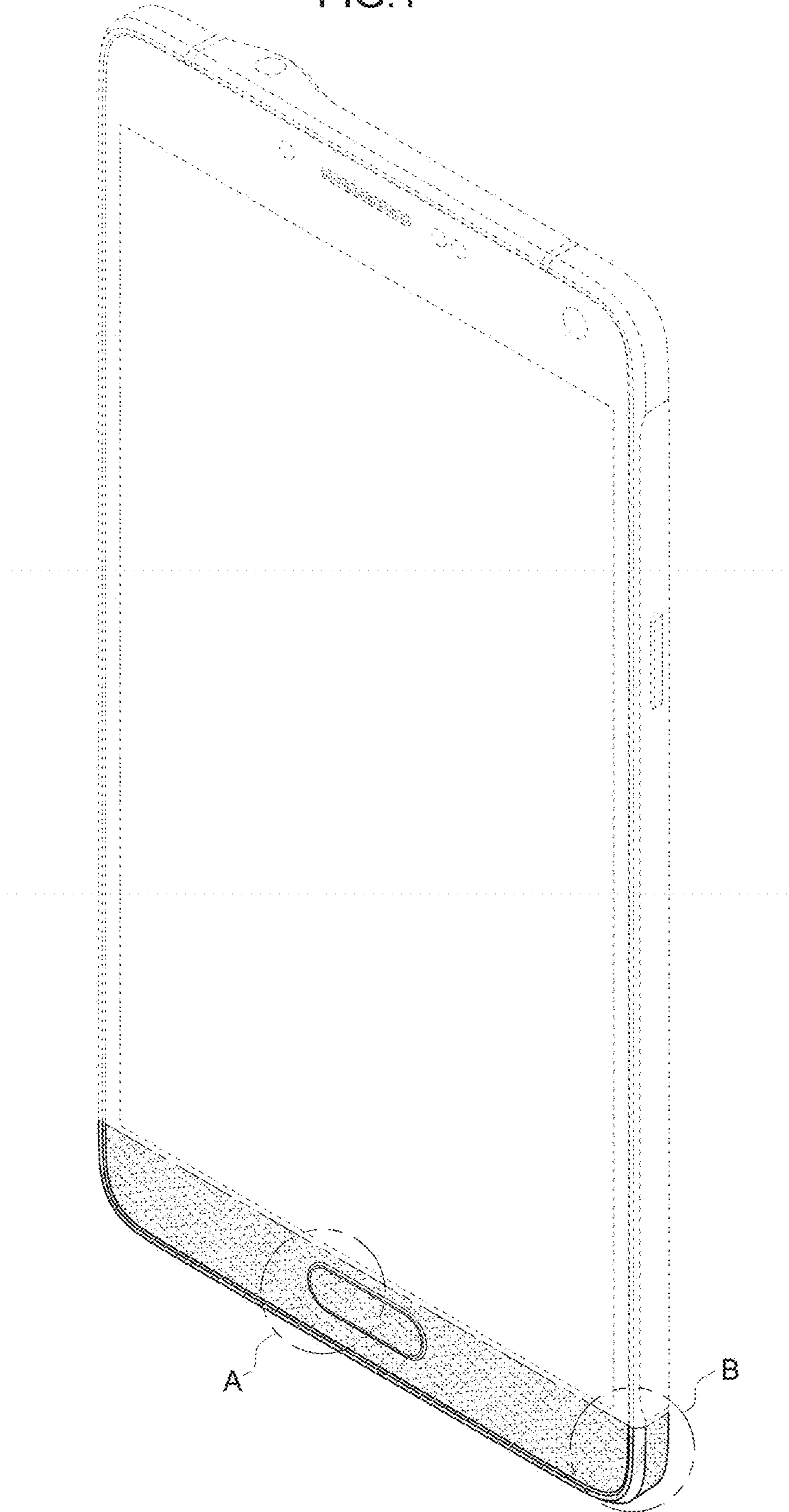

FIG.2

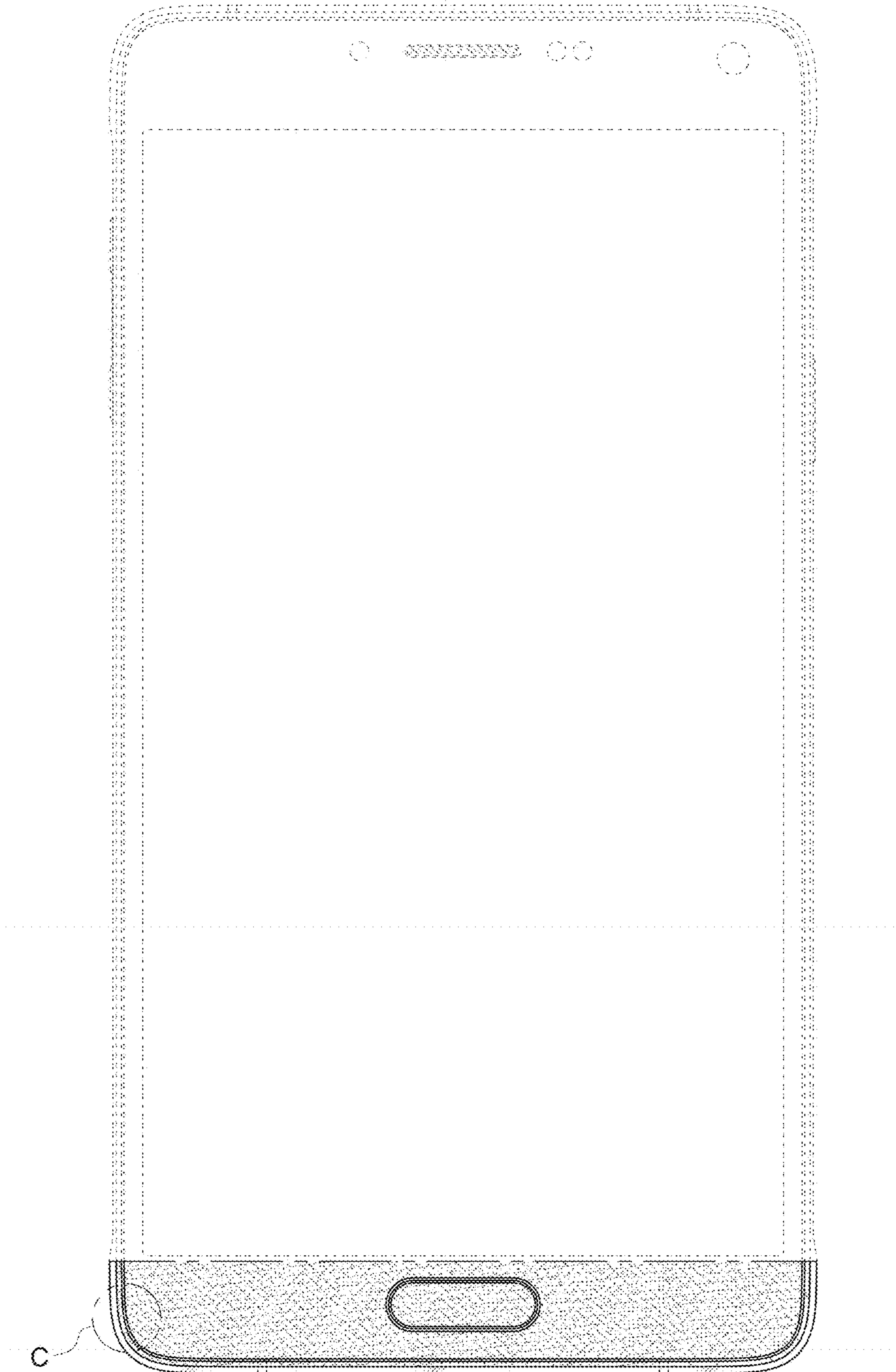

FIG.3

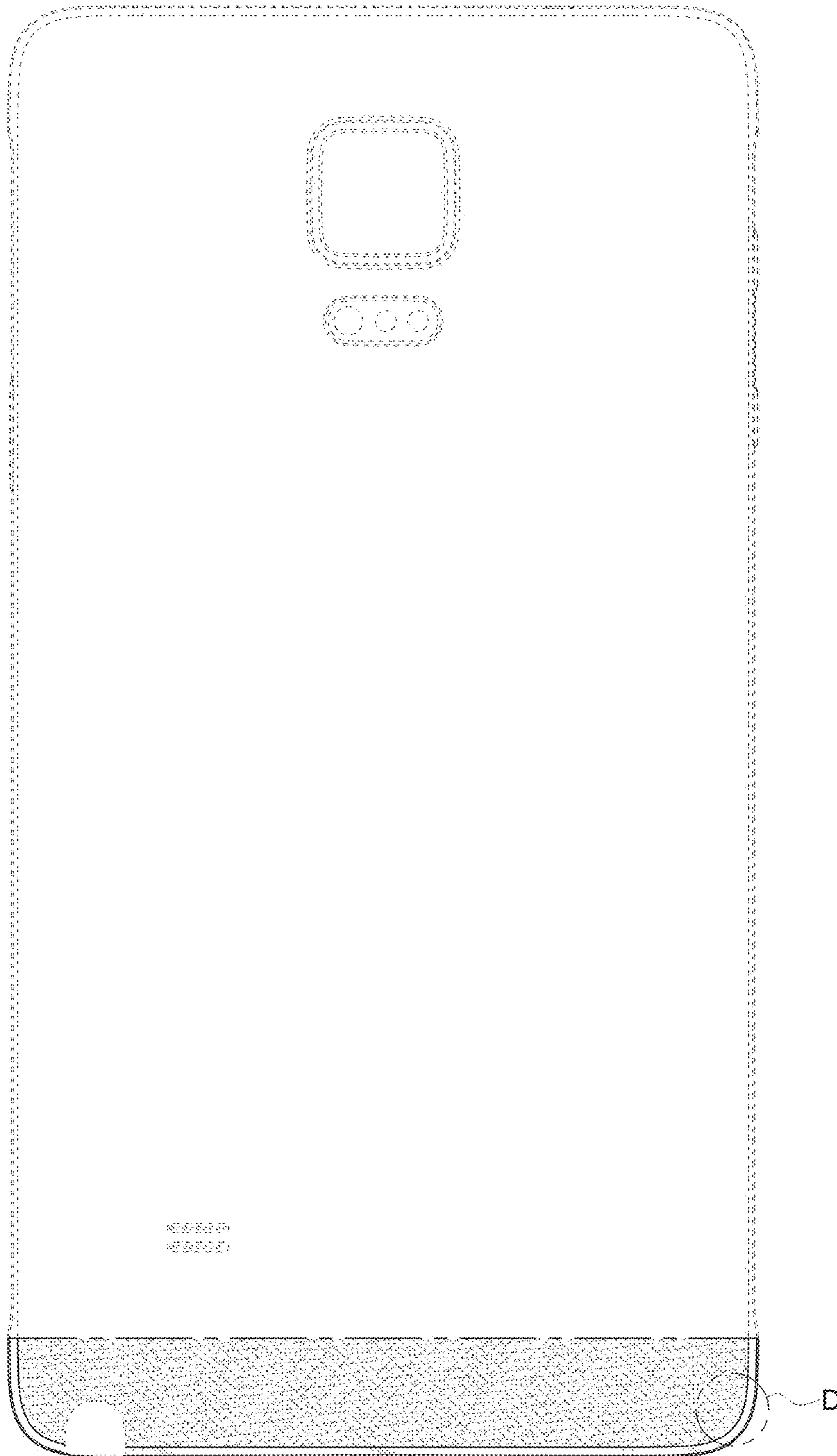

FIG.4

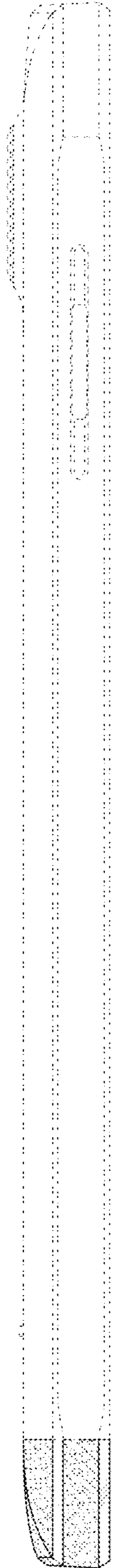

FIG.5

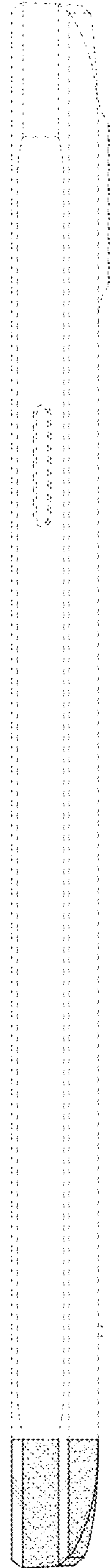

FIG.6

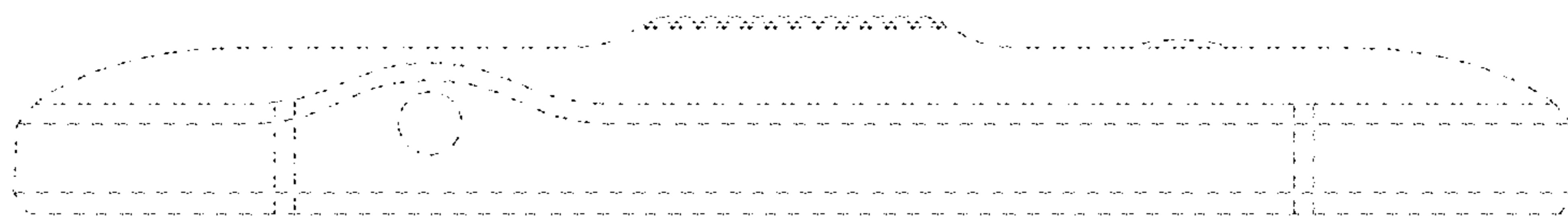

FIG.7

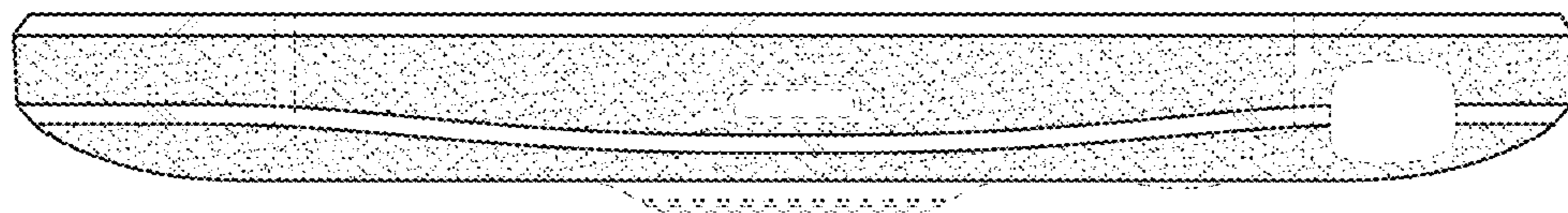

FIG.8



FIG.9

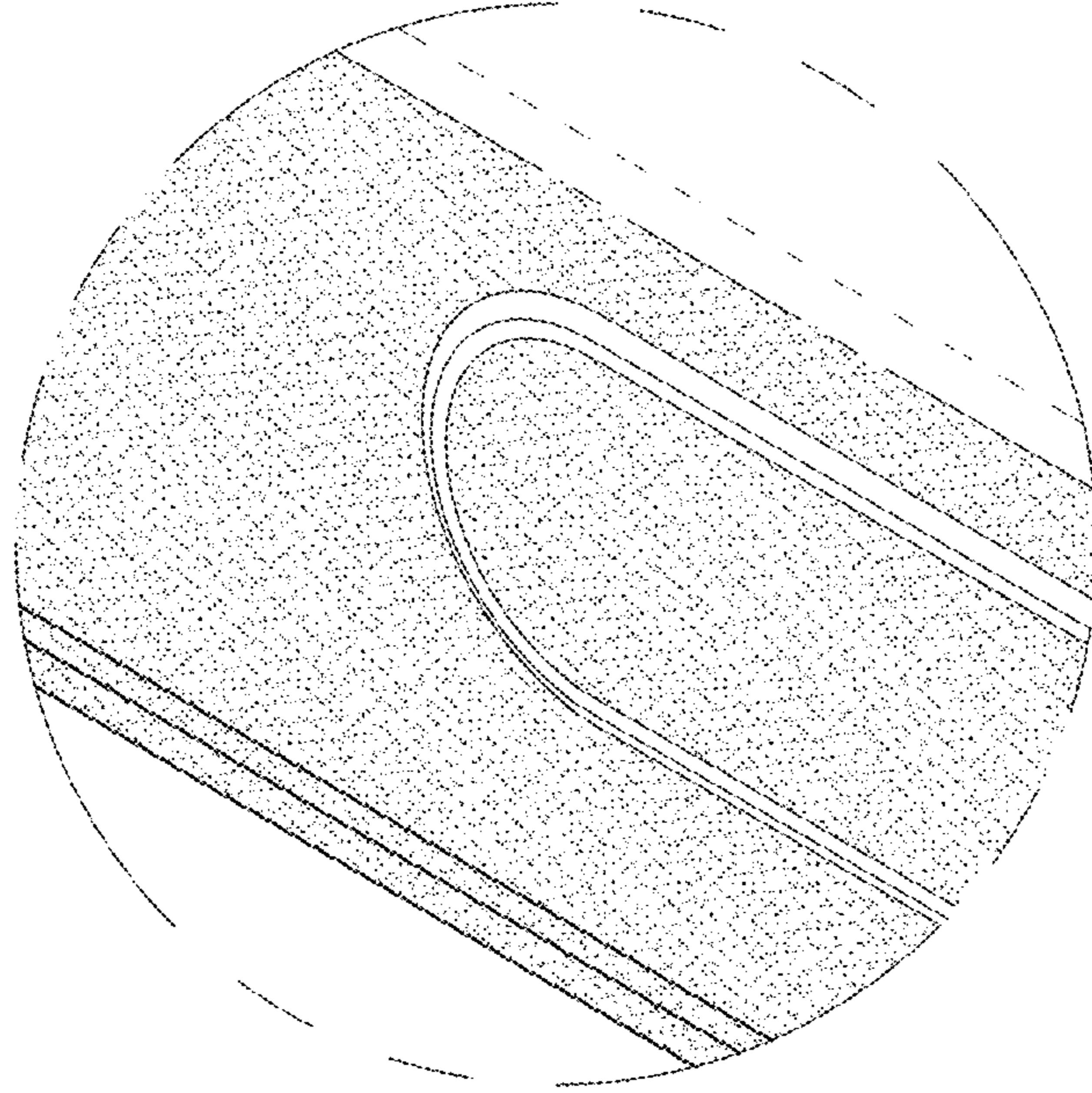

FIG.10

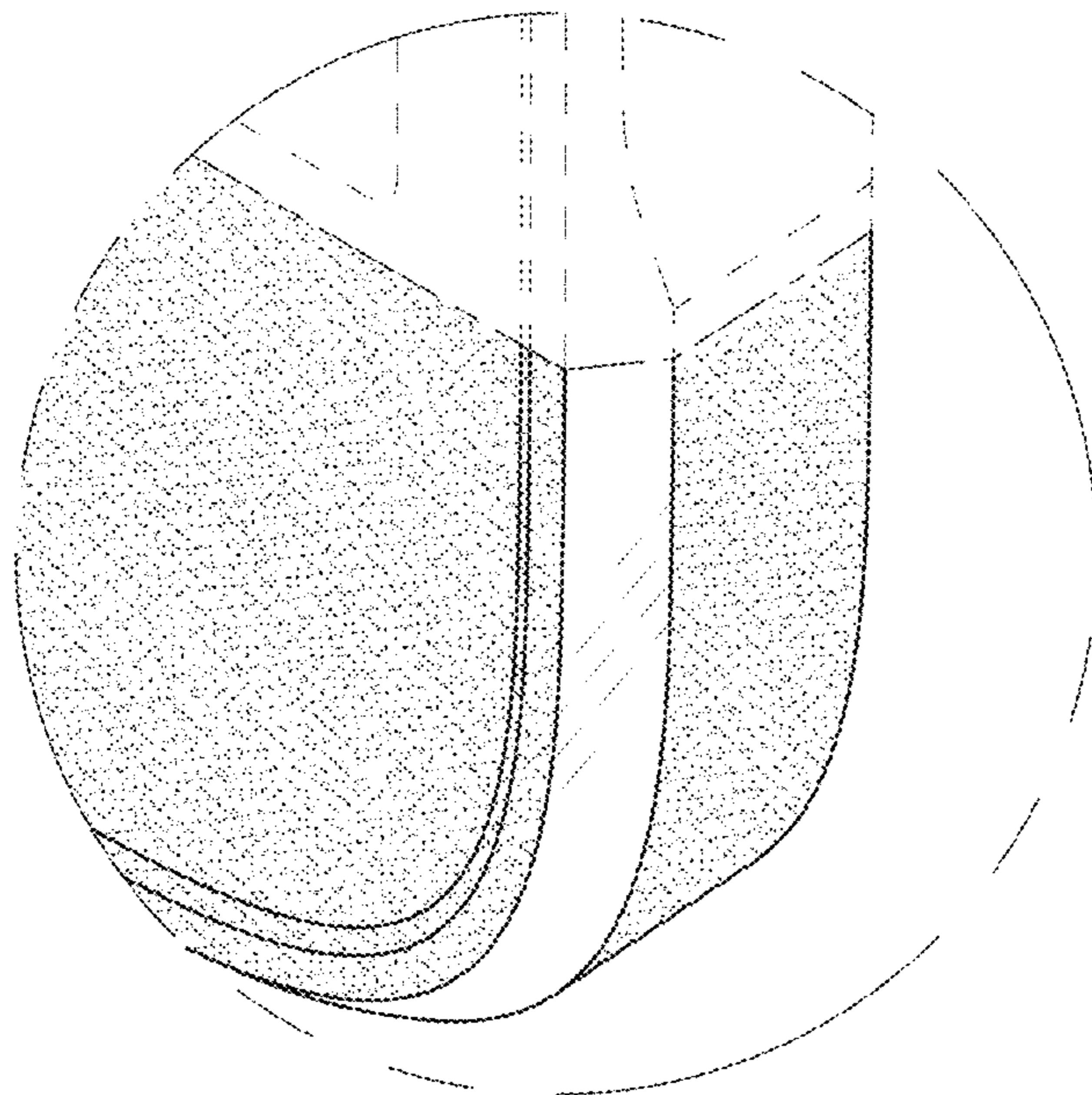

FIG.11

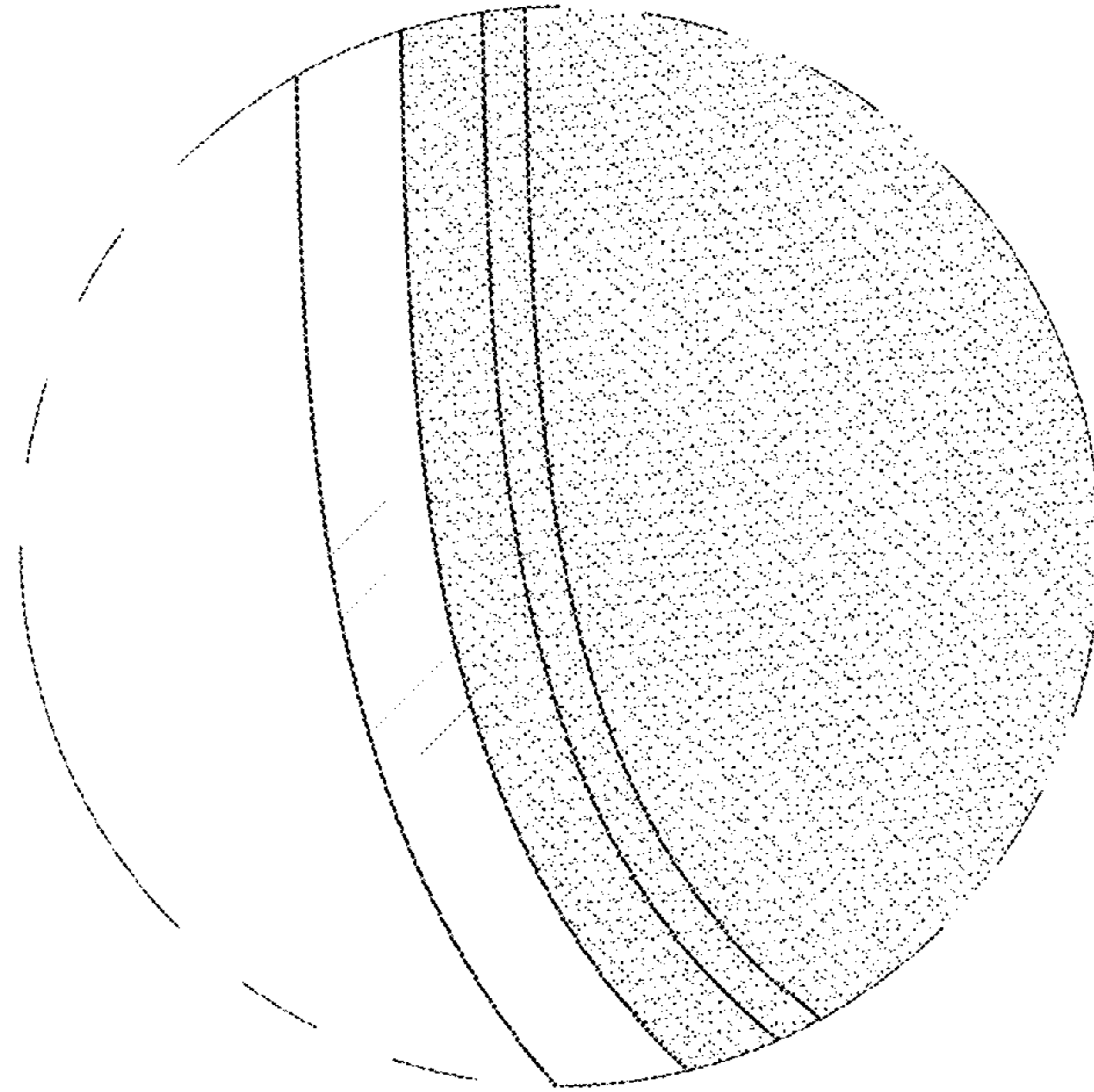

FIG.12

