



US00D786225S

(12) **United States Design Patent** (10) **Patent No.:** **US D786,225 S**
Kim (45) **Date of Patent:** **** May 9, 2017**

(54) **MOBILE TERMINAL**

(71) Applicant: **Samsung Electronics Co., Ltd.**,
Suwon-si (KR)

(72) Inventor: **Hak-Do Kim**, Seoul (KR)

(73) Assignee: **Samsung Electronics Co., Ltd.**,
Suwon-si (KR)

(**) Term: **14 Years**

(21) Appl. No.: **29/499,112**

(22) Filed: **Aug. 12, 2014**

(30) **Foreign Application Priority Data**

May 28, 2014 (KR) 30-2014-0026257

(51) **LOC (10) Cl.** **14-03**

(52) **U.S. Cl.**
USPC **D14/248**

(58) **Field of Classification Search**
USPC D14/138 G, 138 AD, 341, 138 R, 496,
D14/203.1, 203.3, 203.5, 203.7, 144, 250,
D14/248; 455/575.1, 556.2, 575.3, 575.4;
D21/517, 329; 379/433.01, 433.04;
361/679.3, 679.56
CPC .. G06F 1/1626; H04M 1/0266; H04M 1/0202
See application file for complete search history.

(56) **References Cited**

U.S. PATENT DOCUMENTS

D577,904 S * 10/2008 Sasaki D3/201
D650,766 S * 12/2011 Hong D14/138 G
D652,404 S * 1/2012 Okada D14/138 G
D656,918 S * 4/2012 Kim D14/138 G
D663,280 S * 7/2012 Lee D14/138 AD
D668,629 S * 10/2012 Chung D14/138 G
D669,447 S * 10/2012 Hong D14/138 G

D681,578 S * 5/2013 Park D14/138 G
D688,643 S * 8/2013 Park D14/138 G
D691,576 S * 10/2013 Lee D14/138 G

(Continued)

OTHER PUBLICATIONS

Galaxy S5 Active vs Galaxy S5, published on YouTube May 21,
2014, Total Tech, [online], [site visited Sep. 20, 2016]. Available
from Internet, <URL:https://www.youtube.com/watch?v=U4t-YI_
IGOU>.*

(Continued)

Primary Examiner — Jeffrey D Asch
(74) *Attorney, Agent, or Firm* — NSIP Law

(57) **CLAIM**

I claim the ornamental design for a mobile terminal, as
shown and described.

DESCRIPTION

FIG. 1 is a rear perspective view of a mobile terminal
showing my new design;
FIG. 2 is a rear view thereof;
FIG. 3 is a front view thereof;
FIG. 4 is a right-side view thereof;
FIG. 5 is a left-side view thereof;
FIG. 6 is a top view thereof;
FIG. 7 is a bottom view thereof; and,
FIG. 8 is an enlarged view of the encircled portion in FIG.
1.

The broken lines in the figures that are immediately adjacent
to the shaded areas and define unshaded regions represent
the bounds of the claim. All other broken lines, that is, the
features within broken line boundaries and broken lines
outside of the claimed design, are directed to environment.
The broken lines form no part of the claimed design.

The dot-dash broken lines encircling portions of the claimed
design that are illustrated in enlargements form no part of the
claimed design.

1 Claim, 6 Drawing Sheets

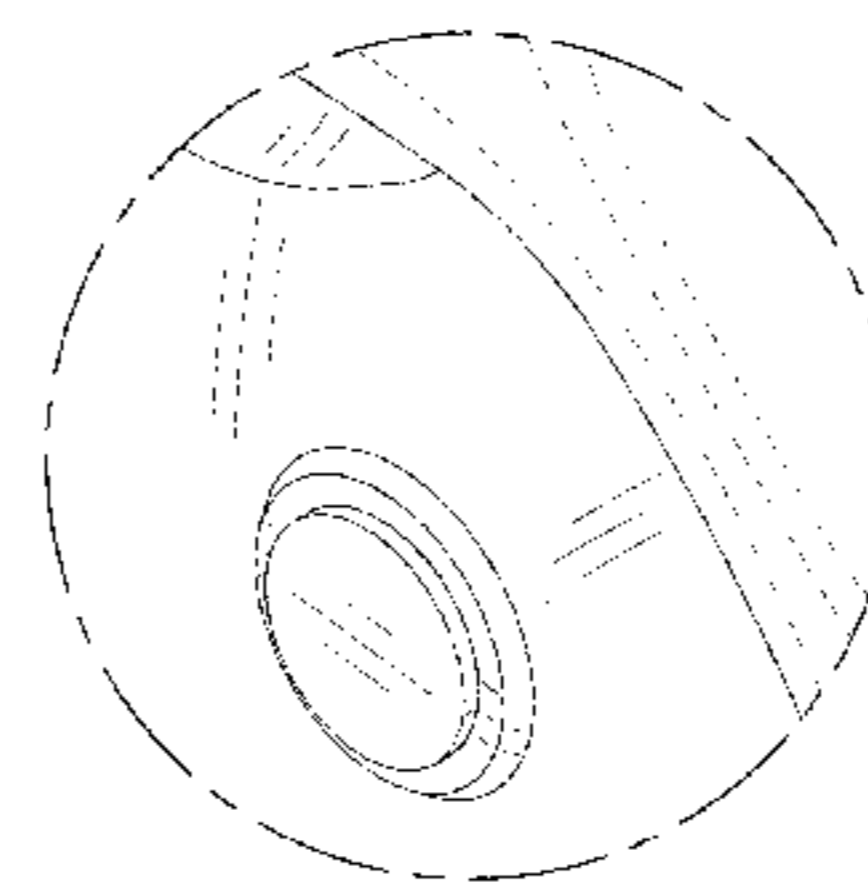
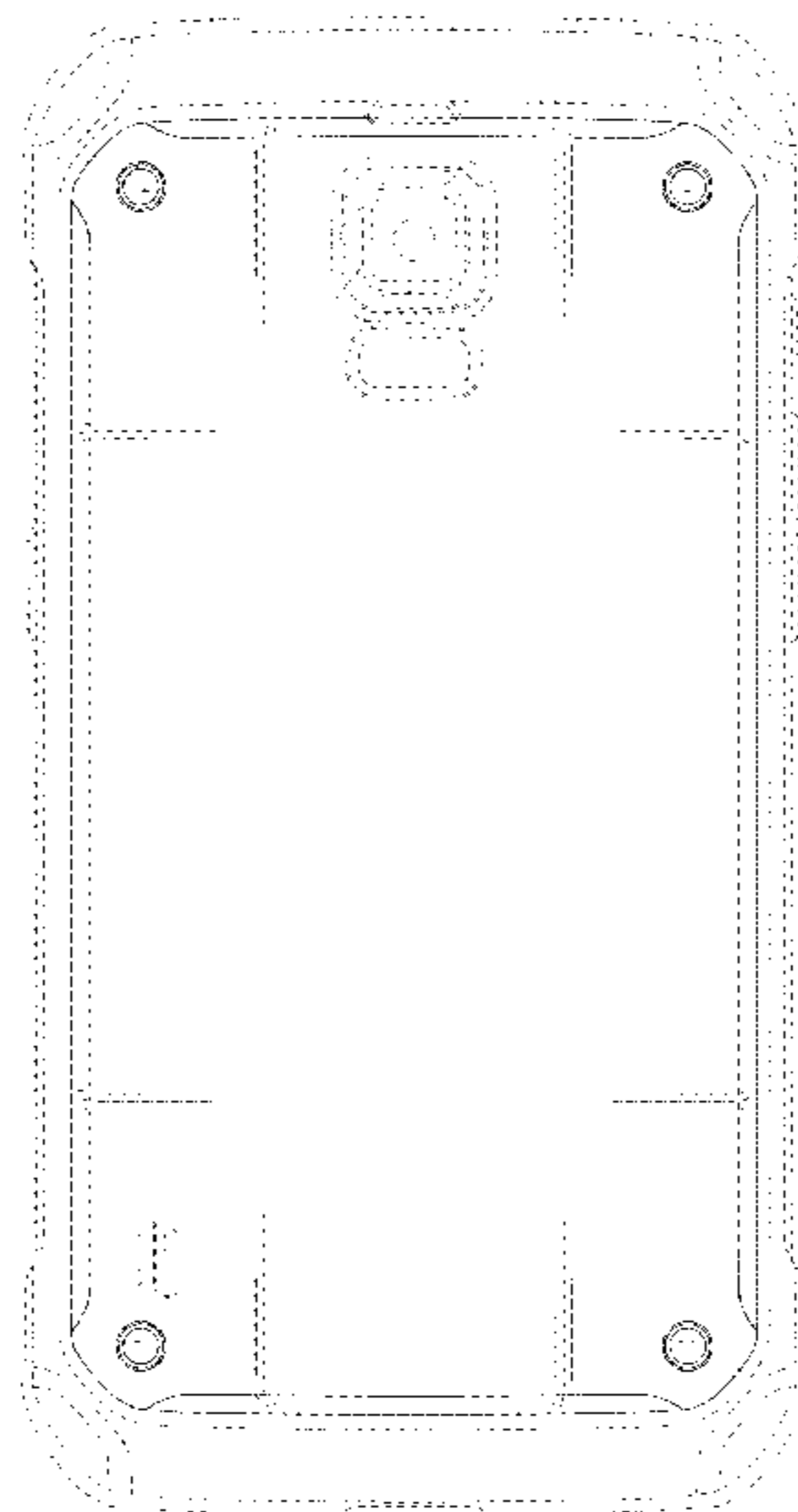

(56)

References Cited

U.S. PATENT DOCUMENTS

D692,406	S	*	10/2013	Kim	D14/138	AD
D694,213	S	*	11/2013	Park	D14/138	G
D701,203	S	*	3/2014	Katori	D14/341	
D707,644	S	*	6/2014	Asano	D14/138	G
D712,864	S	*	9/2014	Hirota	D14/138	G
D720,318	S	*	12/2014	Kim	D14/138	G
D720,339	S	*	12/2014	Kim	D14/248	
D723,495	S	*	3/2015	Jeong	D14/138	G
D724,063	S	*	3/2015	Lee	D14/248	
D733,110	S	*	6/2015	Lee	D14/248	
D737,259	S	*	8/2015	Choi	D14/248	
D742,865	S	*	11/2015	Choi	D14/248	
D747,285	S	*	1/2016	Kim	D14/138	G
D758,361	S	*	6/2016	Yeo	D14/341	
D766,200	S	*	9/2016	Qin	D14/138	AA
D770,408	S	*	11/2016	Lee	D14/138	G

OTHER PUBLICATIONS

Samsung GalaxyS5 Active, Released May 2014, [online], [site visited Sep. 20, 2016]. Available from Internet, <URL: http://www.gsmarena.com/samsung_galaxy_s5_active-6356.php>.*

Samsung Rugby Smart I847, Released Mar. 2012, [online], [site visited Sep. 20, 2016]. Available from Internet, <URL: http://www.gsmarena.com/samsung_rugby_smart_i847-4564.php>.*

Samsung Galaxy Xcover 3, Released Apr. 2015, [online], [site visited Sep. 20, 2016]. Available from Internet, <URL: http://www.gsmarena.com/samsung_galaxy_xcover_3-6990.php>.*

Samsung I9295 Galaxy S4 Active, Released Jun. 2013, [online], [site visited Sep. 20, 2016]. Available from Internet, <URL: http://www.gsmarena.com/samsung_i9295_galaxy_s4_active-5446.php>.*

Samsung Galaxy S6 active, Released Jun. 2015, [online], [site visited Sep. 20, 2016]. Available from Internet, <URL: http://www.gsmarena.com/samsung_galaxy_s6_active-7114.php>.*

Samsung Galaxy Tab Active LTE, Released Dec. 2014, [online], [site visited Sep. 20, 2016]. Available from Internet, <URL: http://www.gsmarena.com/samsung_galaxy_tab_active_lte-6658.php>.*

Cat S40, Released Aug. 2015, [online], [site visited Sep. 20, 2016]. Available from Internet, <URL: http://www.gsmarena.com/cat_s40-7456.php>.*

* cited by examiner

FIG. 1

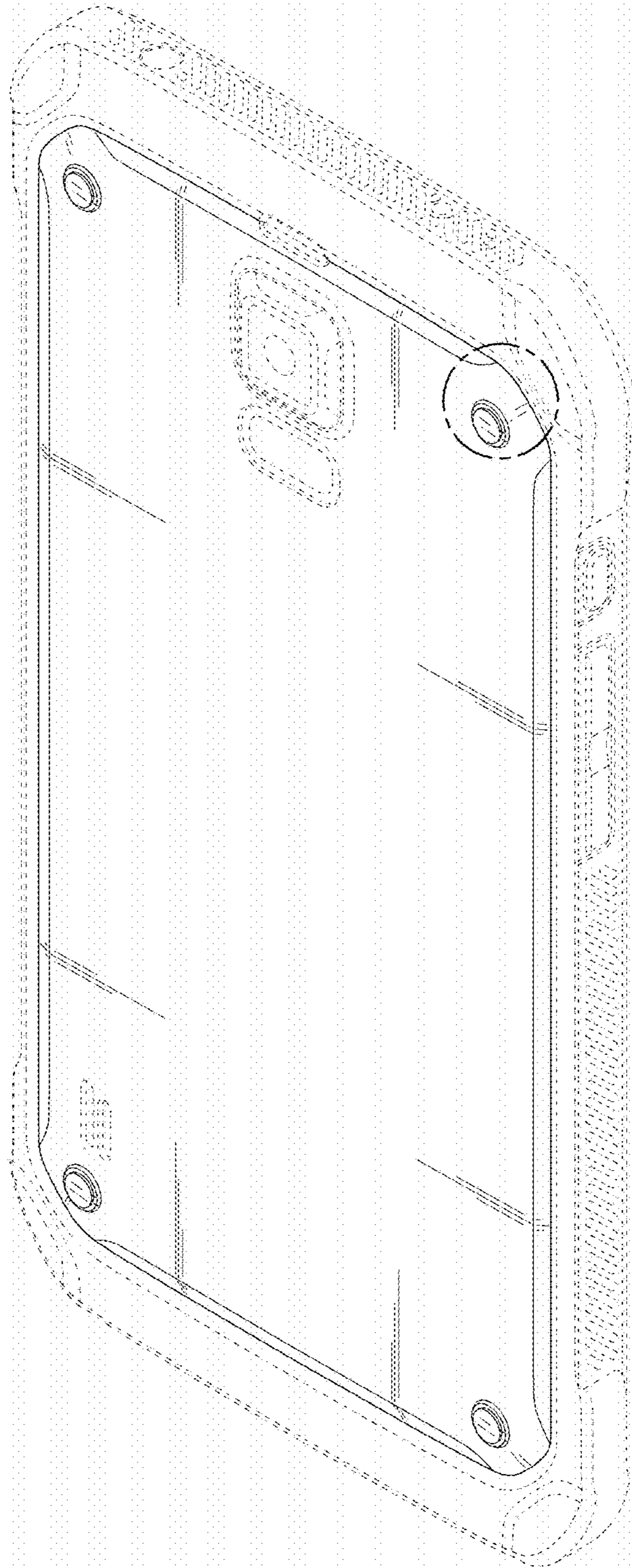

FIG. 2

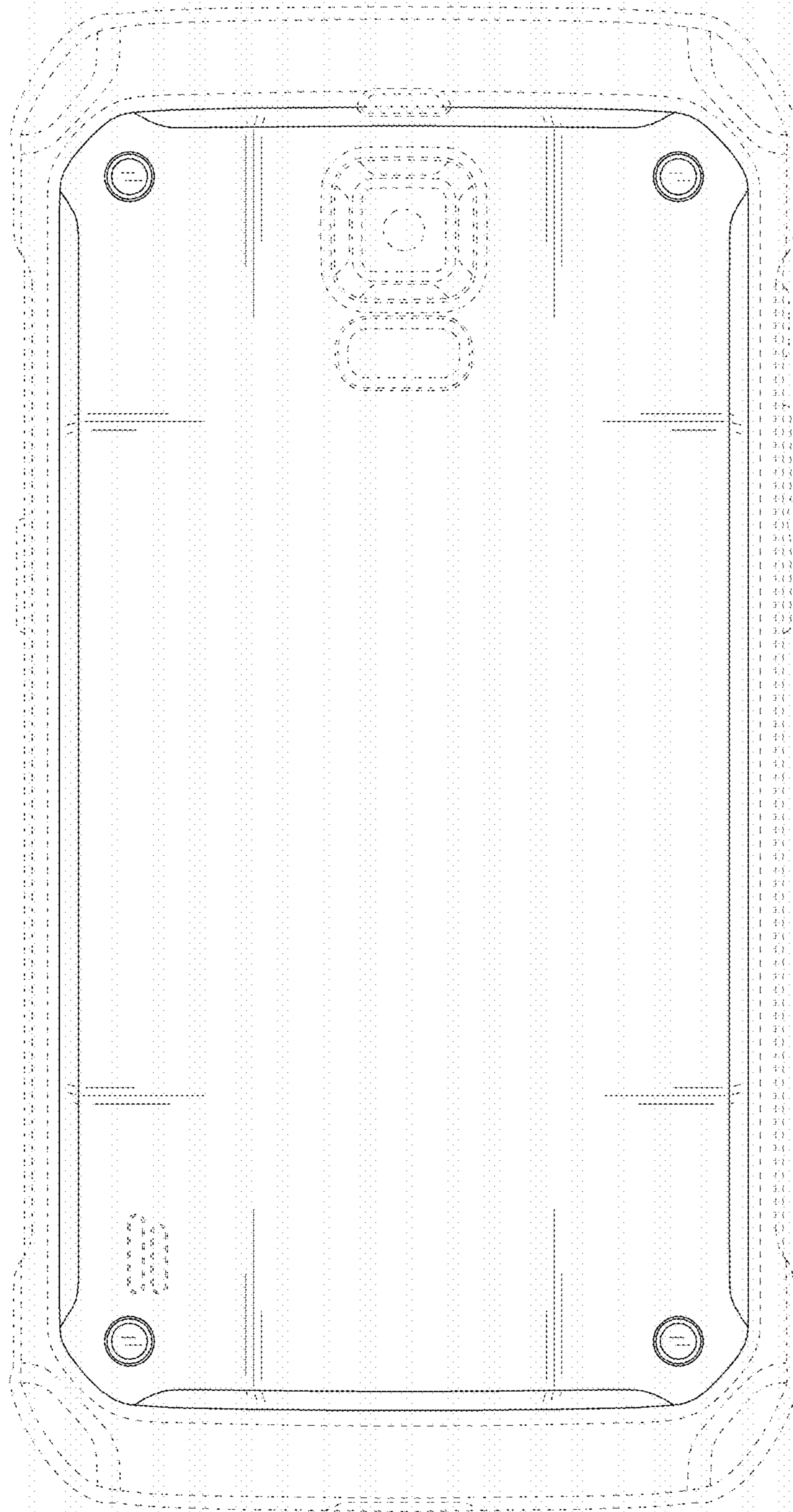

FIG. 3



FIG. 4

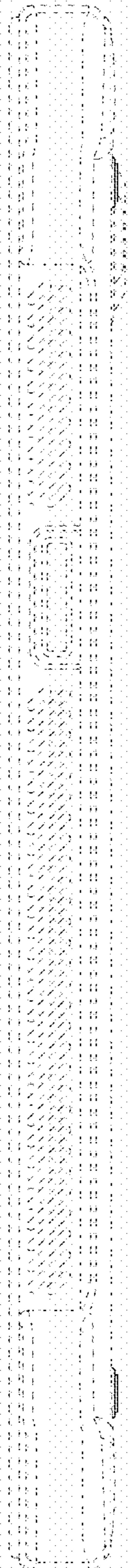

FIG. 5



FIG. 6

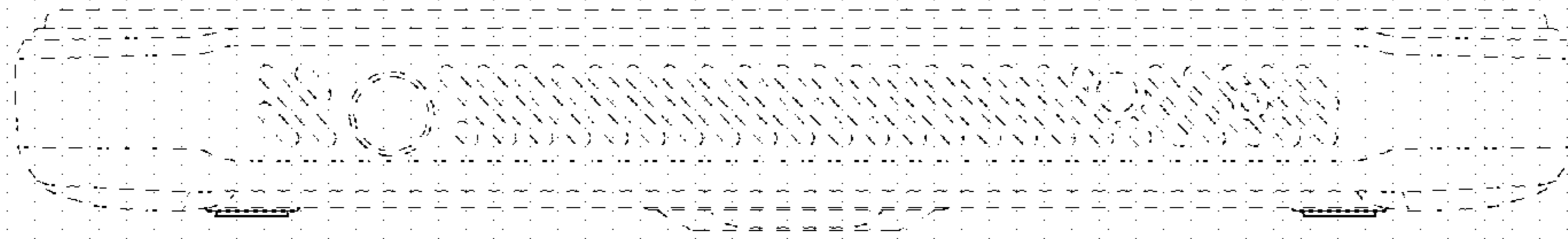

FIG. 7

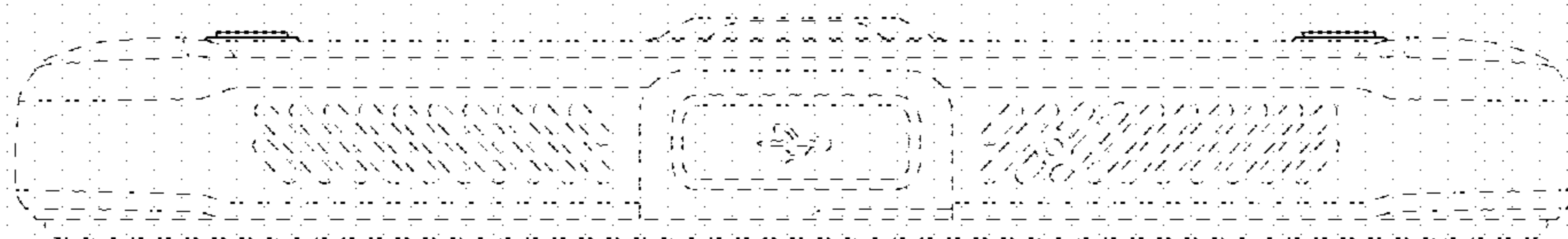

FIG. 8

