



US00D786141S

(12) **United States Design Patent** (10) **Patent No.:** **US D786,141 S**  
**Tachibana et al.** (45) **Date of Patent:** **\*\* May 9, 2017**

(54) **MOTORCYCLE FRONT SIDE COWL**  
(71) Applicant: **HONDA MOTOR CO., LTD.**, Tokyo (JP)  
(72) Inventors: **Kazuyuki Tachibana**, Wako (JP); **Daisuke Soeno**, Wako (JP)  
(73) Assignee: **HONDA MOTOR CO., LTD.**, Tokyo (JP)

D639,218 S \* 6/2011 Katagiri ..... D12/186  
D660,201 S \* 5/2012 Matsuoka ..... D12/126  
D660,202 S \* 5/2012 Petersson ..... D12/126  
D660,203 S \* 5/2012 Yamazaki ..... D12/126  
D674,323 S \* 1/2013 Tokumura ..... D12/126  
D683,274 S \* 5/2013 Yanagita ..... D12/126  
8,517,449 B2 \* 8/2013 Okubo ..... B62J 17/00  
296/78.1  
D689,411 S \* 9/2013 Tsukui ..... D12/126  
D689,800 S \* 9/2013 Futamata ..... D12/126

(Continued)

(\*\*) Term: **15 Years**  
(21) Appl. No.: **29/550,772**  
(22) Filed: **Jan. 7, 2016**

FOREIGN PATENT DOCUMENTS

JP D1464696 S 3/2013

(30) **Foreign Application Priority Data**

Jul. 8, 2015 (JP) ..... 2015-015240  
(51) **LOC (10) Cl.** ..... **12-11**  
(52) **U.S. Cl.**  
USPC ..... **D12/126**; D12/114  
(58) **Field of Classification Search**  
USPC ..... D12/110, 114, 126, 182, 184, 186  
CPC ... B62J 17/00; B62J 17/02; B62J 17/04; B62J  
23/00; B62K 11/00; B62K 11/02; B62K  
11/04  
See application file for complete search history.

OTHER PUBLICATIONS

Office Action dated Jan. 6, 2016, issued in counterpart Japanese application No. 2015-015240 (1 page).

*Primary Examiner* — Darlington Ly  
(74) *Attorney, Agent, or Firm* — Westerman, Hattori, Daniels & Adrian, LLP

(57) **CLAIM**

The ornamental design for a motorcycle front side cowl, as shown and described.

**DESCRIPTION**

FIG. 1 is a right side elevation view of a motorcycle front side cowl showing our new design;  
FIG. 2 is a top plan view thereof;  
FIG. 3 is a bottom plan view thereof;  
FIG. 4 is a front elevation view thereof;  
FIG. 5 is a rear elevation view thereof;  
FIG. 6 is a front and right side perspective view thereof; and,  
FIG. 7 is a rear and right side perspective view thereof.  
The broken lines in the drawings illustrate portions of the motorcycle front side cowl that forms no part of the claimed design.

(56) **References Cited**

U.S. PATENT DOCUMENTS

D266,159 S \* 9/1982 Johnson ..... D12/182  
D522,415 S \* 6/2006 Tanaka ..... D12/126  
D526,606 S \* 8/2006 Ban ..... D12/182  
D533,125 S \* 12/2006 Kokubu ..... D12/182  
D538,718 S \* 3/2007 Tako ..... D12/182  
D579,834 S \* 11/2008 Sawabe ..... D12/126  
D580,325 S \* 11/2008 Sawabe ..... D12/126  
D582,822 S \* 12/2008 Watanabe ..... D12/186  
D584,662 S \* 1/2009 Ichihara ..... D12/126  
D608,260 S \* 1/2010 Toriyama ..... D12/186

**1 Claim, 3 Drawing Sheets**

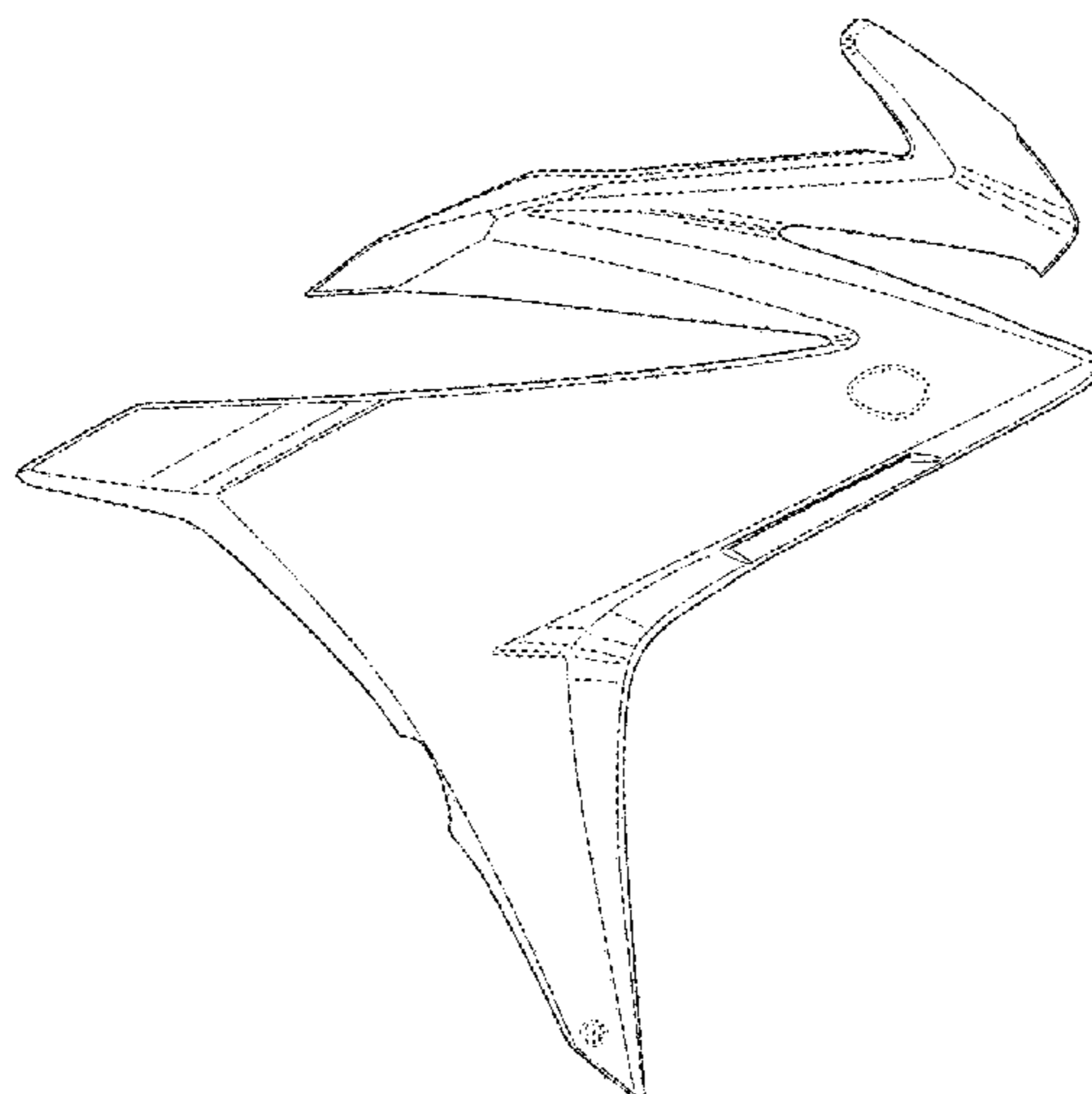

(56)

**References Cited**

U.S. PATENT DOCUMENTS

D690,627	S *	10/2013	Tsukui .....	D12/126
D694,157	S	11/2013	Katagiri et al.	
D695,157	S *	12/2013	Tsukui .....	D12/126
D712,795	S *	9/2014	Tokumura .....	D12/114
D717,699	S *	11/2014	Tako .....	D12/110
D726,595	S *	4/2015	Futamata .....	D12/114
D730,249	S *	5/2015	Ishiguri .....	D12/110
D733,010	S *	6/2015	Tako .....	D12/126
D736,680	S *	8/2015	Nishimoto .....	D12/126
D748,017	S *	1/2016	Yoshitomi .....	D12/114
2006/0087144	A1 *	4/2006	Kamimura .....	B62J 17/02 296/78.1
2009/0108629	A1 *	4/2009	Takahashi .....	B62K 11/04 296/192
2009/0108630	A1 *	4/2009	Nakao .....	B62K 11/04 296/192
2011/0233956	A1 *	9/2011	Okubo .....	B62J 17/00 296/78.1

\* cited by examiner

FIG.1

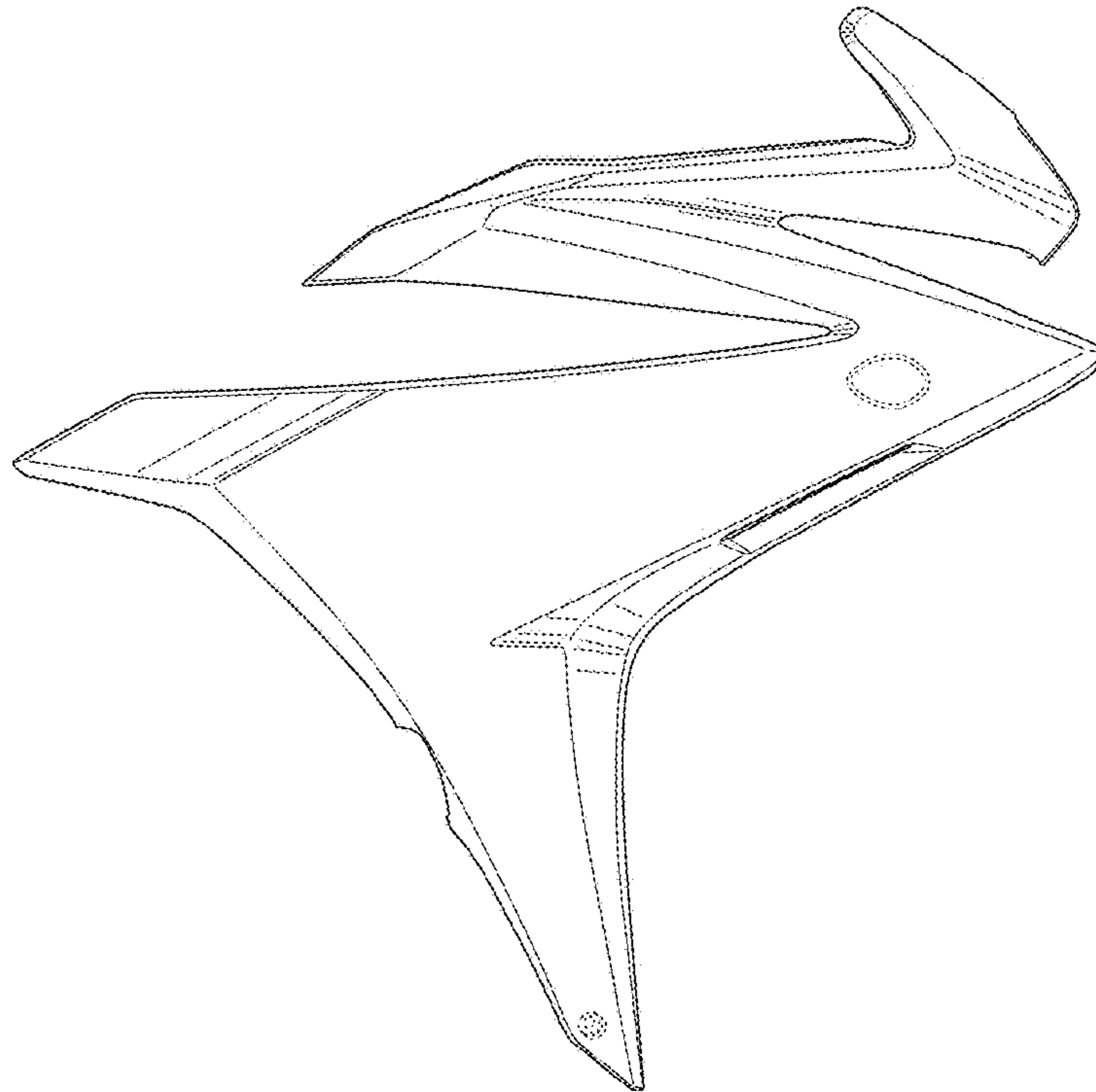

FIG.2

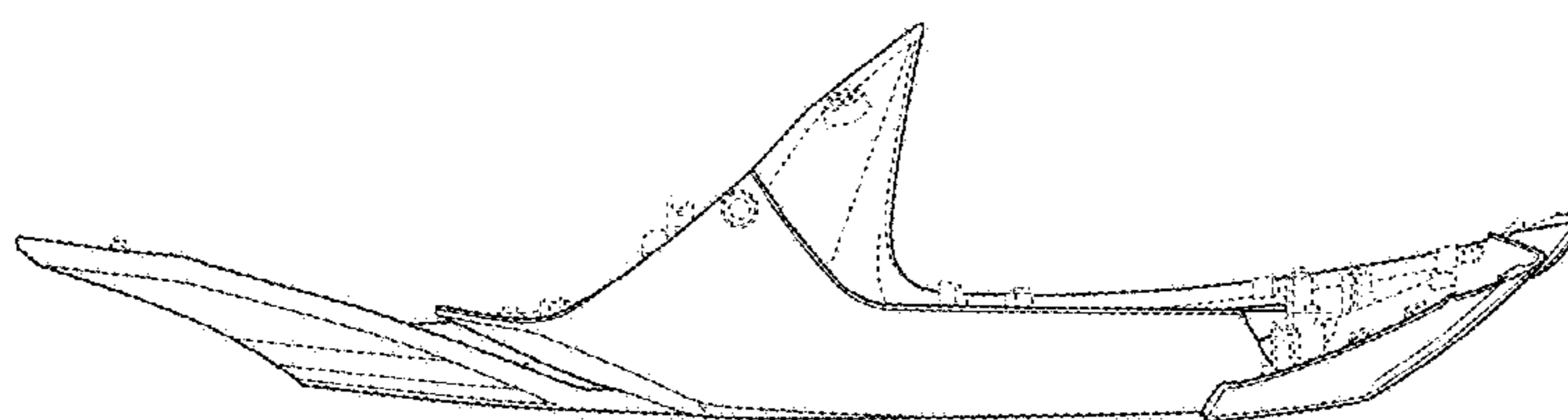

FIG.3

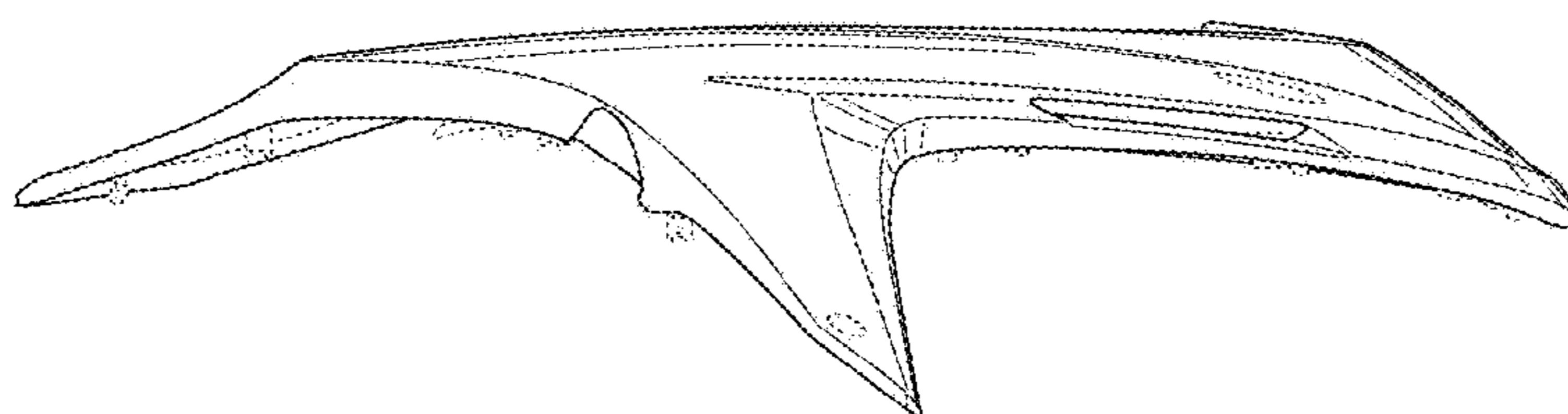

FIG.4

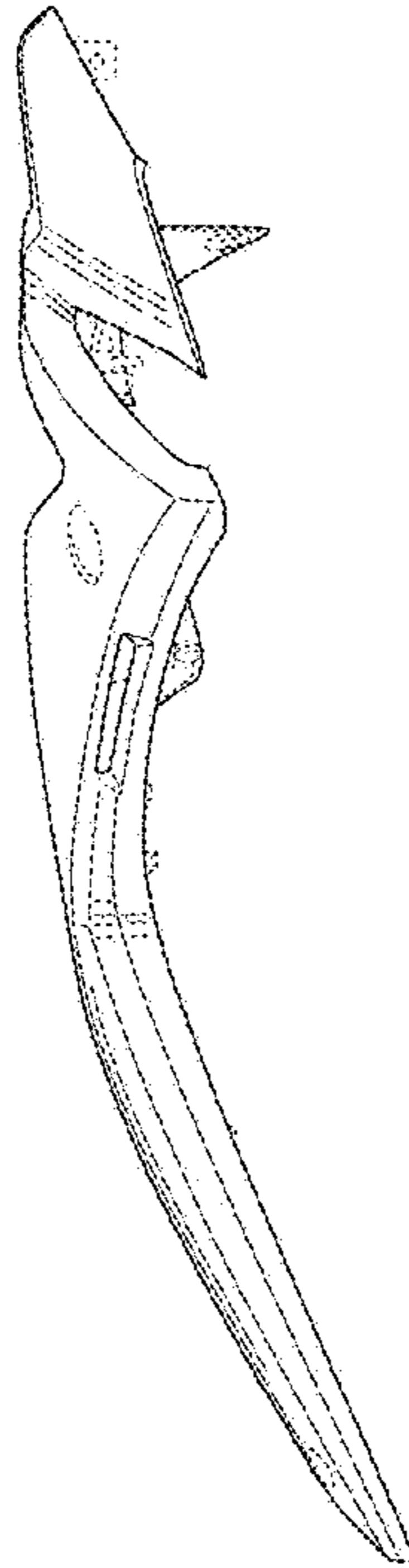

FIG.5

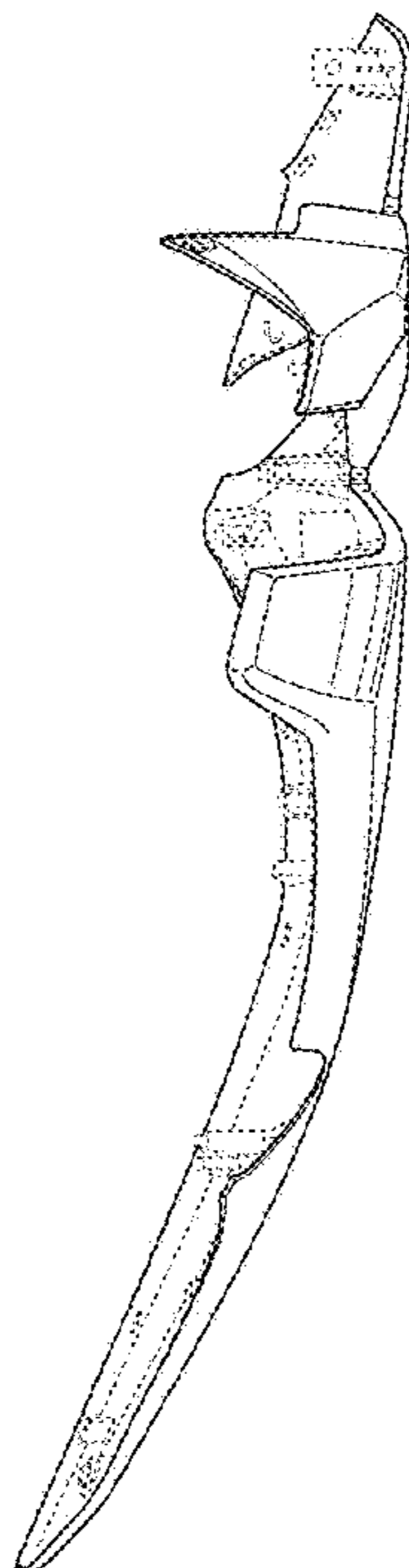

FIG.6

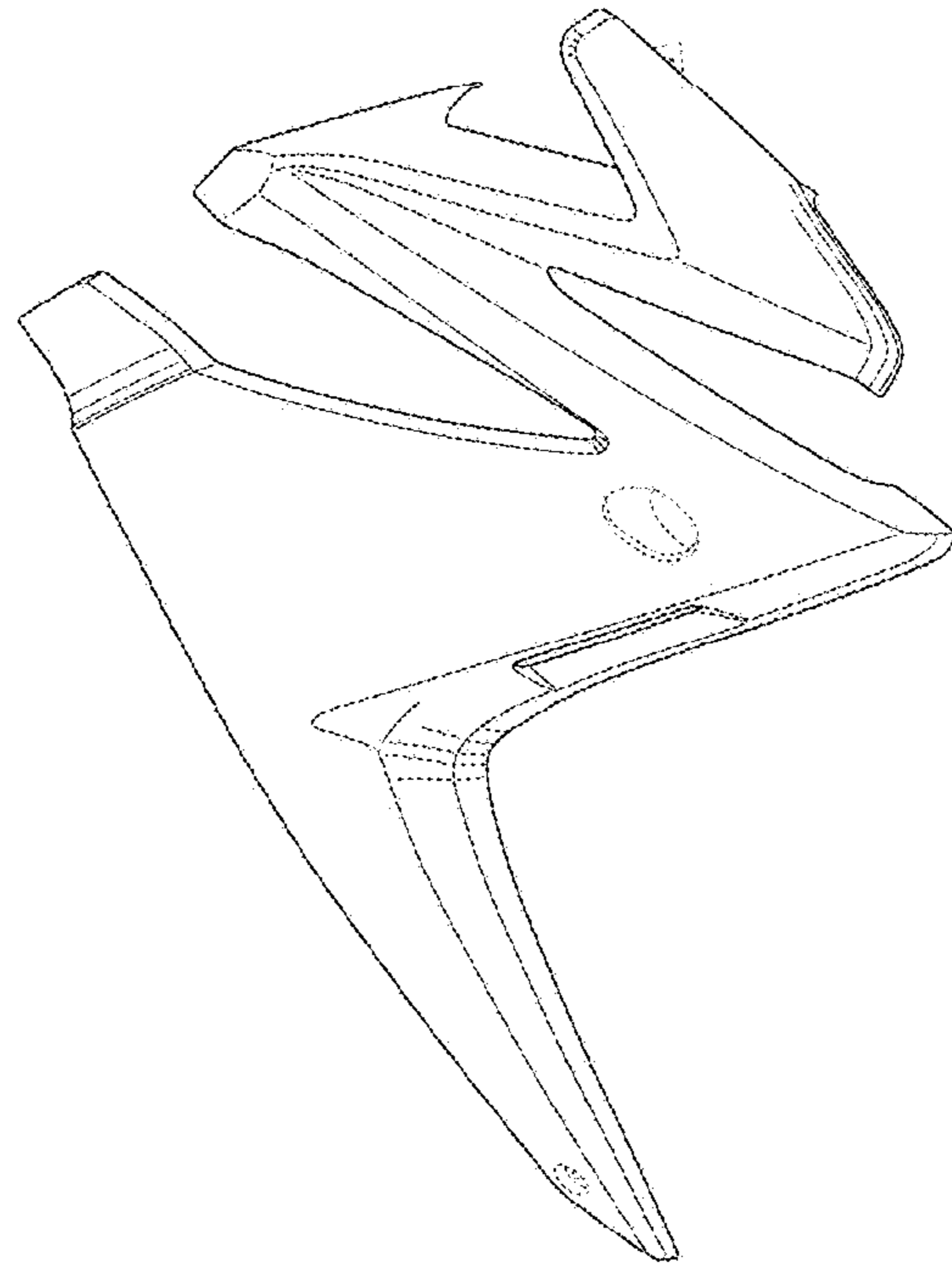

FIG.7

