



US00D786128S

(12) **United States Design Patent** (10) **Patent No.:** **US D786,128 S**
Leung (45) **Date of Patent:** **** May 9, 2017**

(54) **HEART CROSS JEWELRY**
(71) Applicant: **Shui Chun Leung**, Floral Park, NY (US)
(72) Inventor: **Shui Chun Leung**, Floral Park, NY (US)
(**) Term: **15 Years**
(21) Appl. No.: **29/560,836**
(22) Filed: **Apr. 11, 2016**
(51) **LOC (10) Cl.** **11-03**
(52) **U.S. Cl.**
USPC **D11/96; D11/103**
(58) **Field of Classification Search**
USPC D11/95-96, 121, 103, 56, 175; 63/1.11, 63/3, 3.1, 3.2, 4, 10, 12, 13, 14.1, 20-21, 63/23, 28, 33, 35, 41; D99/23, 25, 27; 428/3
CPC A44C 11/002; A44C 11/005; A44C 15/00; A44C 15/001; A44C 15/0025; A44C 15/005; A44C 17/04; A44C 25/001; A44C 25/005; A44C 5/2038; A44C 5/2085; A44C 5/2095; A44C 7/00; A44C 7/003; A47G 33/02
See application file for complete search history.

D465,432 S * 11/2002 Henmi D11/96
D467,196 S * 12/2002 Pinto D11/96
6,546,750 B1 * 4/2003 Bolster A47G 33/02 63/3
D475,652 S * 6/2003 Schlieger D11/103
6,804,977 B1 * 10/2004 Grabelle A44C 5/2085 63/3
D506,948 S * 7/2005 Gehrke D11/96
D528,038 S * 9/2006 Cavness D11/157
D533,477 S * 12/2006 Felley D11/103
D544,811 S * 6/2007 Perkins D11/56
D580,815 S * 11/2008 Powell D11/96
D604,660 S * 11/2009 Marks D11/56
D619,926 S * 7/2010 Letney D99/23
D628,116 S * 11/2010 Marks D11/79
D628,932 S * 12/2010 Tirakian D11/56
D635,049 S * 3/2011 Marks D11/56
D639,695 S * 6/2011 Nudelman D11/56
7,980,095 B1 * 7/2011 Masterson A44C 11/002 63/3.1
D656,429 S * 3/2012 Cadigan D11/96
(Continued)

Primary Examiner — Ian Simmons
Assistant Examiner — Mark Cavanna
(74) *Attorney, Agent, or Firm* — Michael J. Feigin, Esq.; Feigin & Fridman LLC

(57) **CLAIM**

The ornamental design for the heart cross jewelry, as shown and described.

(56) **References Cited**

U.S. PATENT DOCUMENTS

D251,717 S * 5/1979 Graves D11/103
D257,069 S * 9/1980 Wozniski D11/104
5,203,183 A * 4/1993 Salerno A44C 7/00 63/12
5,383,343 A * 1/1995 Thach A44C 25/001 63/21
D371,983 S * 7/1996 Burman D11/103
5,632,164 A * 5/1997 Bergagnini A44C 17/04 63/23
D435,712 S * 12/2000 Knudsen D99/27

DESCRIPTION

FIG. 1 shows a top perspective view of the heart cross jewelry.
FIG. 2 shows a top plan view thereof.
FIG. 3 shows a bottom plan view thereof.
FIG. 4 shows a left side elevation view thereof.
FIG. 5 shows a right side elevation view thereof.
FIG. 6 shows a top view thereof; and,
FIG. 7 shows a bottom view thereof.

1 Claim, 5 Drawing Sheets

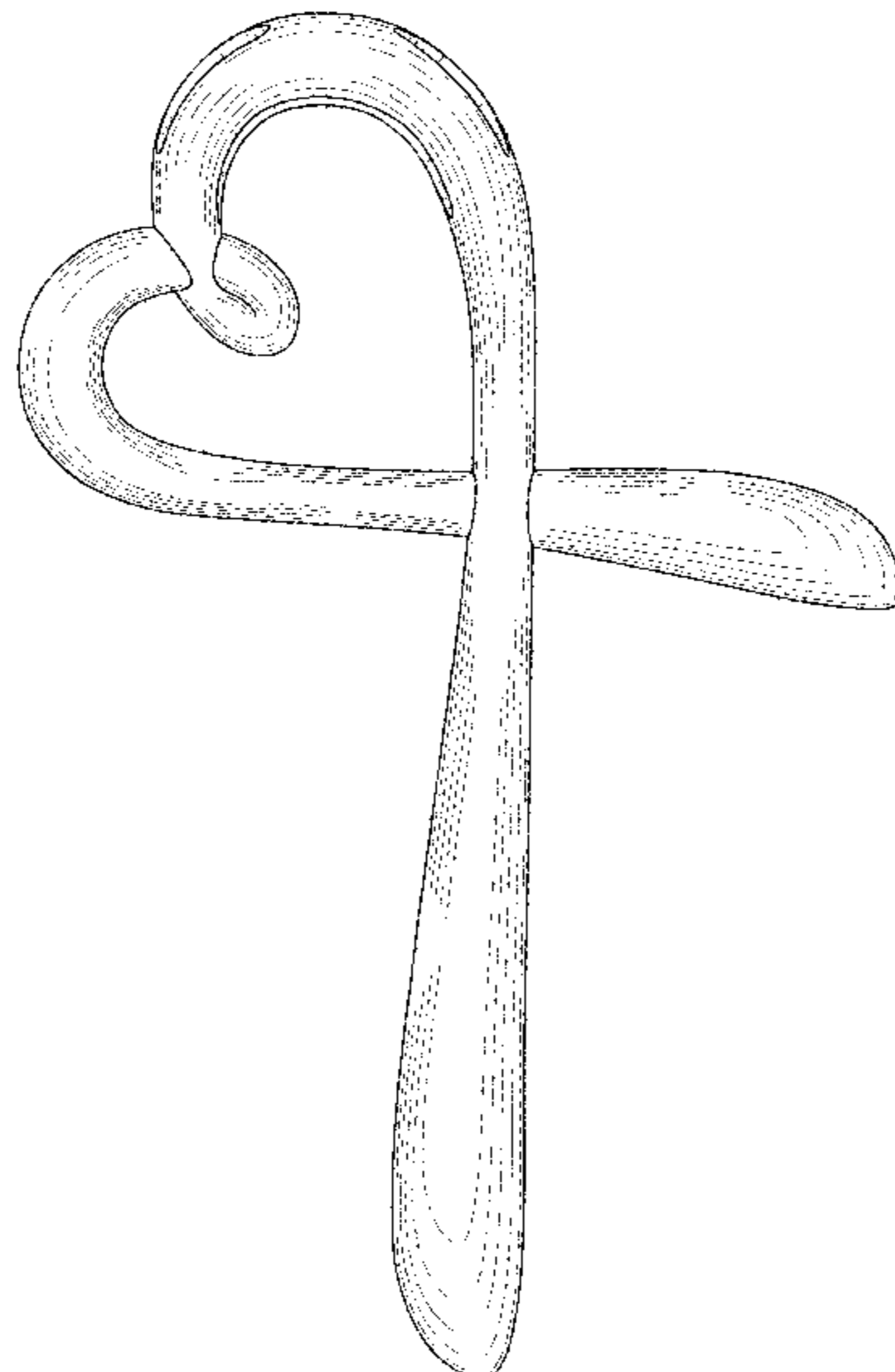

(56)

References Cited

U.S. PATENT DOCUMENTS

D685,288 S * 7/2013 Clark D11/96
D687,338 S * 8/2013 Cadigan D11/96
D691,511 S * 10/2013 Macumber D11/96
9,364,056 B1 * 6/2016 Azar A44C 25/001
D766,125 S * 9/2016 Behney D11/56
D772,753 S * 11/2016 Bresser D11/96
2012/0118014 A1 * 5/2012 King A44C 25/001
63/1.13
2013/0036768 A1 * 2/2013 Hernandez A44C 25/005
63/23
2014/0212856 A1 * 7/2014 Liberman A44C 11/005
63/23
2015/0047392 A1 * 2/2015 Kelly A44C 5/2038
63/23
2015/0308489 A1 * 10/2015 Yakubovich A44C 15/0025
63/10
2016/0143404 A1 * 5/2016 Wright A44C 25/005
63/23
2016/0324279 A1 * 11/2016 Ruan A44C 15/001

* cited by examiner

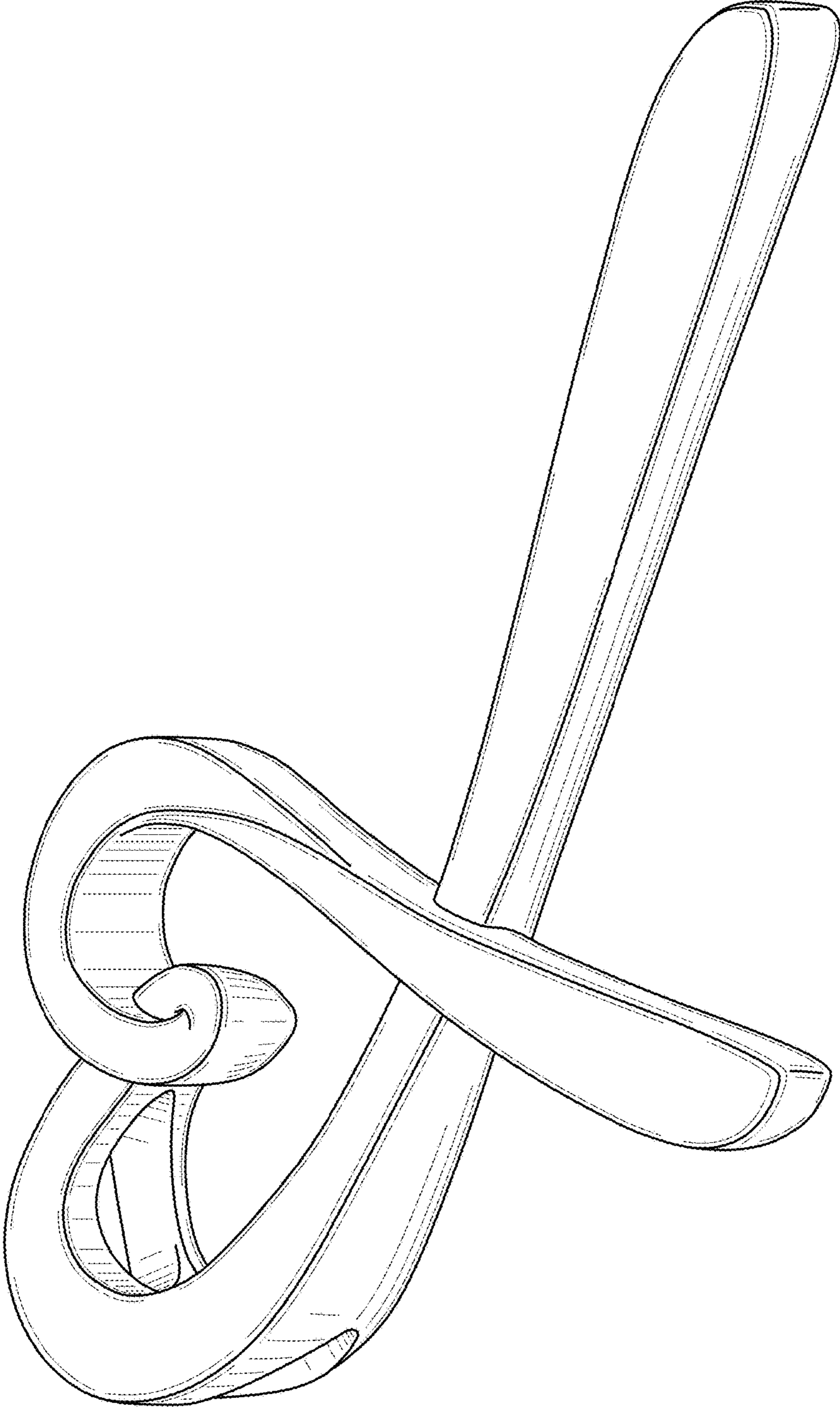

FIG. 1

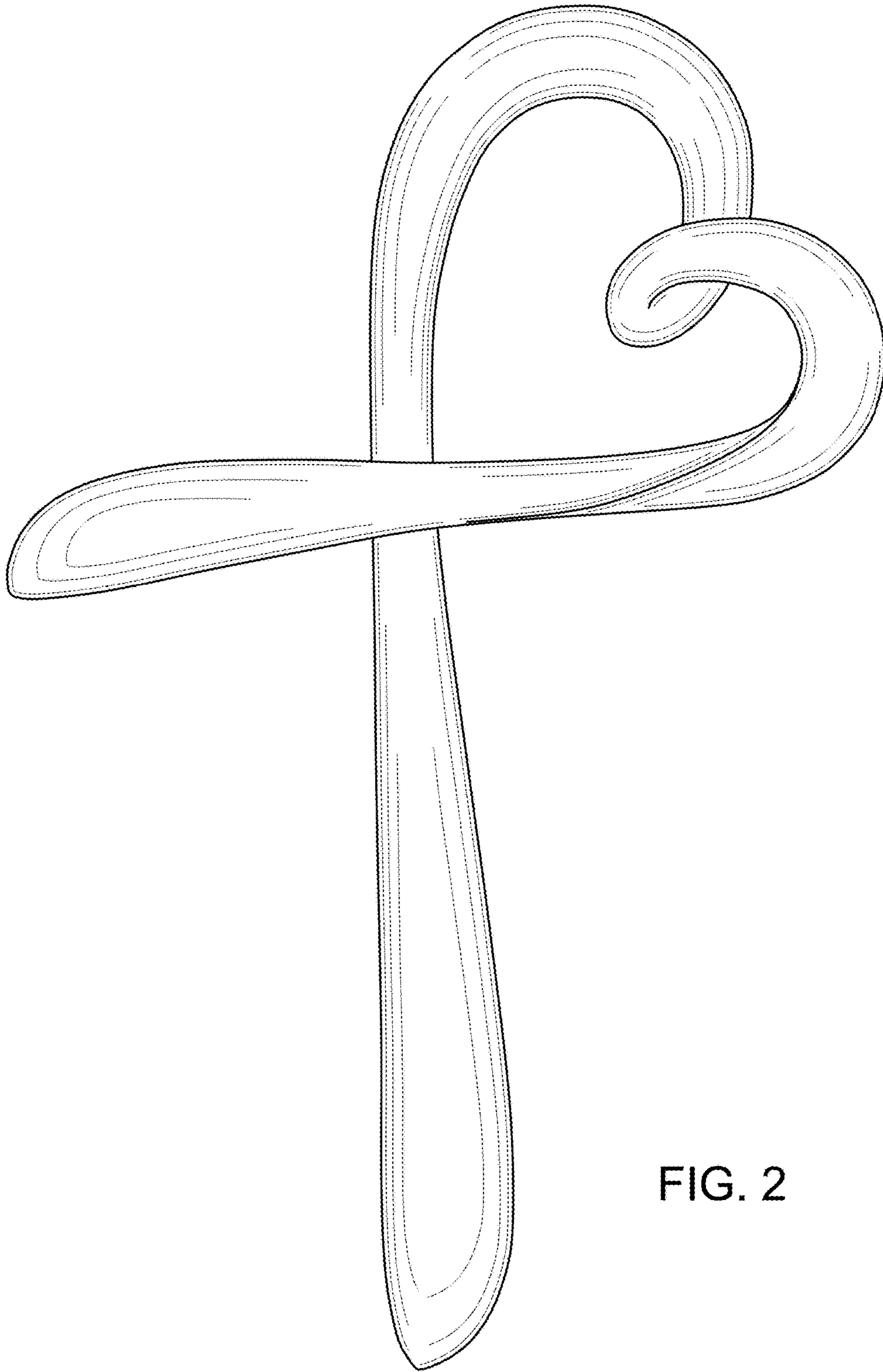

FIG. 2

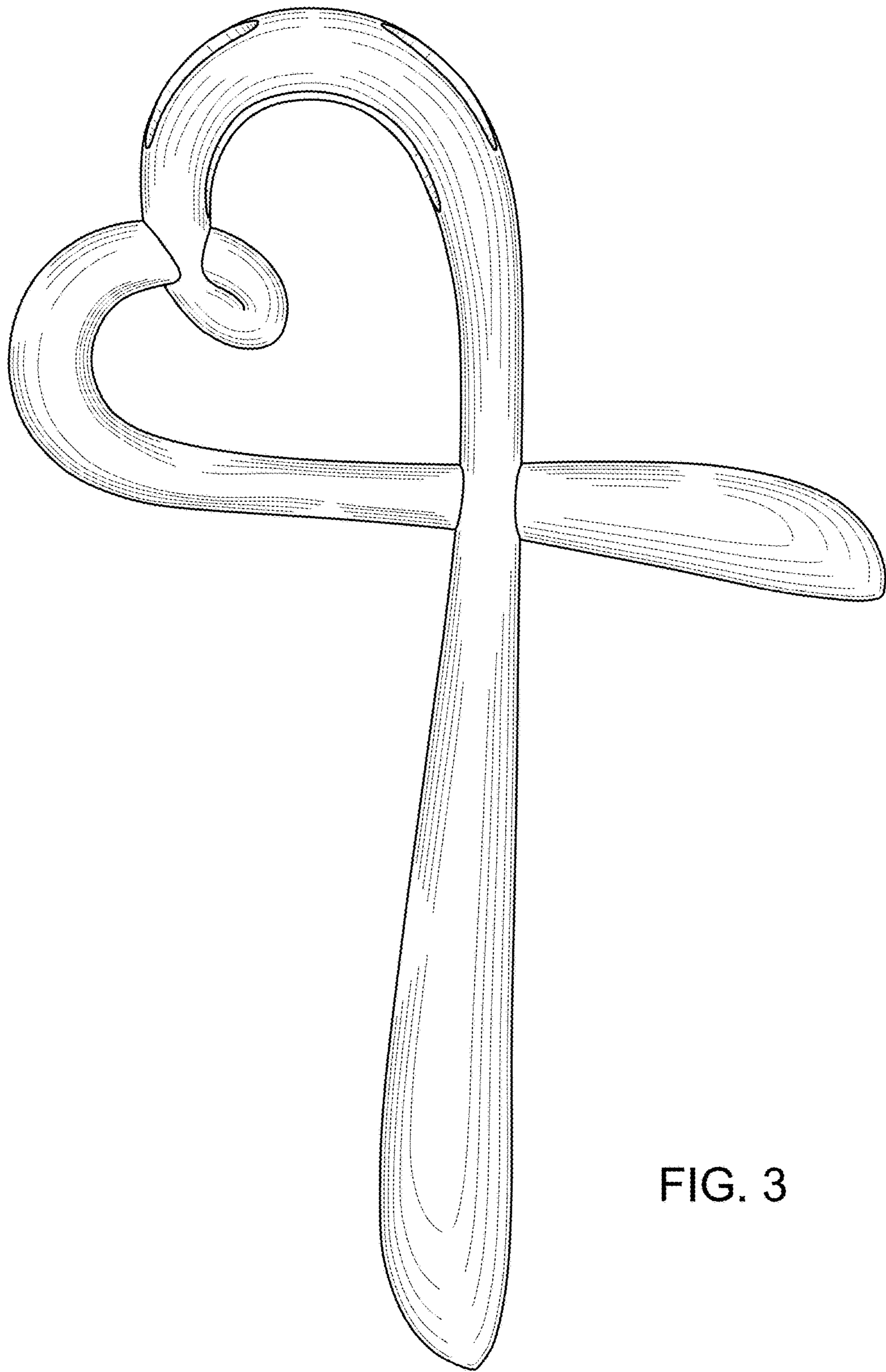

FIG. 3

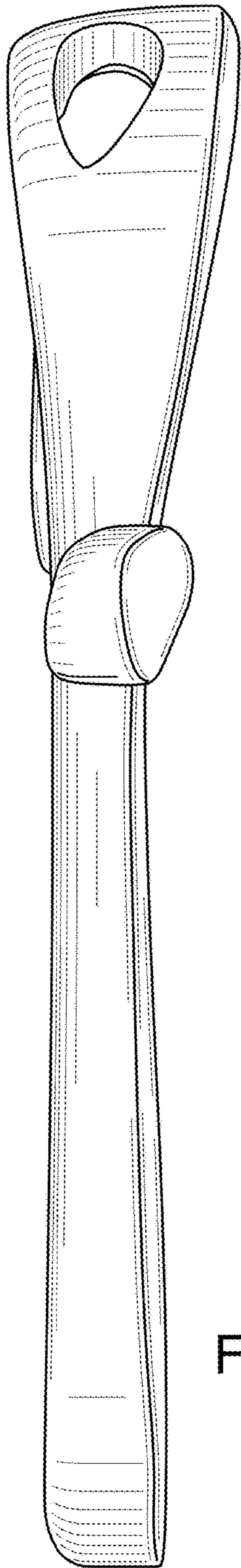

FIG. 4

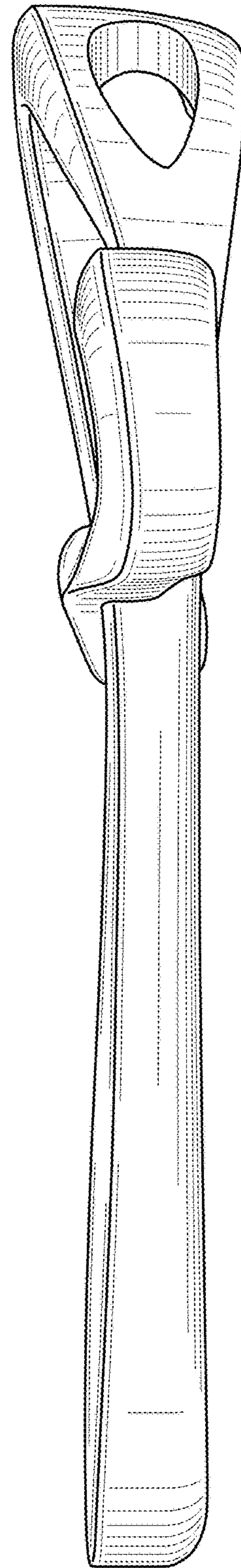

FIG. 5

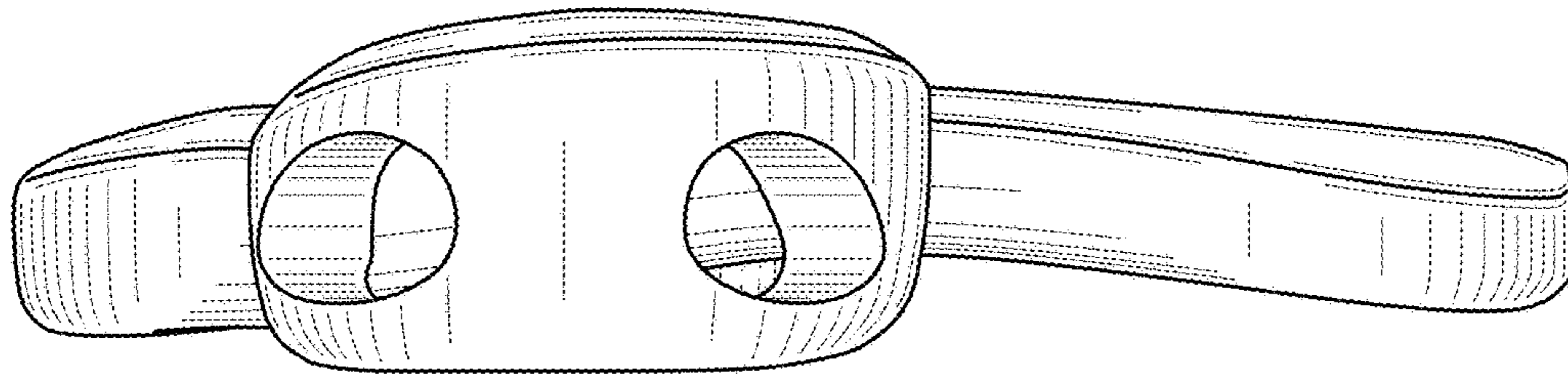

FIG. 6

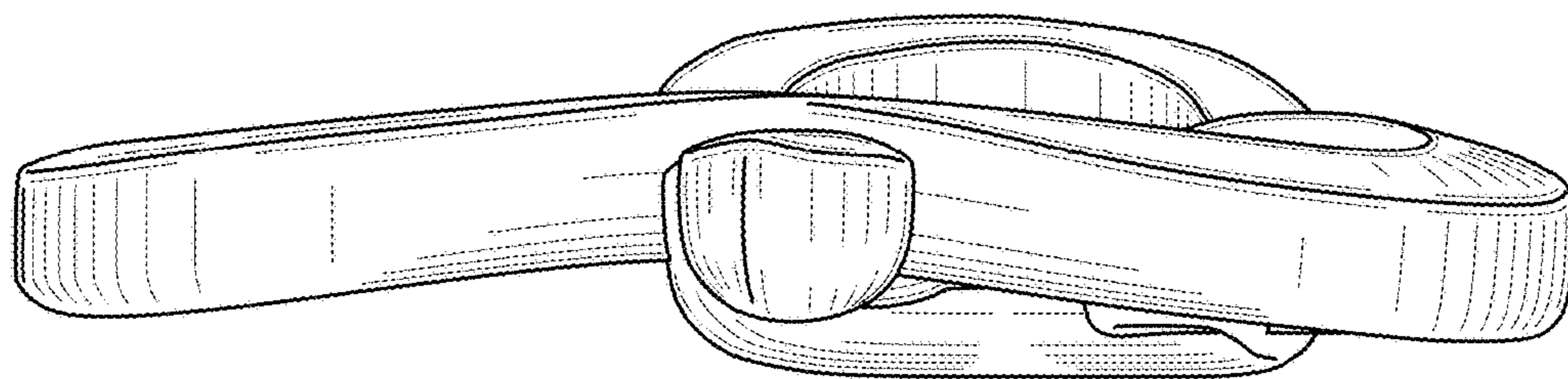

FIG. 7