



US00D786011S

(12) **United States Design Patent** (10) **Patent No.:** **US D786,011 S**
Creech et al. (45) **Date of Patent:** **** May 9, 2017**

- (54) **MELON STAND**
- (71) Applicants: **Deborah Lou Creech**, Cary, NC (US);
Charles Noel Creech, Jr., Cary, NC (US)
- (72) Inventors: **Deborah Lou Creech**, Cary, NC (US);
Charles Noel Creech, Jr., Cary, NC (US)
- (**) Term: **15 Years**
- (21) Appl. No.: **29/535,358**
- (22) Filed: **Aug. 5, 2015**

2,682,668	A *	7/1954	Hoeflich	A42B 1/208
					2/195.1
2,985,886	A *	5/1961	Frasch	A42B 1/16
					2/209.3
3,161,394	A *	12/1964	Savitt	A47G 23/03
					215/394
4,537,397	A *	8/1985	Kopp	A63B 69/0075
					473/420
4,719,651	A *	1/1988	Tereshinski	A42B 1/004
					2/200.3
D337,364	S *	7/1993	Piper	D21/717
D379,107	S *	5/1997	Loch	D1/118
6,170,788	B1 *	1/2001	Stevenson	A01G 13/0237
					248/153
D463,927	S *	10/2002	Trau	D6/718.29
D484,343	S *	12/2003	Plesnicar	D6/552
D539,055	S *	3/2007	Kershaw	D11/131
D596,452	S *	7/2009	Komorski	D7/387
D660,654	S *	5/2012	Radinsky	D7/624.1
D704,286	S *	5/2014	Yu	D21/717
9,302,163	B1 *	4/2016	Maldonado	A63B 57/0018
2005/0150795	A1 *	7/2005	Kershaw	A63B 47/00
					206/315.9

Related U.S. Application Data

- (63) Continuation of application No. 13/792,644, filed on Mar. 11, 2013, now abandoned.
- (51) **LOC (10) Cl.** **07-99**
- (52) **U.S. Cl.**
USPC **D7/388**; D7/396.6; D7/406; D7/624.1
- (58) **Field of Classification Search**
USPC D7/506, 507, 505, 503, 600.1, 624.1,
D7/633, 388, 397, 389, 396.6, 403, 404,
D7/409; D21/717, 712; D28/73;
248/153, 346.5
CPC .. A47G 19/30; A42B 1/004; A63B 357/0018;
A63B 47/00; F16M 13/00; A47J 43/00;
A01G 13/02
See application file for complete search history.

* cited by examiner

Primary Examiner — Marianne Pandozzi
(74) *Attorney, Agent, or Firm* — NK Patent Law, PLLC

(57) **CLAIM**

We claim the ornamental design for the melon stand, as shown and described.

DESCRIPTION

FIG. 1 is a top view of the melon stand;
FIG. 2 is a bottom view of the melon stand;
FIG. 3 is a front view of the melon stand;
FIG. 4 is a back view of the melon stand;
FIG. 5 is a right side view of the melon stand;
FIG. 6 is a left side of the melon stand; and,
FIG. 7 is a perspective view of the melon stand.

1 Claim, 3 Drawing Sheets

- (56) **References Cited**
U.S. PATENT DOCUMENTS
1,635,376 A * 7/1927 McIlvaine A63B 57/10
473/388
D81,315 S * 6/1930 Mcleod D21/717

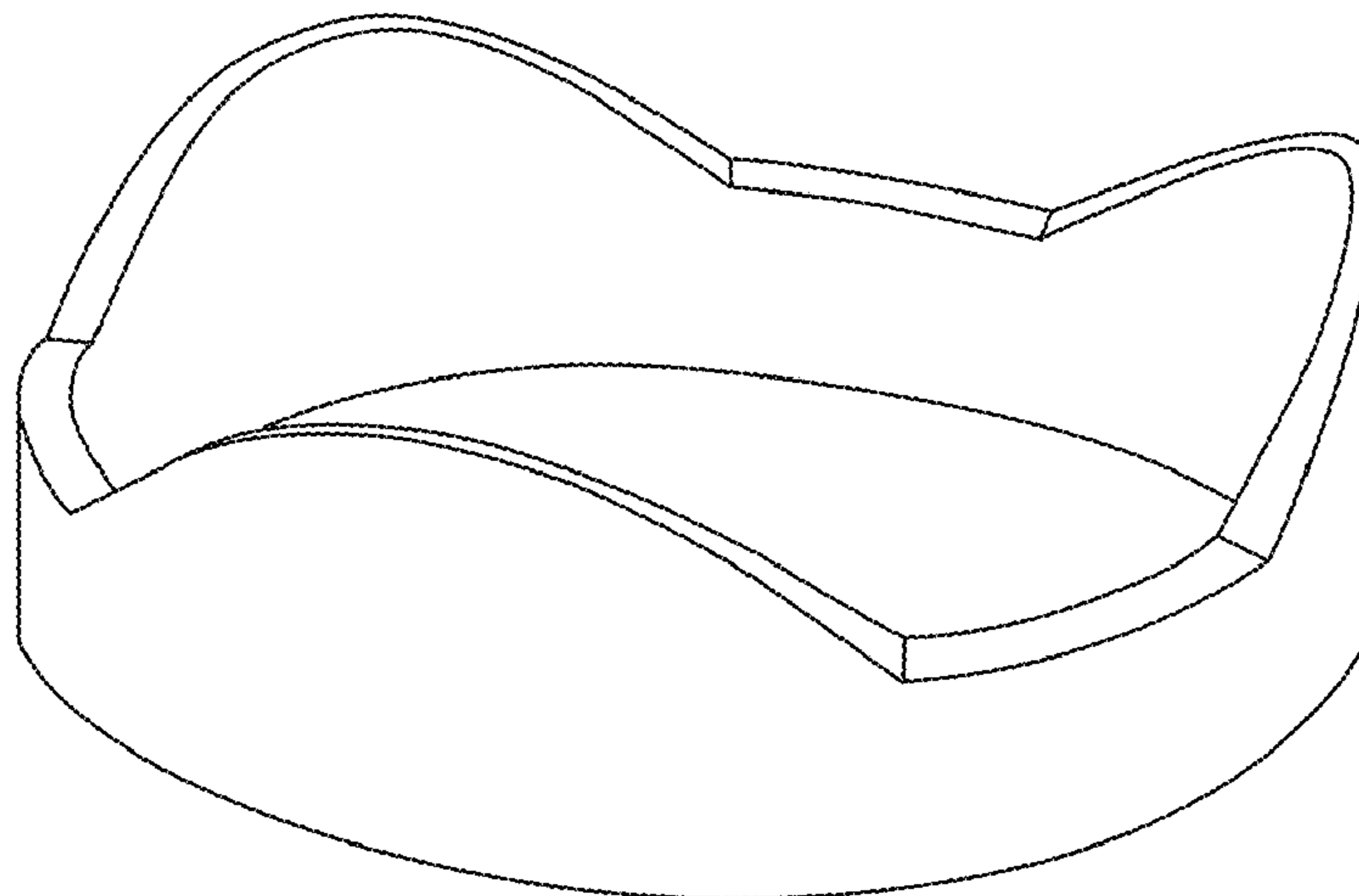

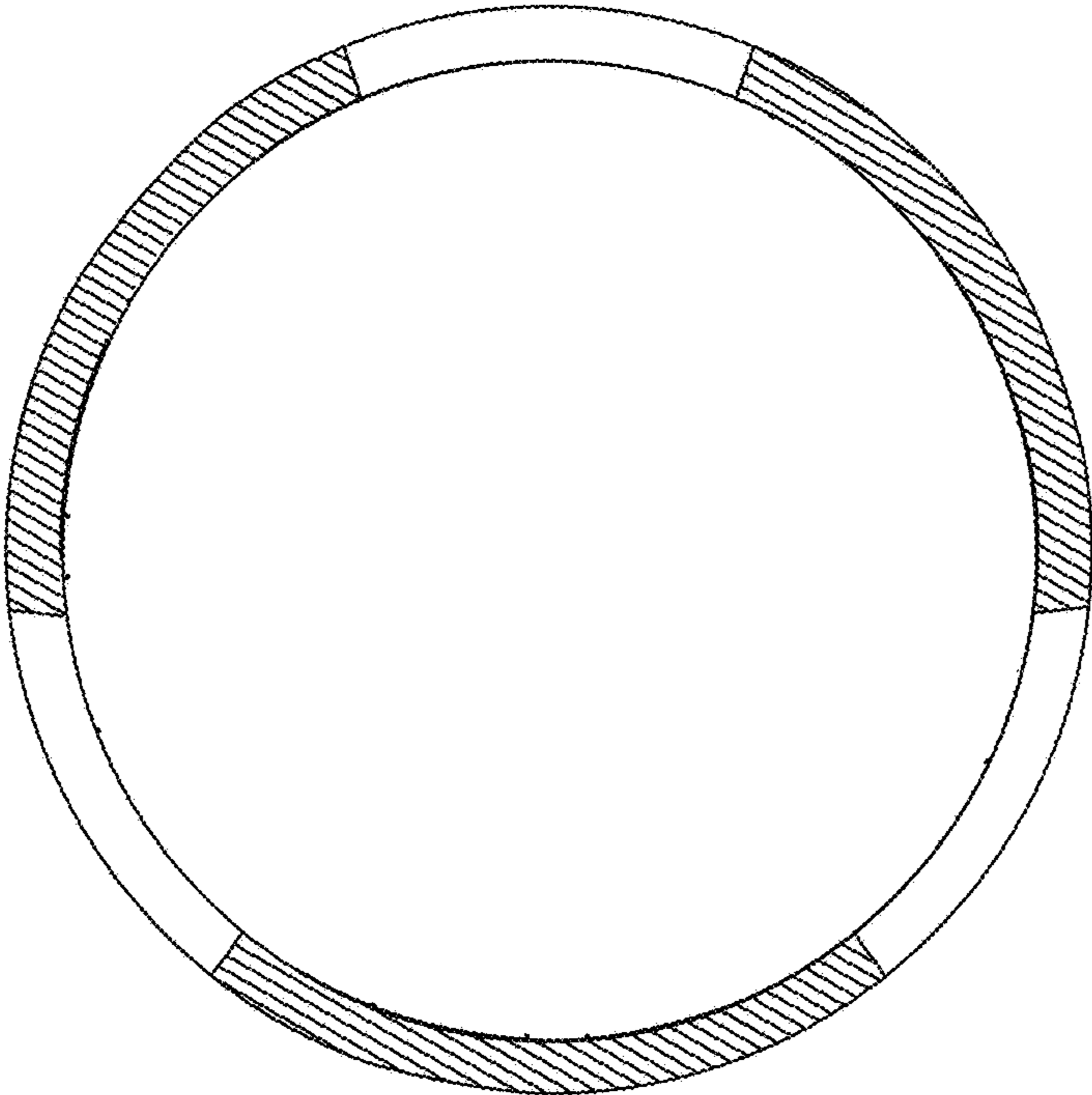

FIG. 1

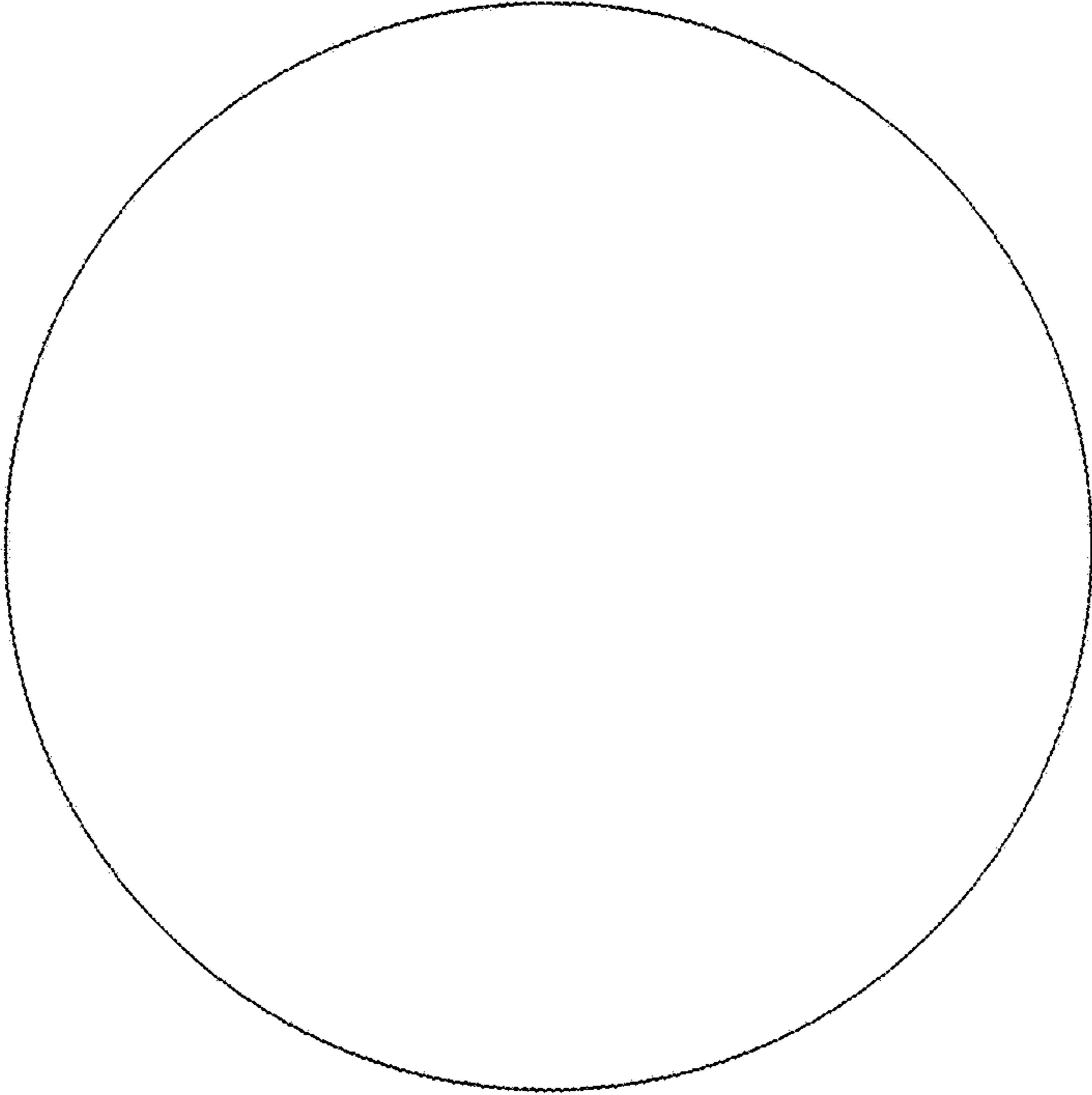

FIG. 2

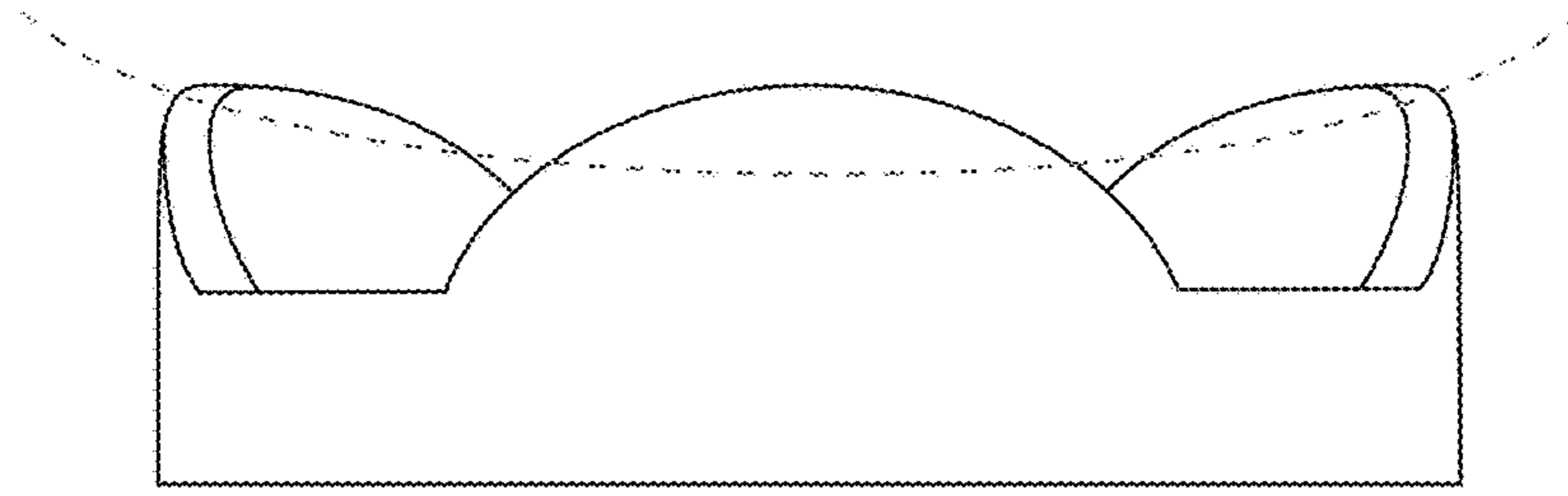

FIG. 3

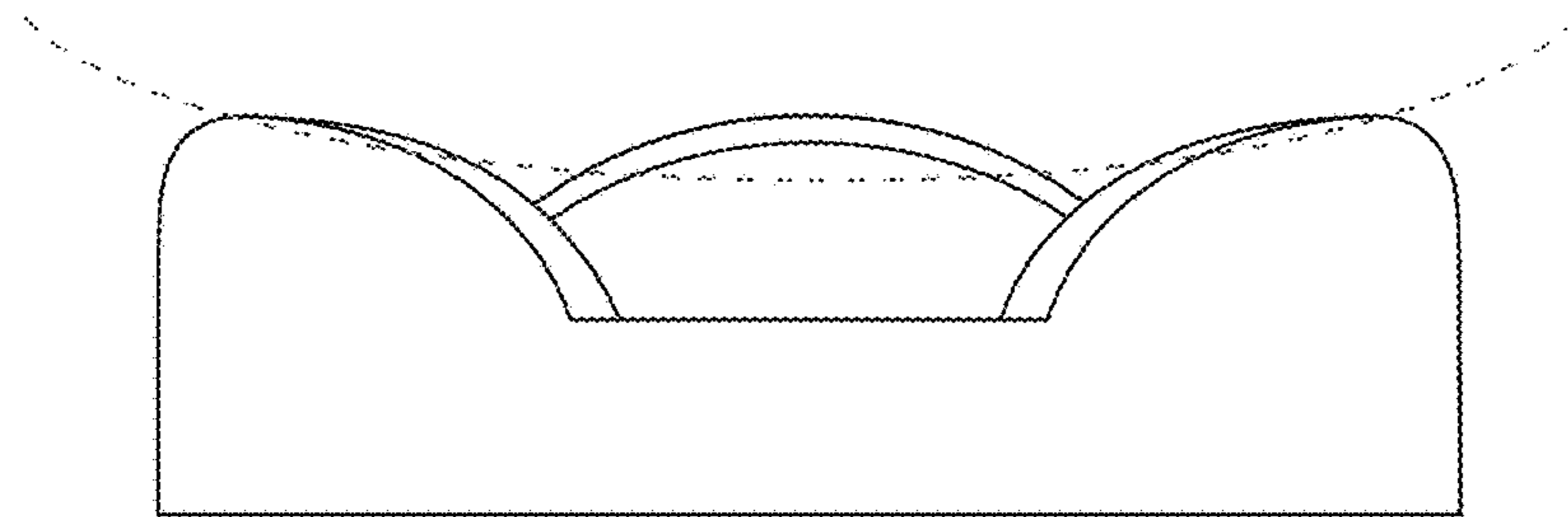

FIG. 4

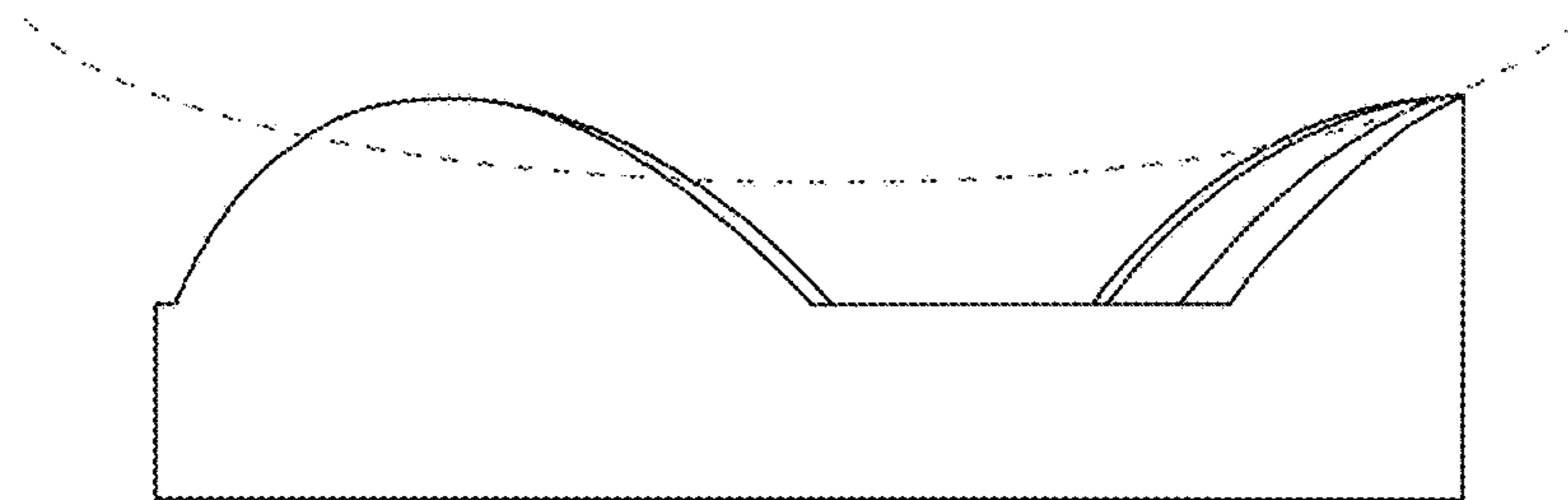

FIG. 5

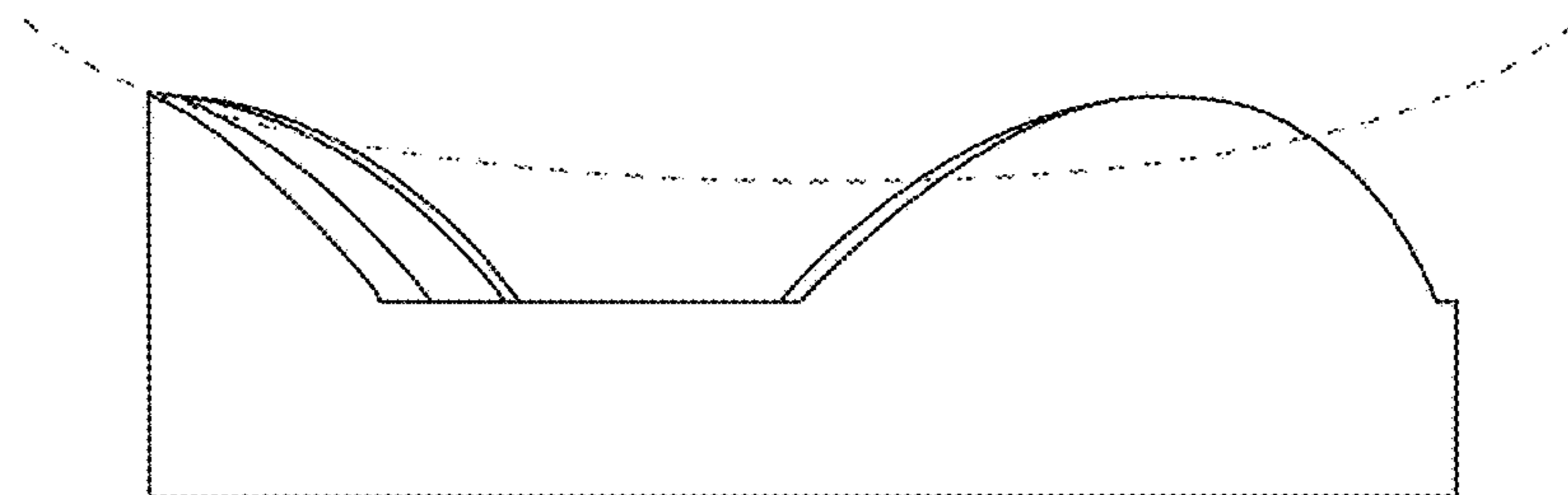

FIG. 6

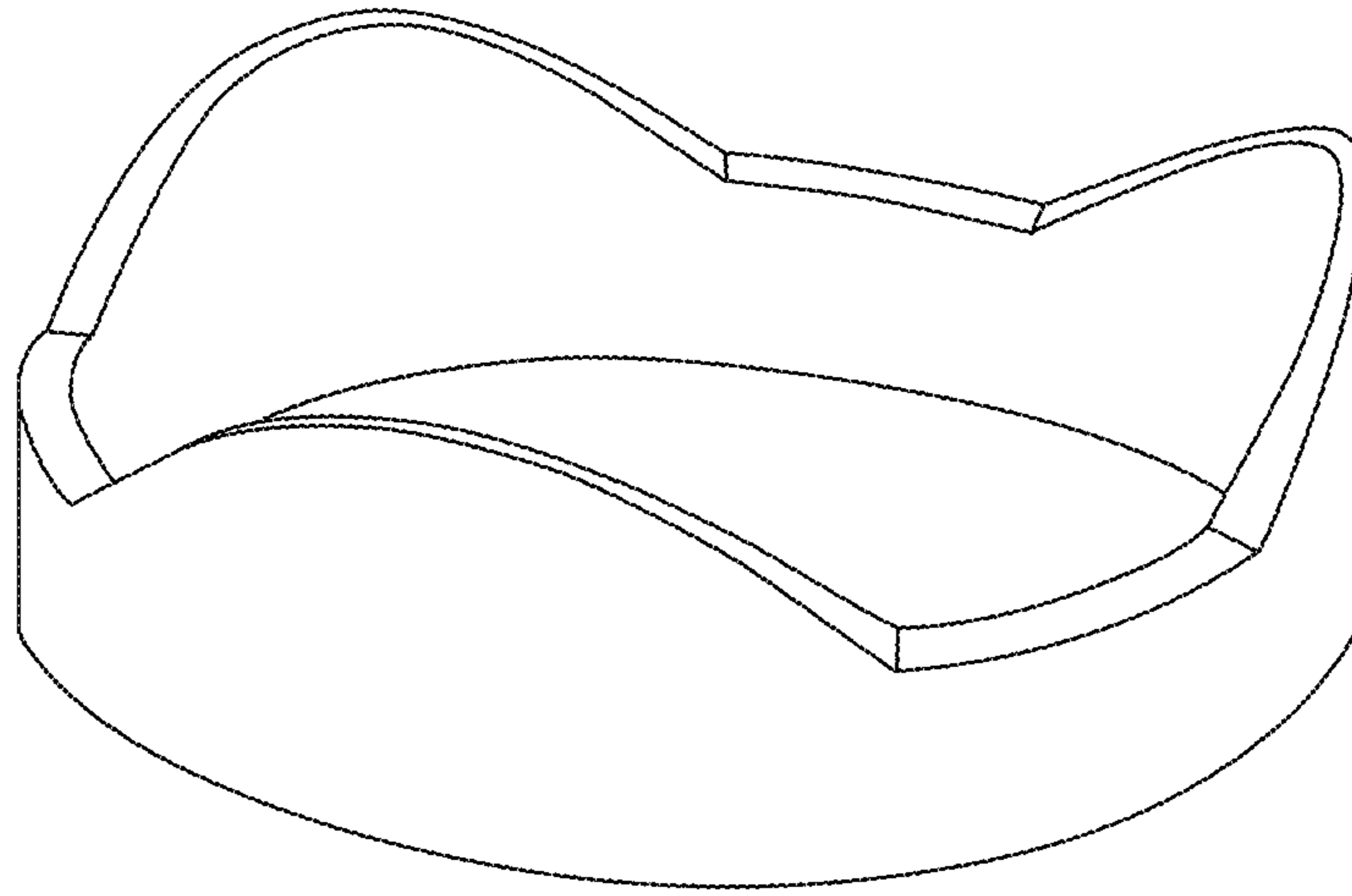

FIG. 7