



US00D785889S

(12) **United States Design Patent**  
**Arvinte et al.**

(10) **Patent No.:** **US D785,889 S**  
(45) **Date of Patent:** **\*\* May 2, 2017**

(54) **PAINT GRID**

D723,235 S \* 2/2015 Bergman ..... D32/53.1  
D740,509 S \* 10/2015 Bergman ..... D32/53.1

(71) Applicant: **A. RICHARD TOOLS CO.,**  
Berthierville (CA)

\* cited by examiner

(72) Inventors: **Roméo Arvinte**, Laval-des-Rapides  
(CA); **François Panfili**, Berthierville  
(CA)

*Primary Examiner* — Robin V Webster

(74) *Attorney, Agent, or Firm* — Merchant & Gould P.C.

(73) Assignee: **A, RICHARD TOOLS CO.,**  
Berthierville, Quebec (CA)

(57) **CLAIM**

(\*\*) Term: **15 Years**

The ornamental design for a paint grid, as shown and described.

(21) Appl. No.: **29/555,596**

(22) Filed: **Feb. 23, 2016**

(51) **LOC (10) Cl.** ..... **07-07**

(52) **U.S. Cl.**

USPC ..... **D32/54**

(58) **Field of Classification Search**

USPC ..... D32/53, 53.1, 54; 220/495.01, 495.02,  
220/495.06, 570, 904; 15/257.05, 257.06,  
15/264, 262

CPC ..... B65D 25/14; B65D 25/16; A47L 13/52;  
A47L 13/58; A47J 47/18; B44D 3/126

See application file for complete search history.

**DESCRIPTION**

FIG. 1 is a top perspective view of a paint grid;  
FIG. 2 a front perspective view thereof;  
FIG. 3 is a front view thereof;  
FIG. 4 is a rear view thereof;  
FIG. 5 is a left-side view thereof;  
FIG. 6 is a right-side view thereof;  
FIG. 7 is a top view thereof;  
FIG. 8 is a bottom view thereof; and,  
FIG. 9 is a top perspective view of the paint grid shown  
cooperating with a paint container.  
The portions shown in broken lines form no part of the  
claimed design.

(56) **References Cited**

**U.S. PATENT DOCUMENTS**

D264,147 S \* 5/1982 Heath ..... D32/54  
5,283,928 A \* 2/1994 Linn ..... B44D 3/128  
15/257.05

**1 Claim, 7 Drawing Sheets**

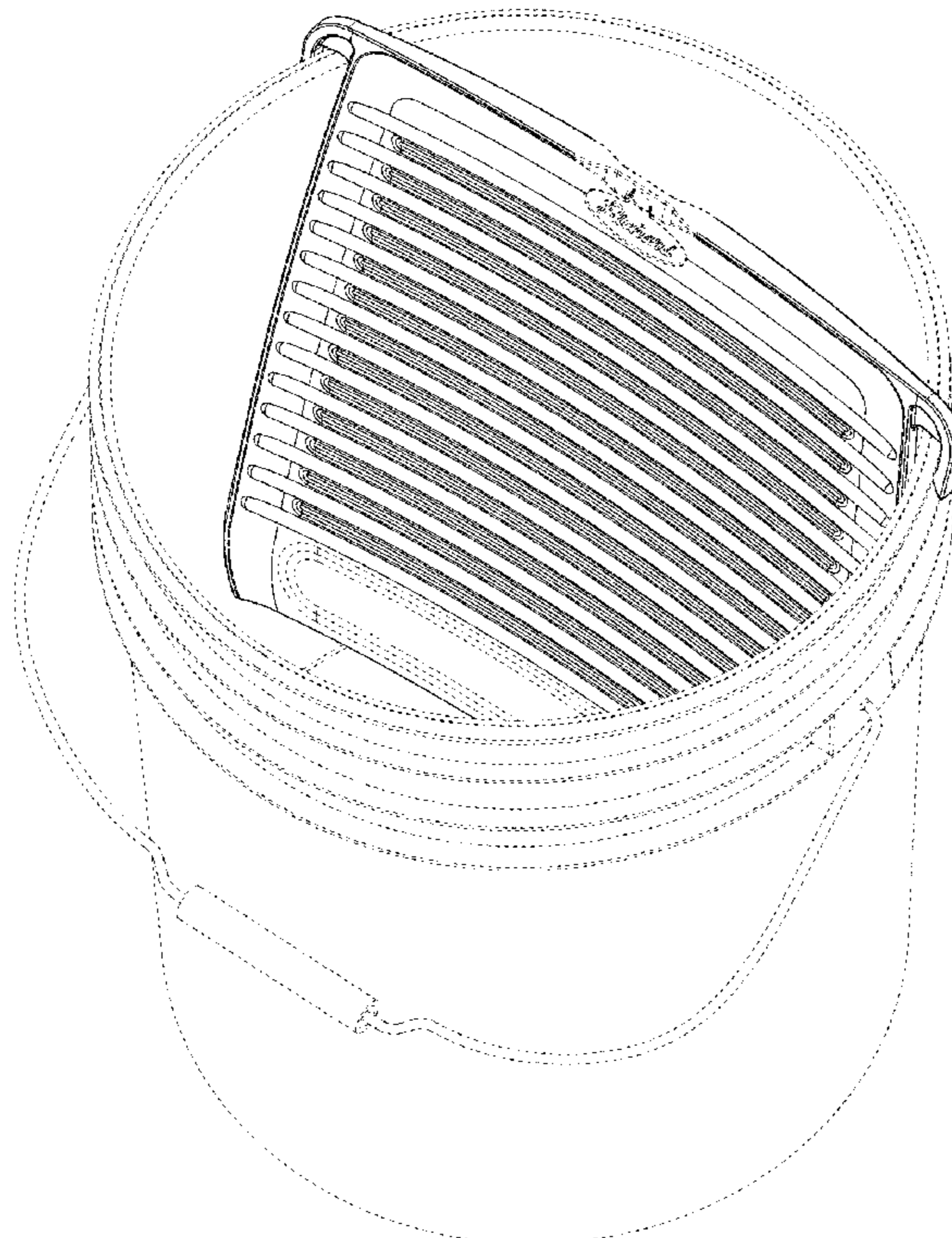

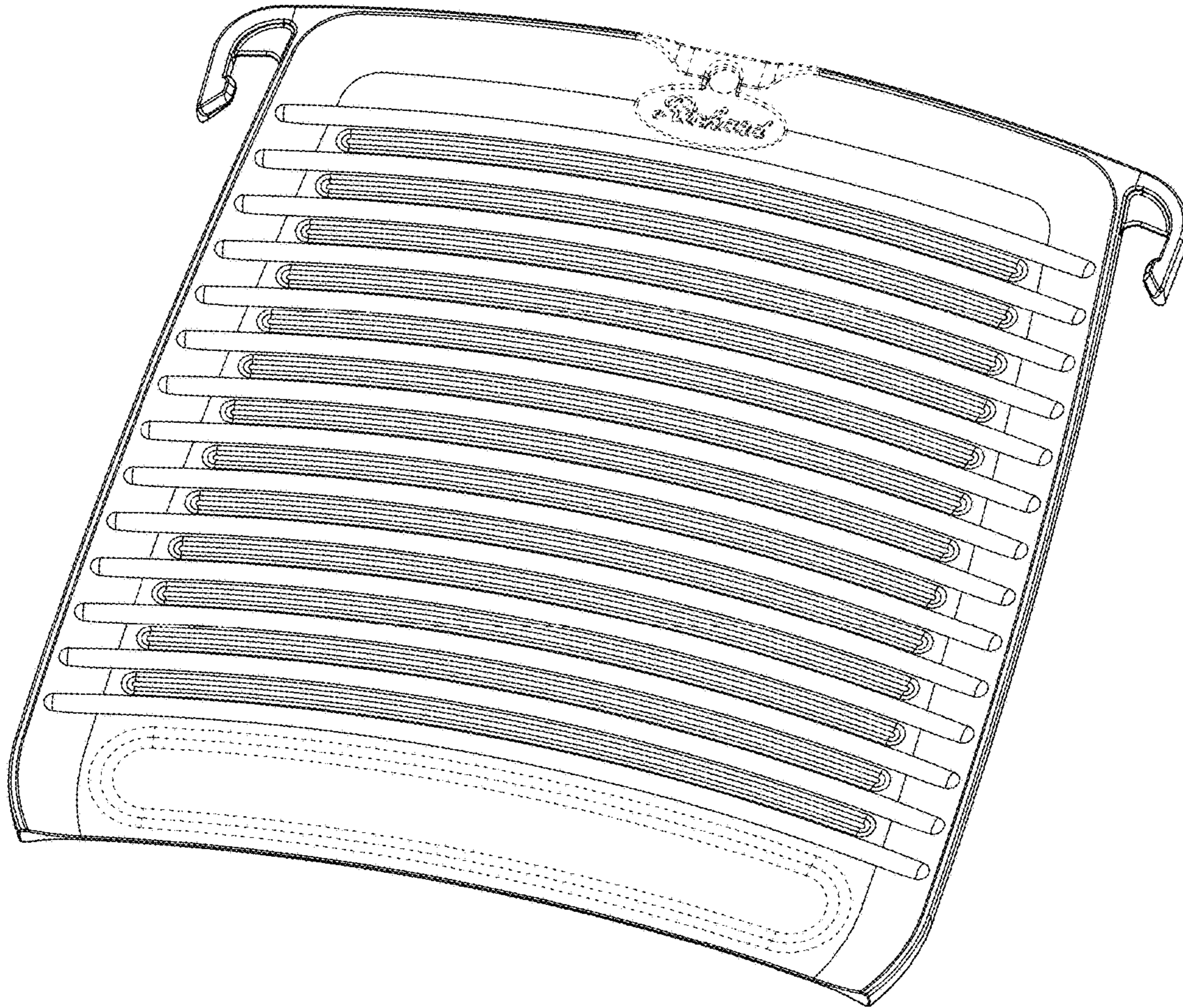

FIG. 1

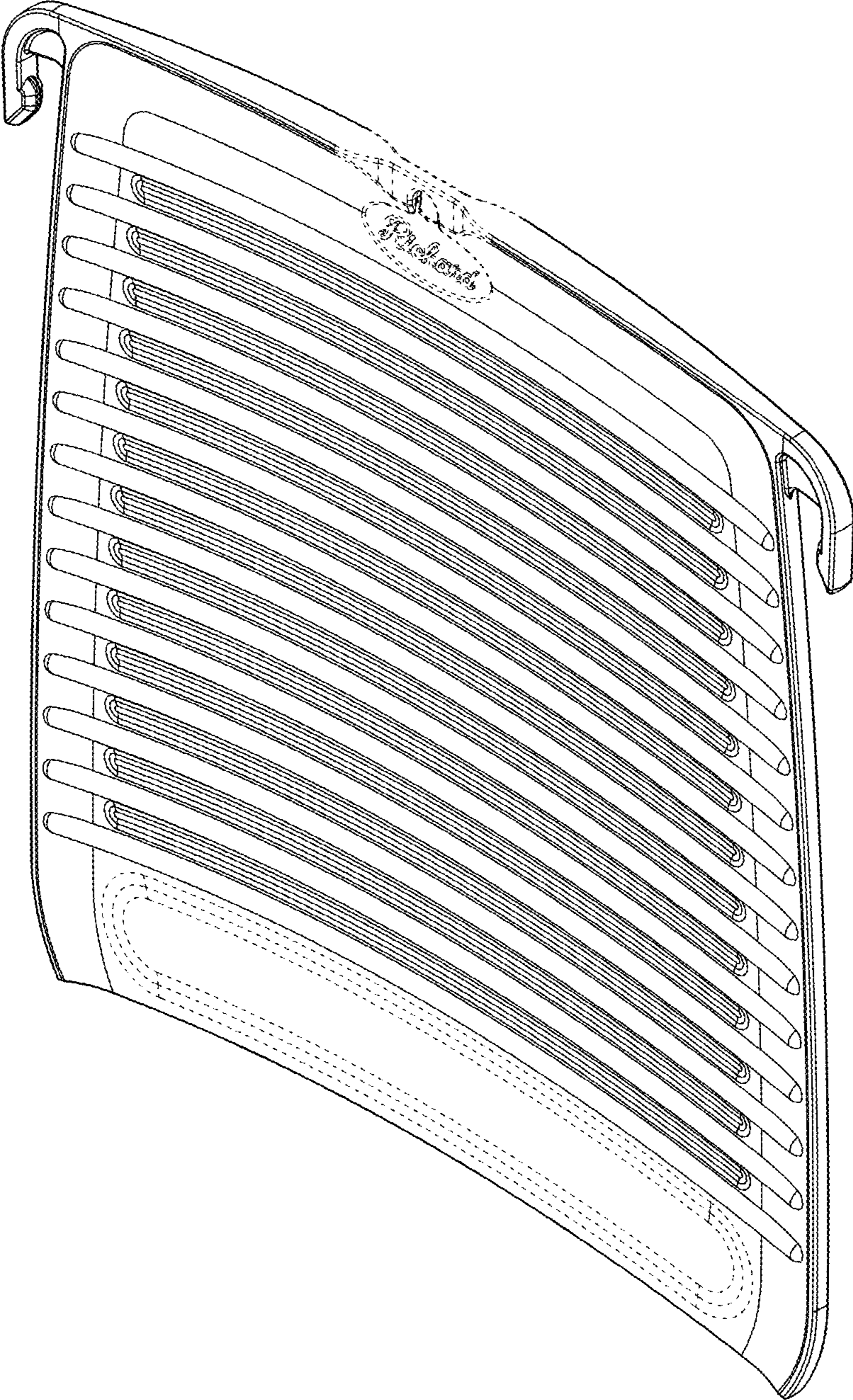

FIG. 2

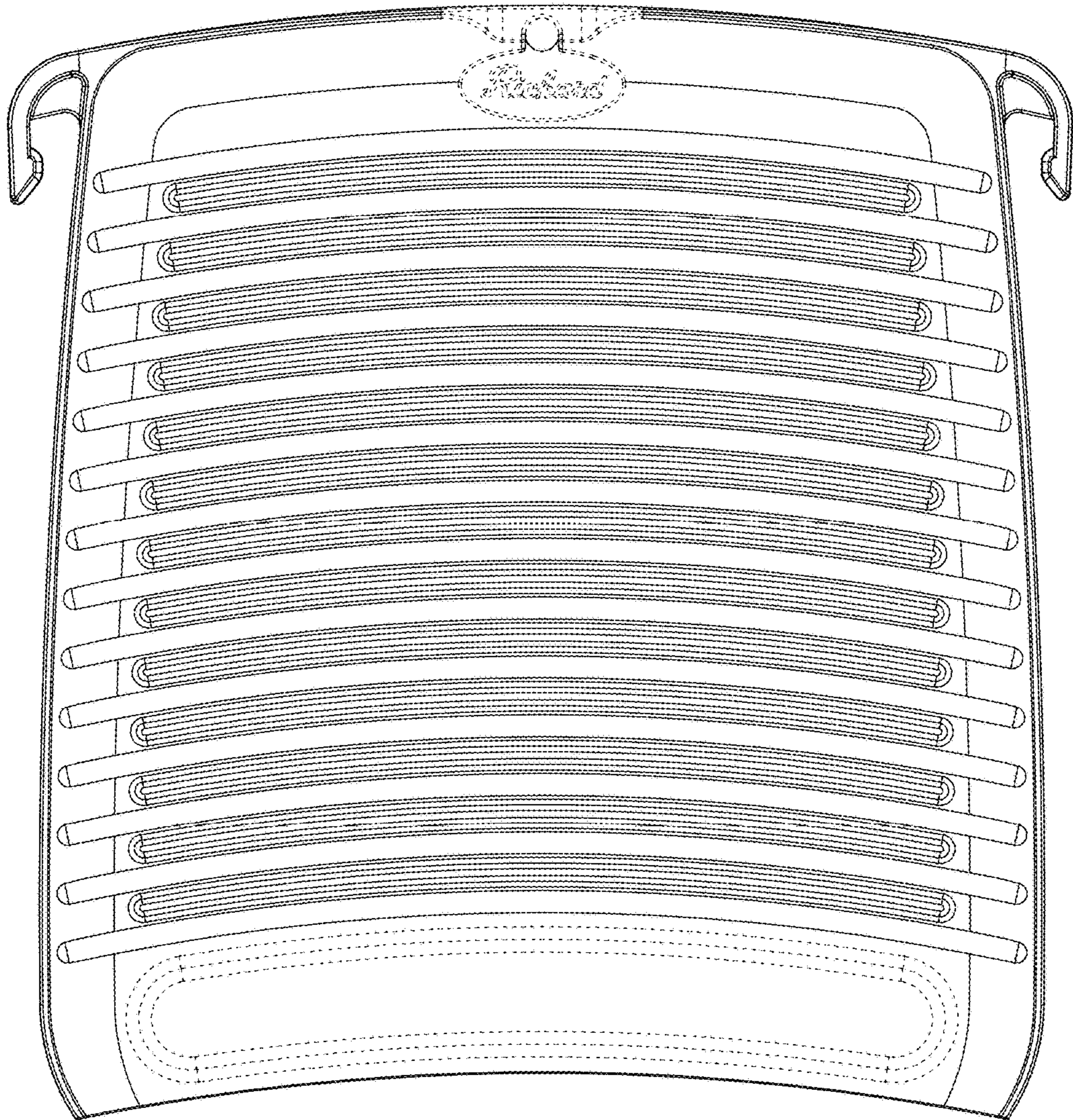

FIG. 3

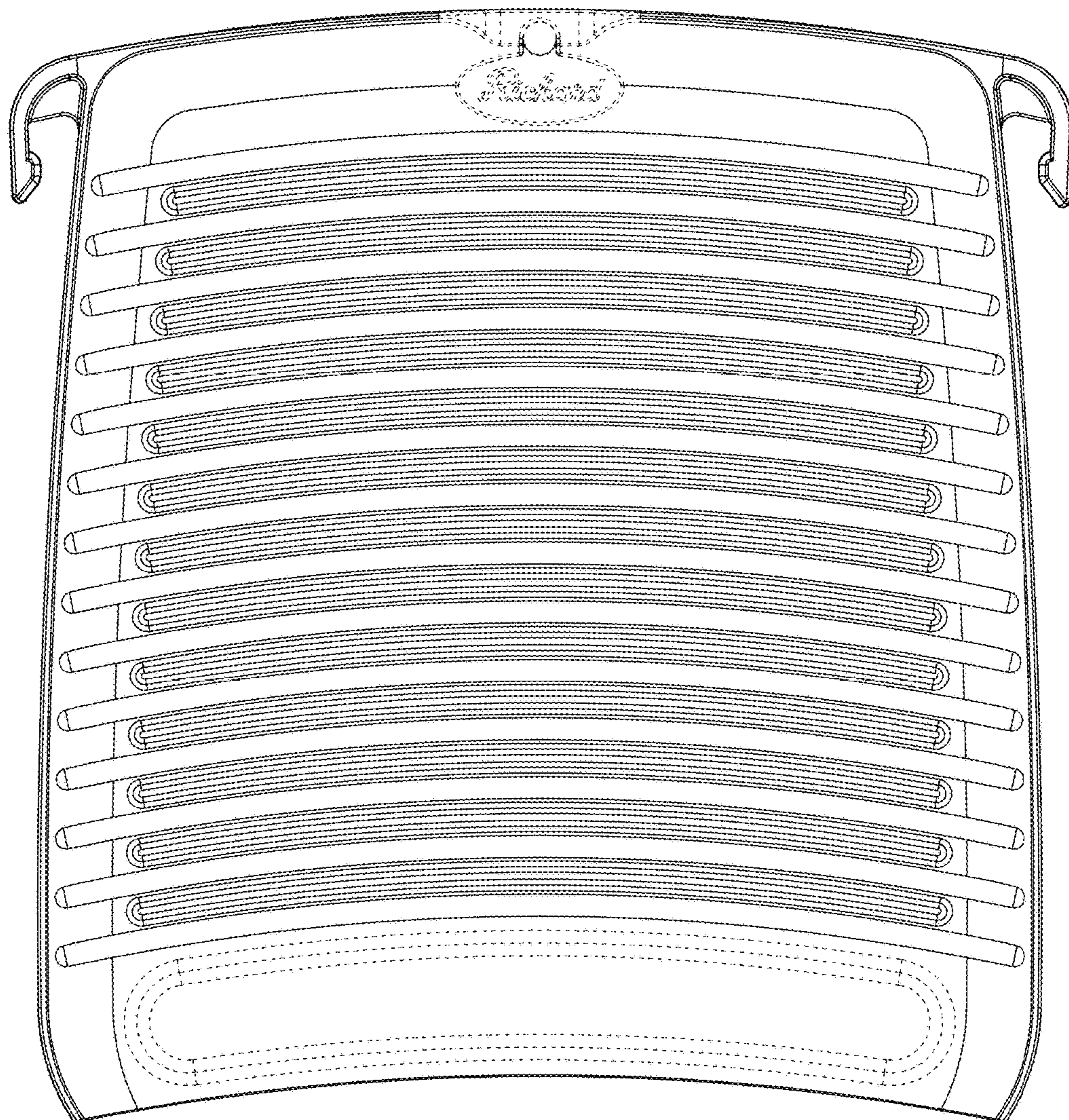

FIG. 4

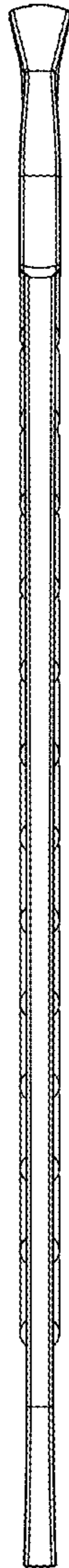

FIG. 5

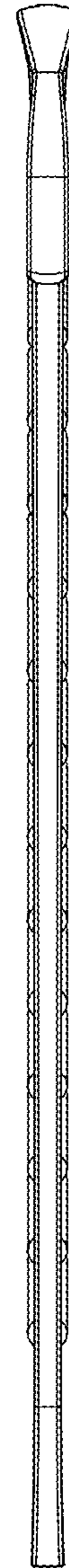

FIG. 6

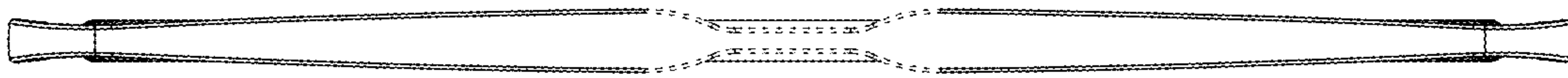

FIG. 7

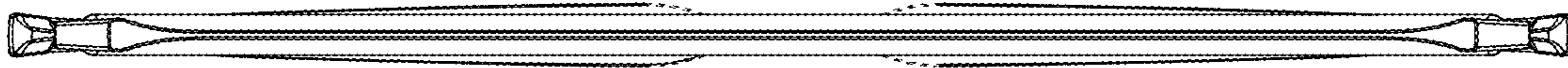

FIG. 8

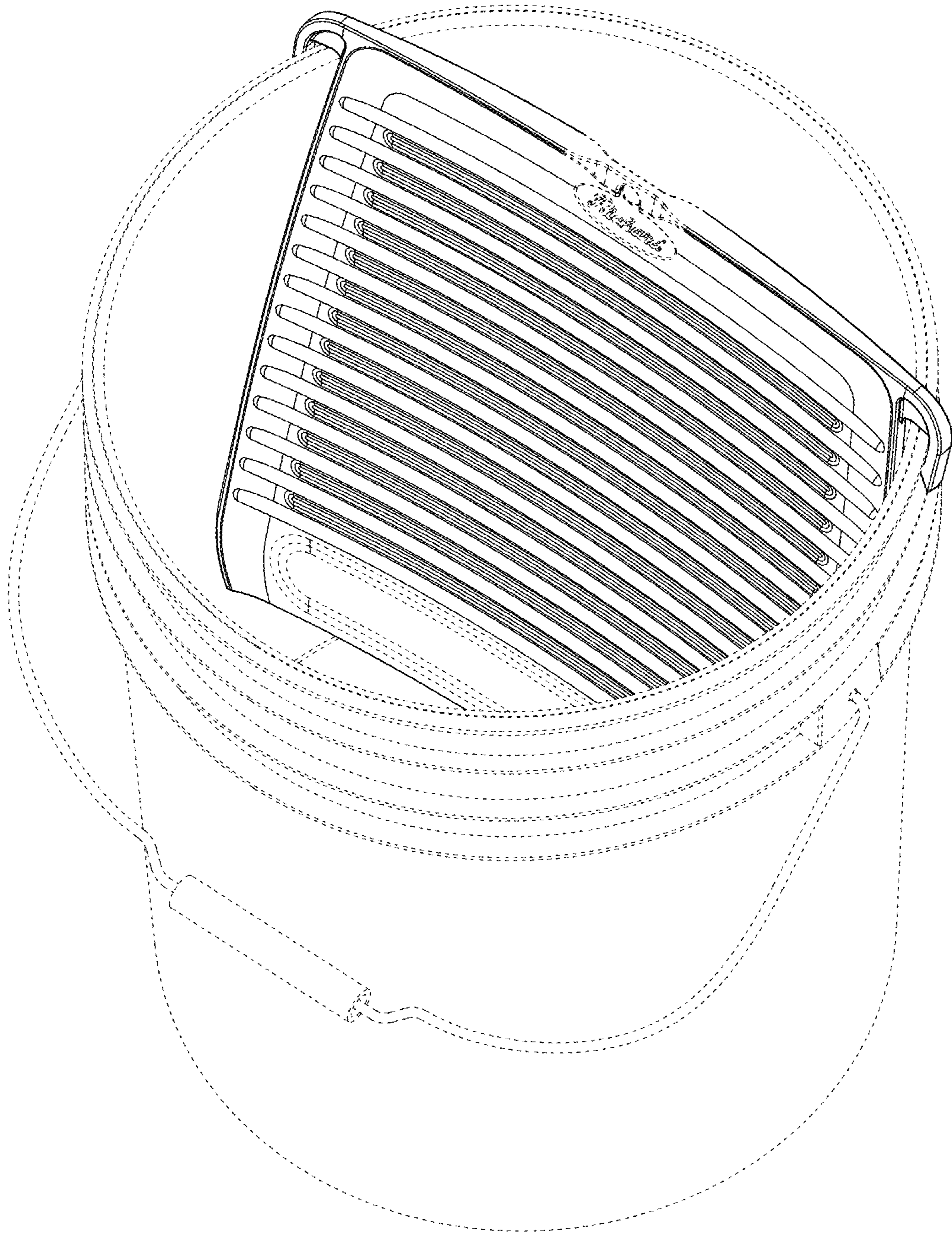

FIG. 9