



US00D785849S

(12) **United States Design Patent** (10) **Patent No.:** **US D785,849 S**
Sites (45) **Date of Patent:** **** May 2, 2017**

(54) **SOLAR POWERED ILLUMINATED FIGURE**

(71) Applicant: **Michael Sites**, Hayes, VA (US)

(72) Inventor: **Michael Sites**, Hayes, VA (US)

(**) Term: **15 Years**

(21) Appl. No.: **29/552,936**

(22) Filed: **Jan. 27, 2016**

(51) **LOC (10) Cl.** **26-03**

(52) **U.S. Cl.**
USPC **D26/94**

(58) **Field of Classification Search**
USPC D26/60-66, 72, 87, 92, 85, 93, 94, 102,
D26/104; D11/96, 157; D99/27;
D13/102

CPC F21S 4/00; F21S 6/00; F21S 6/002; F21S
6/004; F21S 8/043; F21S 8/08; F21V
14/00; F21V 21/00; F21V 21/116; F21V
21/14; F21V 21/34; F21W 2131/30
See application file for complete search history.

(56) **References Cited**

U.S. PATENT DOCUMENTS

2,771,543 A 11/1956 Seisholtz, Jr.
D300,079 S * 2/1989 Smith D11/96

4,816,970 A 3/1989 Garcia, Jr.
5,225,170 A * 7/1993 Kolk A47B 83/001
118/620
D338,081 S 8/1993 Klaffer
D338,633 S * 8/1993 Andre D11/96
5,255,170 A 10/1993 Plamp et al.
5,564,816 A 10/1996 Arcadia et al.
D456,556 S * 4/2002 Pahl D26/94
D518,754 S * 4/2006 Dias D11/96
7,125,138 B2 10/2006 Reinmann
2007/0079535 A1 4/2007 Newton

* cited by examiner

Primary Examiner — Brian N Vinson

(57) **CLAIM**

The ornamental design for a solar powered illuminated figure, as shown and described.

DESCRIPTION

FIG. 1 is a front view of a solar powered illuminated figure showing my new design;
FIG. 2 is a rear view of the solar powered illuminated figure;
FIG. 3 is a left side view of the solar powered illuminated figure, a right side view being a mirror image thereof;
FIG. 4 is a top view of the solar powered illuminated figure;
and,
FIG. 5 is a bottom view of the solar powered illuminated figure.

1 Claim, 4 Drawing Sheets

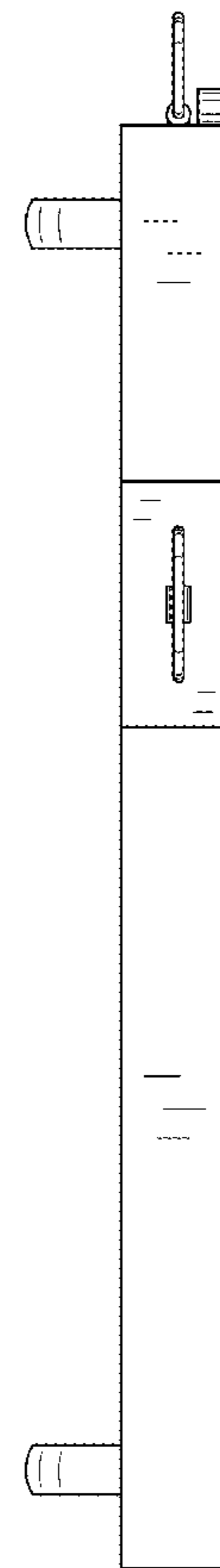
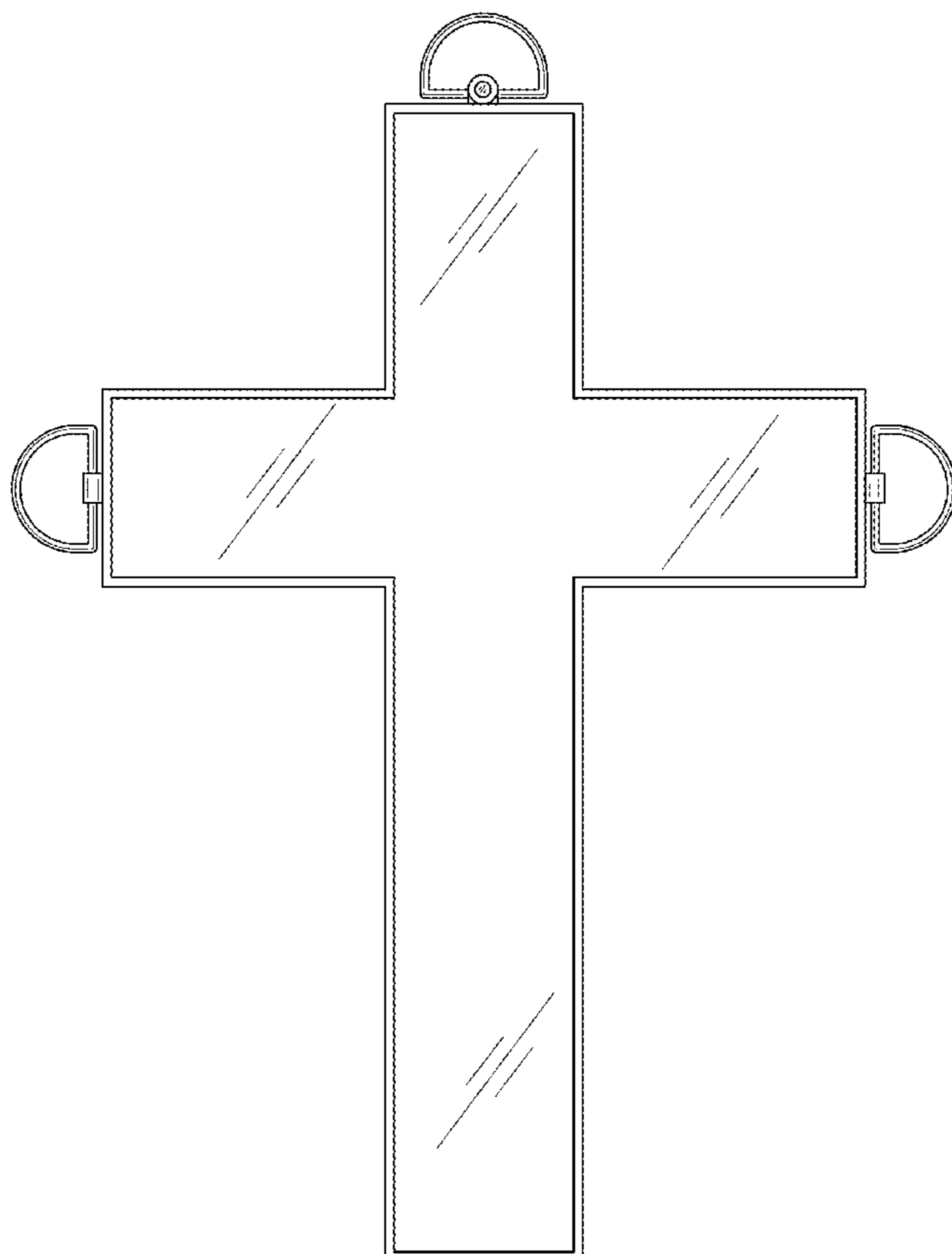

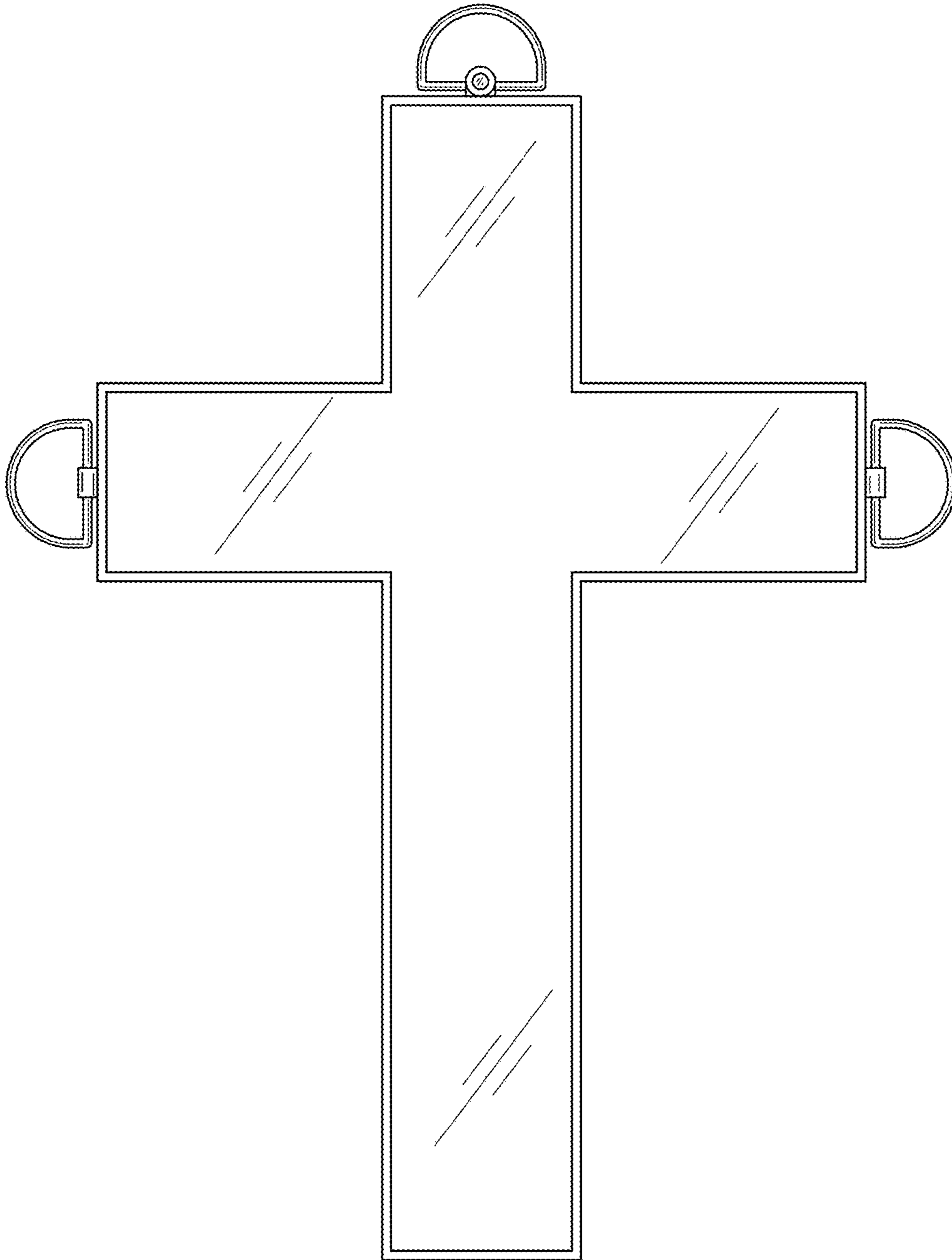

FIG. 1

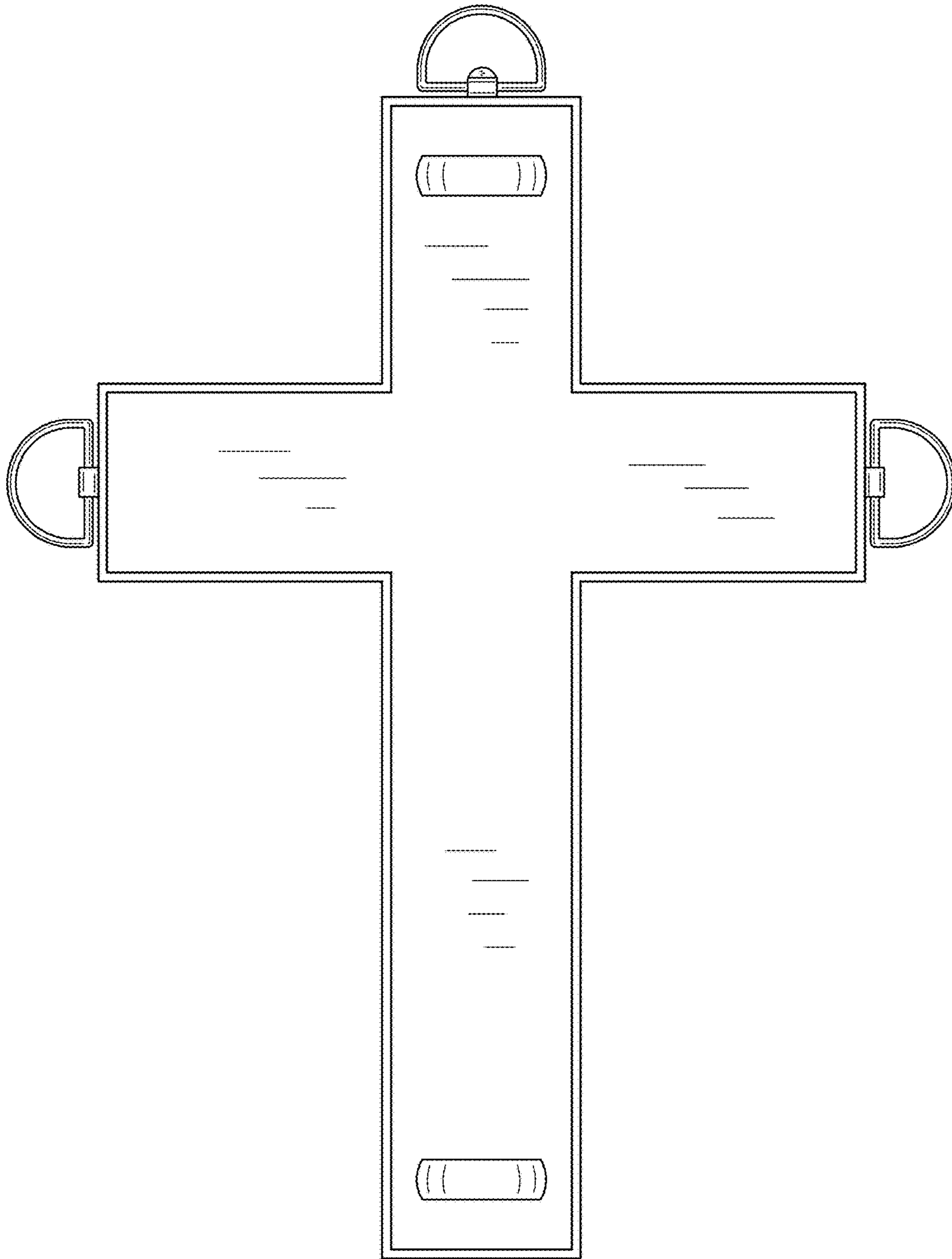

FIG. 2

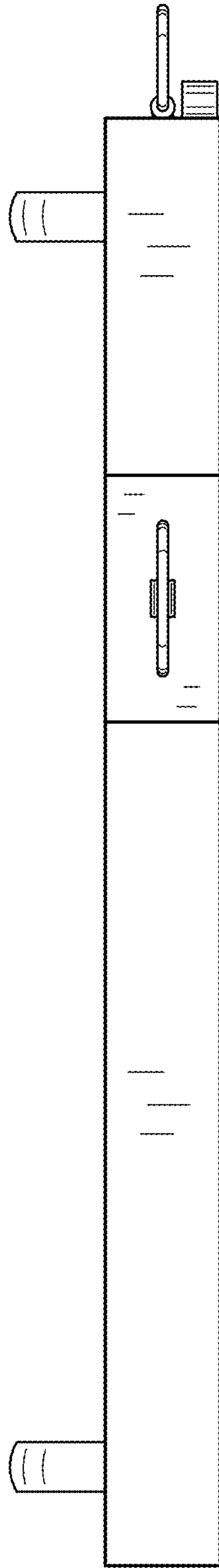

FIG. 3

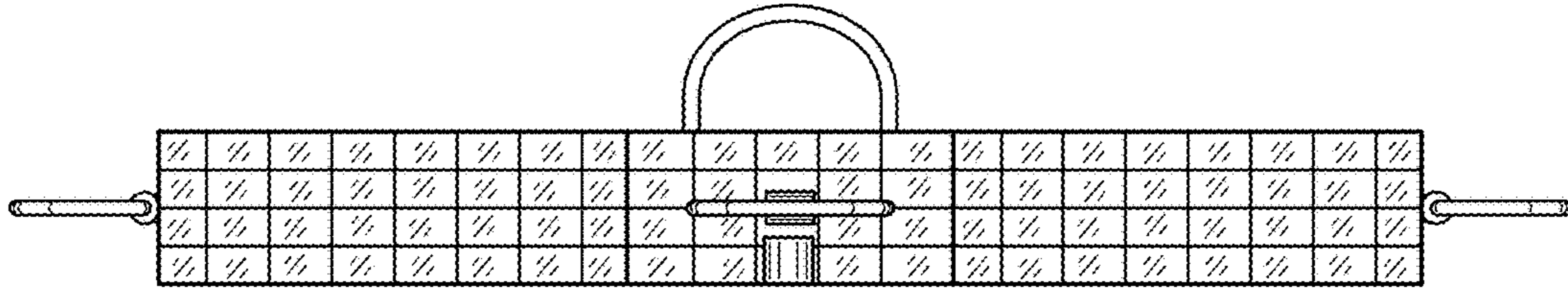

FIG. 4

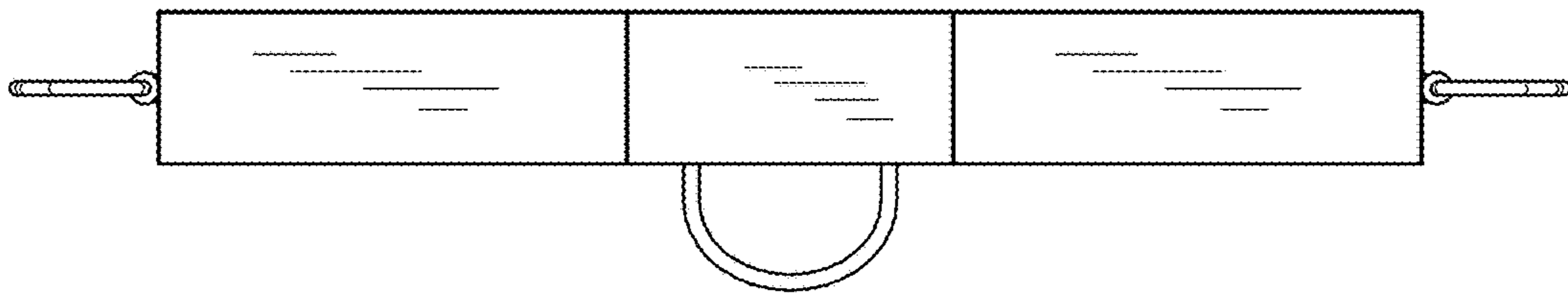

FIG. 5