



US00D785749S

(12) **United States Design Patent** (10) **Patent No.:** **US D785,749 S**
Kano et al. (45) **Date of Patent:** **** May 2, 2017**

(54) **FISHING REEL**

(56) **References Cited**

(71) Applicant: **GLOBERIDE, INC.**,
Higashikurume-shi, Tokyo (JP)
(72) Inventors: **Shuta Kano**, Higashikurume (JP);
Masakazu Noguchi, Higashikurume
(JP); **Daisuke Higuchi**, Musashino (JP)

U.S. PATENT DOCUMENTS

D501,528 S * 2/2005 Nago D22/140
D504,491 S * 4/2005 Iwabuchi D22/140
D561,870 S * 2/2008 Myojo D22/141

* cited by examiner

(73) Assignee: **GLOBERIDE, INC.**, Tokyo (JP)

Primary Examiner — Catheri Oliver-Garcia

(**) Term: **15 Years**

(74) *Attorney, Agent, or Firm* — Sughrue Mion, PLLC

(21) Appl. No.: **29/555,874**

(57) **CLAIM**

The ornamental design for a fishing reel, as shown and described.

(22) Filed: **Feb. 25, 2016**

DESCRIPTION

(30) **Foreign Application Priority Data**

Aug. 31, 2015 (JP) 2015-019226

(51) **LOC (10) Cl.** **22-05**

(52) **U.S. Cl.**
USPC **D22/140**

(58) **Field of Classification Search**
USPC D22/137-140; 43/20-24; 242/234-240,
242/263, 279, 283, 310-312, 314,
242/316-317, 319, 323
CPC A01K 89/015; A01K 89/033
See application file for complete search history.

FIG. 1 is a front, right, upper perspective view of a fishing reel showing our new design;
FIG. 2 is a rear, left, upper perspective view thereof;
FIG. 3 is a front view thereof;
FIG. 4 is a rear view thereof;
FIG. 5 is a left side view thereof;
FIG. 6 is a right side view thereof;
FIG. 7 is a top plan view thereof; and,
FIG. 8 is a bottom plan view thereof.
The broken lines represent the unclaimed portions of the fishing reel and form no part of the claimed design.

1 Claim, 4 Drawing Sheets

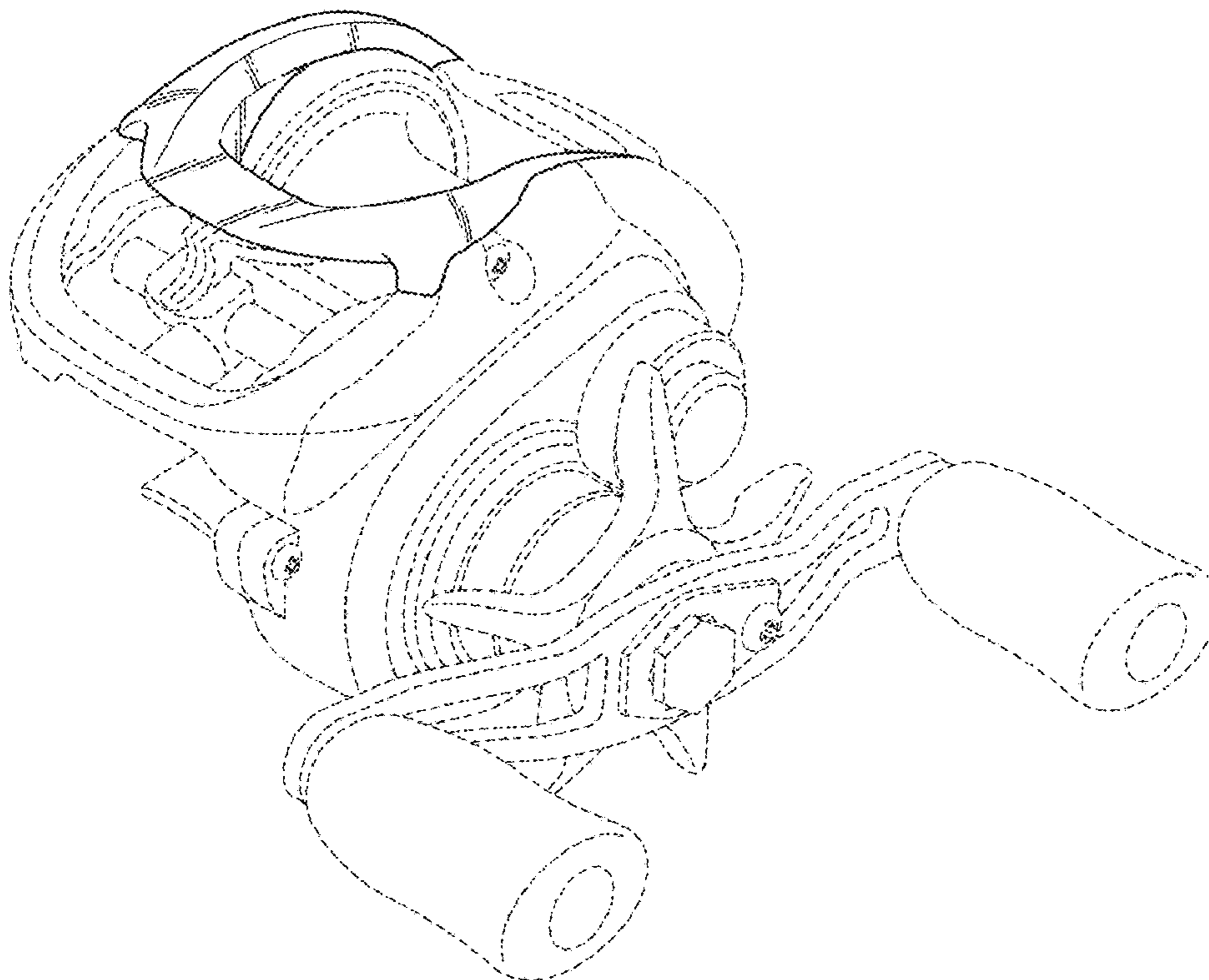

FIG. 1

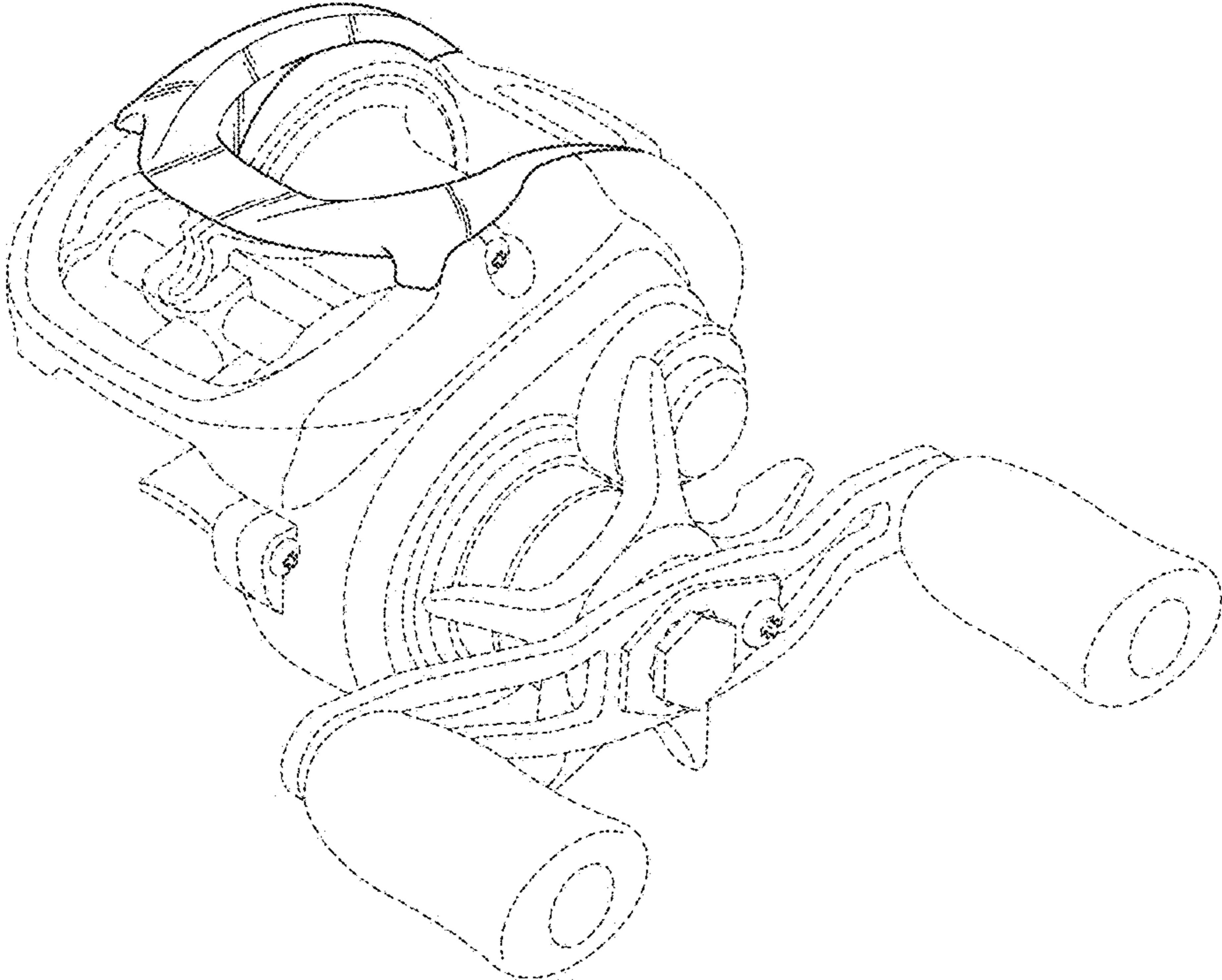

FIG. 2

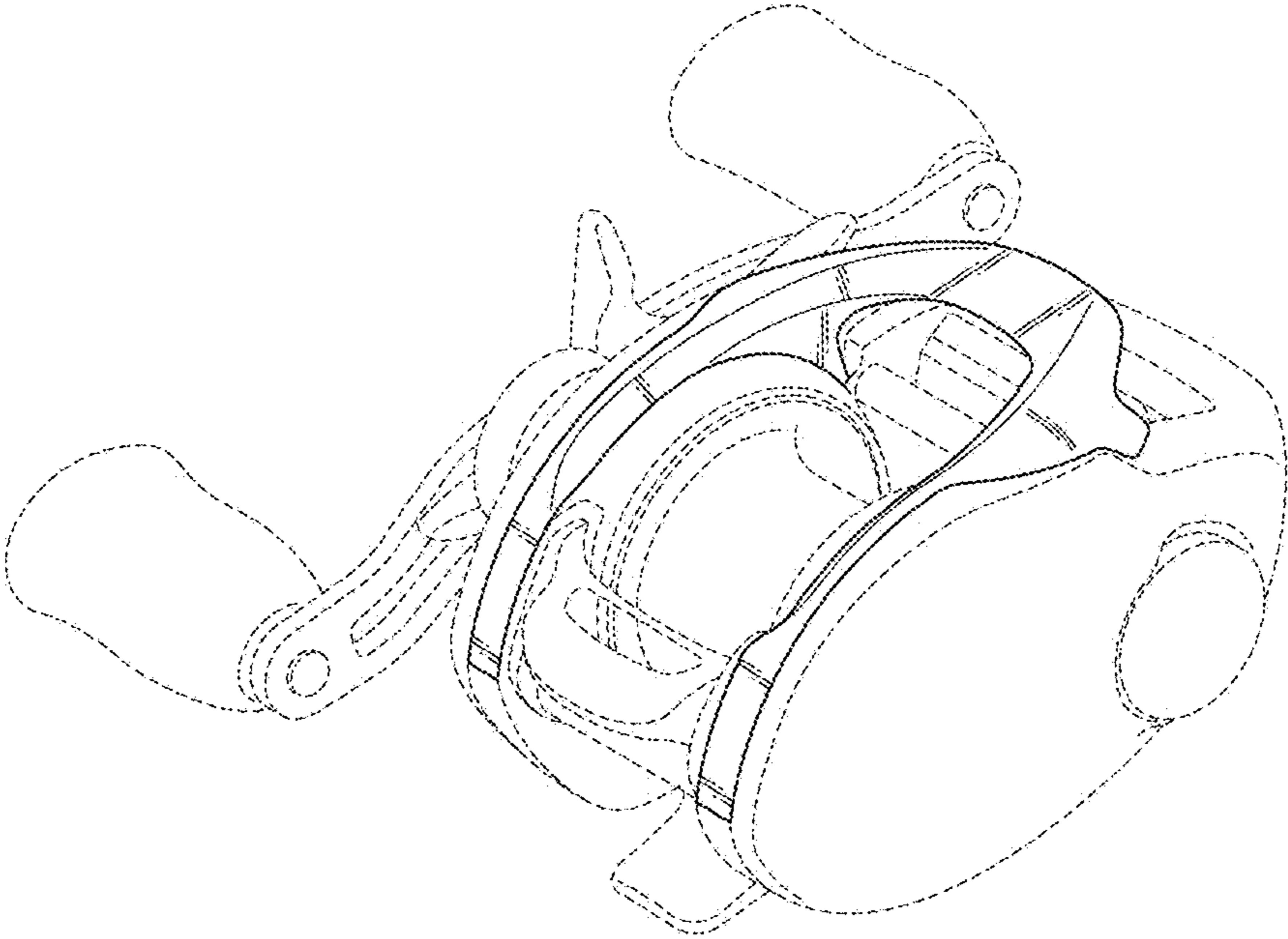

FIG. 3

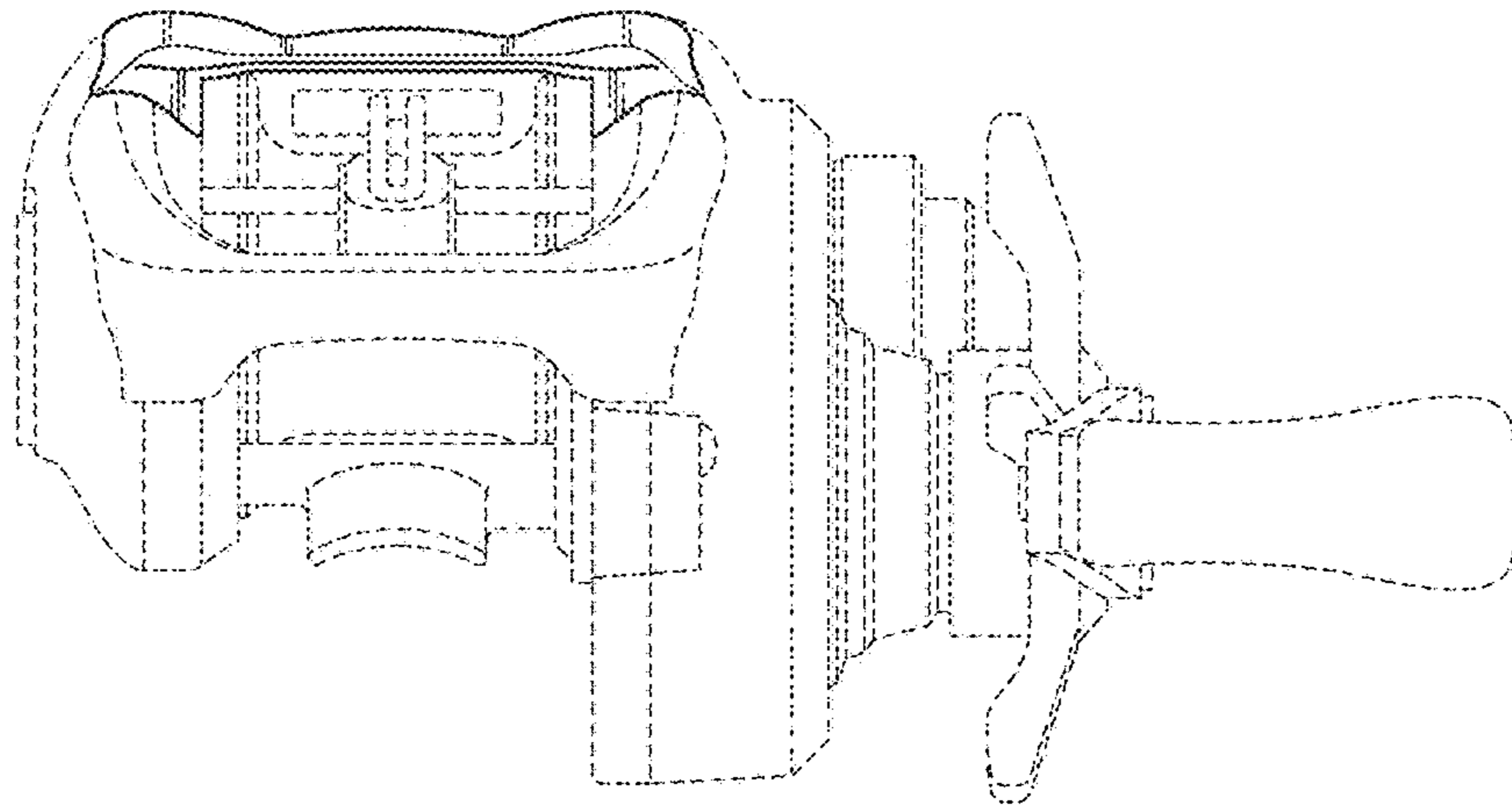

FIG. 4

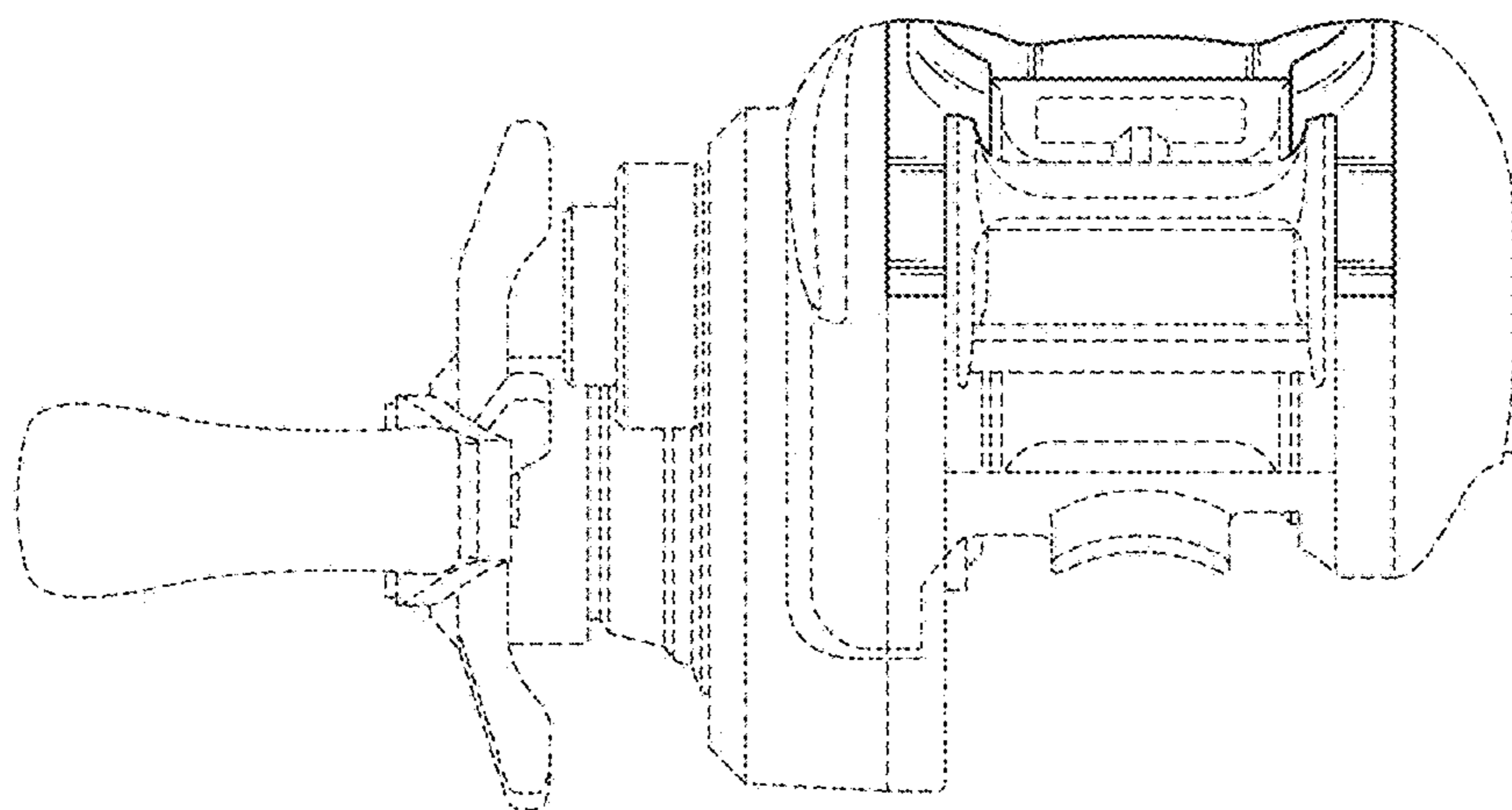

FIG. 5

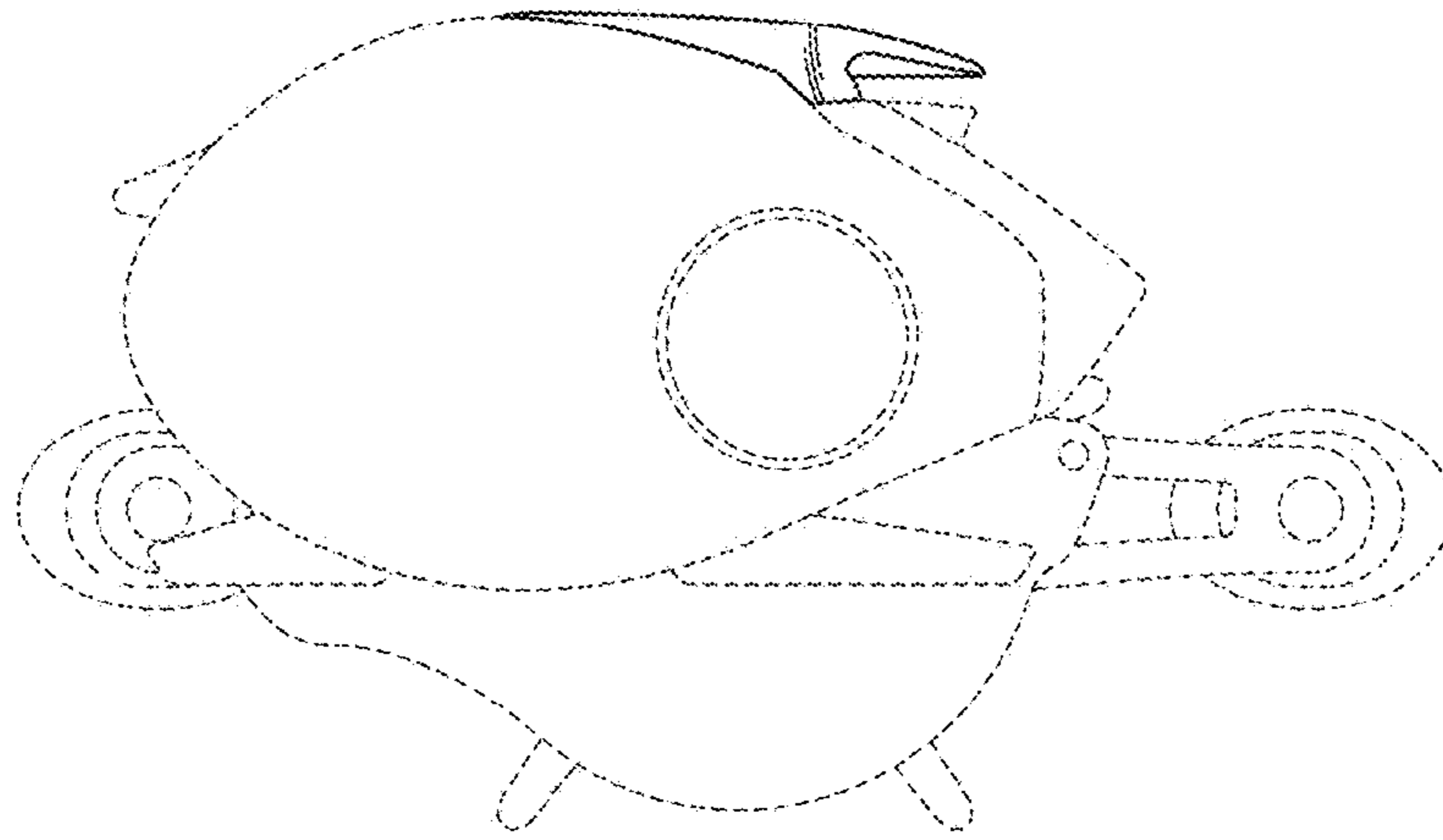

FIG. 6

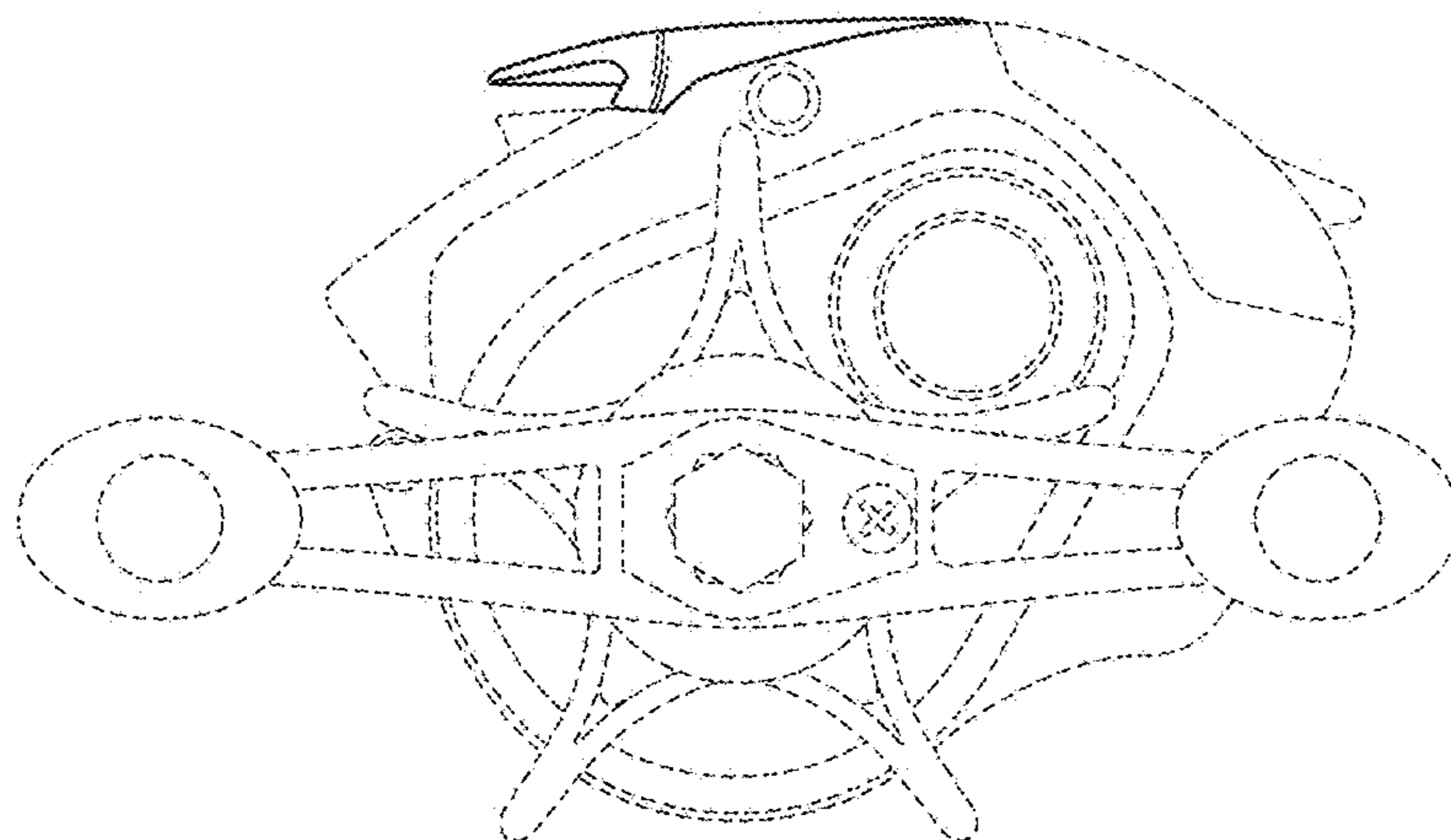

FIG. 7

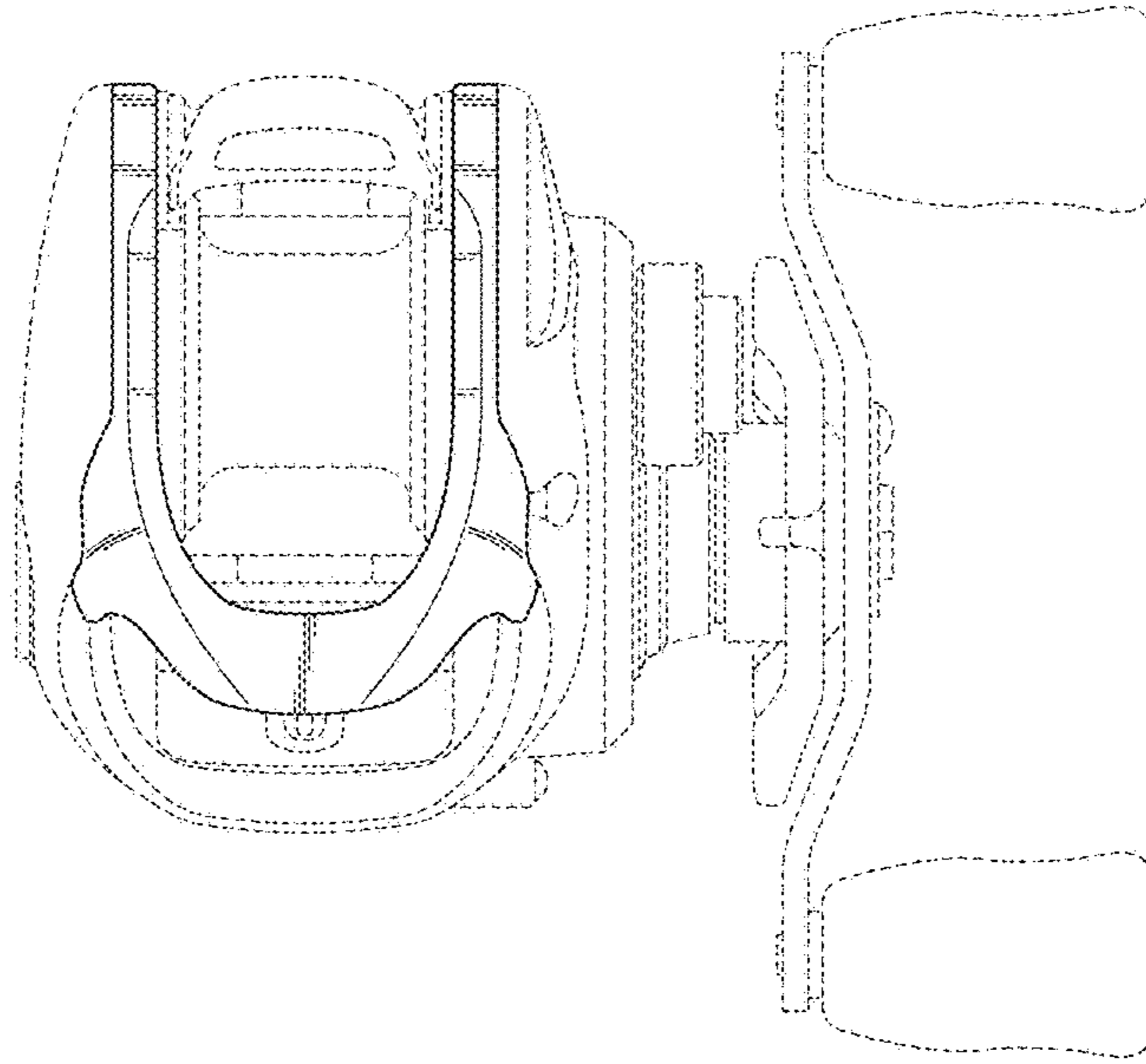

FIG. 8

