



US00D785670S

(12) **United States Design Patent**  
**Vallat et al.**

(10) **Patent No.:** **US D785,670 S**  
(45) **Date of Patent:** **\*\* May 2, 2017**

(54) **DISPLAY SCREEN OR PORTION THEREOF WITH ANIMATED GRAPHICAL USER INTERFACE**

(71) Applicant: **Tata Consultancy Services Limited**,  
Maharashtra (IN)

(72) Inventors: **Sathish Vallat**, Karnataka (IN); **Nitin Kumar**, Karnataka (IN); **Harini Ramachandraiah**, Karnataka (IN); **Nikhil Sahoo**, Karnataka (IN); **Annie Thomas**, Karnataka (IN); **Shalin Garg**, Karnataka (IN); **Shikha Tomar**, Karnataka (IN)

(73) Assignee: **Tata Consultancy Services Limited**,  
Maharashtra (IN)

(\*\*) Term: **15 Years**

(21) Appl. No.: **29/547,654**

(22) Filed: **Dec. 7, 2015**

(51) **LOC (10) Cl.** ..... **14-04**

(52) **U.S. Cl.**  
USPC ..... **D14/488**; D14/493

(58) **Field of Classification Search**  
USPC ..... D14/485-95; D18/24-33; D19/6, 52, 1;  
D20/11; D21/324-33; 715/700-867,  
715/973-77; D5/30

(Continued)

(56) **References Cited**

**U.S. PATENT DOCUMENTS**

1,819,753 A \* 8/1931 Morris ..... A47K 10/427  
221/58  
2,725,651 A \* 12/1955 Spear ..... B42D 15/042  
40/124.13

(Continued)

**OTHER PUBLICATIONS**

Trademark applications serial Nos. 78678152, 85680870.\*

*Primary Examiner* — Melanie H Tung

(74) *Attorney, Agent, or Firm* — Hayes Soloway PC

(57) **CLAIM**

The ornamental design for a display screen or portion thereof with animated graphical user interface, as shown and described.

**DESCRIPTION**

FIG. 1 is a front view of a display screen or portion thereof with animated graphical user interface;  
FIG. 2 is a front view of a second image thereof;  
FIG. 3 is a front view of a third image thereof;  
FIG. 4 is a front view of a fourth image thereof;  
FIG. 5 is a front view of a fifth image thereof;  
FIG. 6 is a front view of a sixth image thereof;  
FIG. 7 is a front view of a seventh image thereof;  
FIG. 8 is a front view of an eighth image thereof;  
FIG. 9 is a front view of a ninth image thereof;  
FIG. 10 is a front view of a tenth image thereof;  
FIG. 11 is a front view of an eleventh image thereof;  
FIG. 12 is a front view of a twelfth image thereof;  
FIG. 13 is a front view of a thirteenth image thereof;  
FIG. 14 is a front view of a fourteenth image thereof;  
FIG. 15 is a front view of a fifteenth image thereof;  
FIG. 16 is a front view of a sixteenth image thereof;  
FIG. 17 is a front view of a seventeenth image thereof;  
FIG. 18 is a front view of an eighteenth image thereof;  
FIG. 19 is a front view of a nineteenth image thereof;  
FIG. 20 is a front view of a twentieth image thereof; and,  
FIG. 21 is a front view of a twenty-first image thereof.  
The appearance of the image transitions sequentially between the images shown in FIGS. 1-21. The process or period in which an image transitions to another forms no part of the claimed design.  
The broken lines showing text, and a display screen or portion thereof form no part of the claimed design.

**1 Claim, 21 Drawing Sheets**

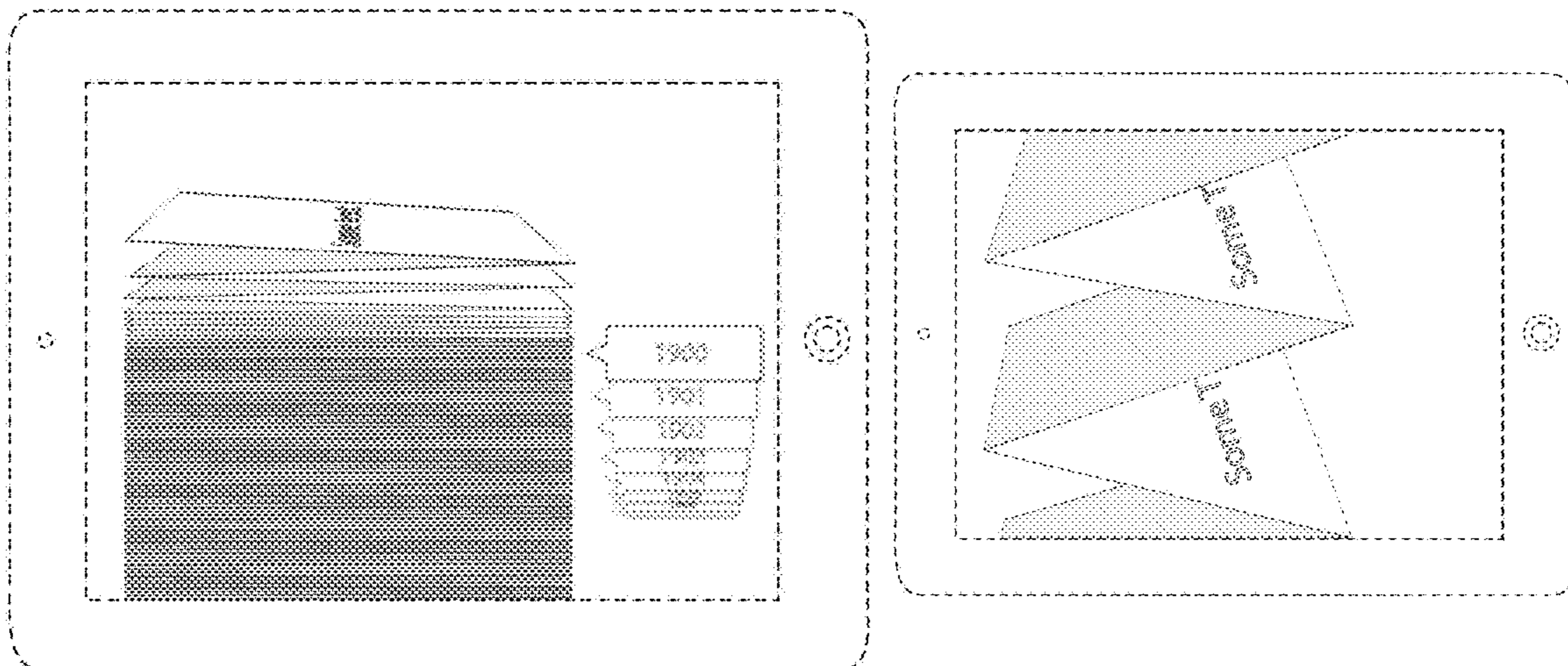

(58) **Field of Classification Search**

CPC ..... G06F 3/048-3/04897; B42D 15/04; B42D  
15/042; B64H 45/04

See application file for complete search history.

(56) **References Cited**

U.S. PATENT DOCUMENTS

5,622,384 A \* 4/1997 Bradley ..... B42D 15/042  
281/2  
5,630,511 A \* 5/1997 Bose ..... B65D 83/0805  
206/215  
5,690,250 A \* 11/1997 Gooding, Jr. .... A47G 11/001  
206/494  
5,815,964 A \* 10/1998 Douglas ..... B42D 15/042  
283/117  
6,015,374 A \* 1/2000 Murphy ..... B31D 5/0047  
493/352  
D631,269 S \* 1/2011 Davenport ..... D6/518  
D746,908 S \* 1/2016 Hart ..... D19/1  
D747,409 S \* 1/2016 Hart ..... D19/1  
2010/0038265 A1\* 2/2010 Geoffroy ..... B65H 18/28  
206/223  
2015/0050452 A1\* 2/2015 Penfield ..... B65H 45/24  
428/124

\* cited by examiner

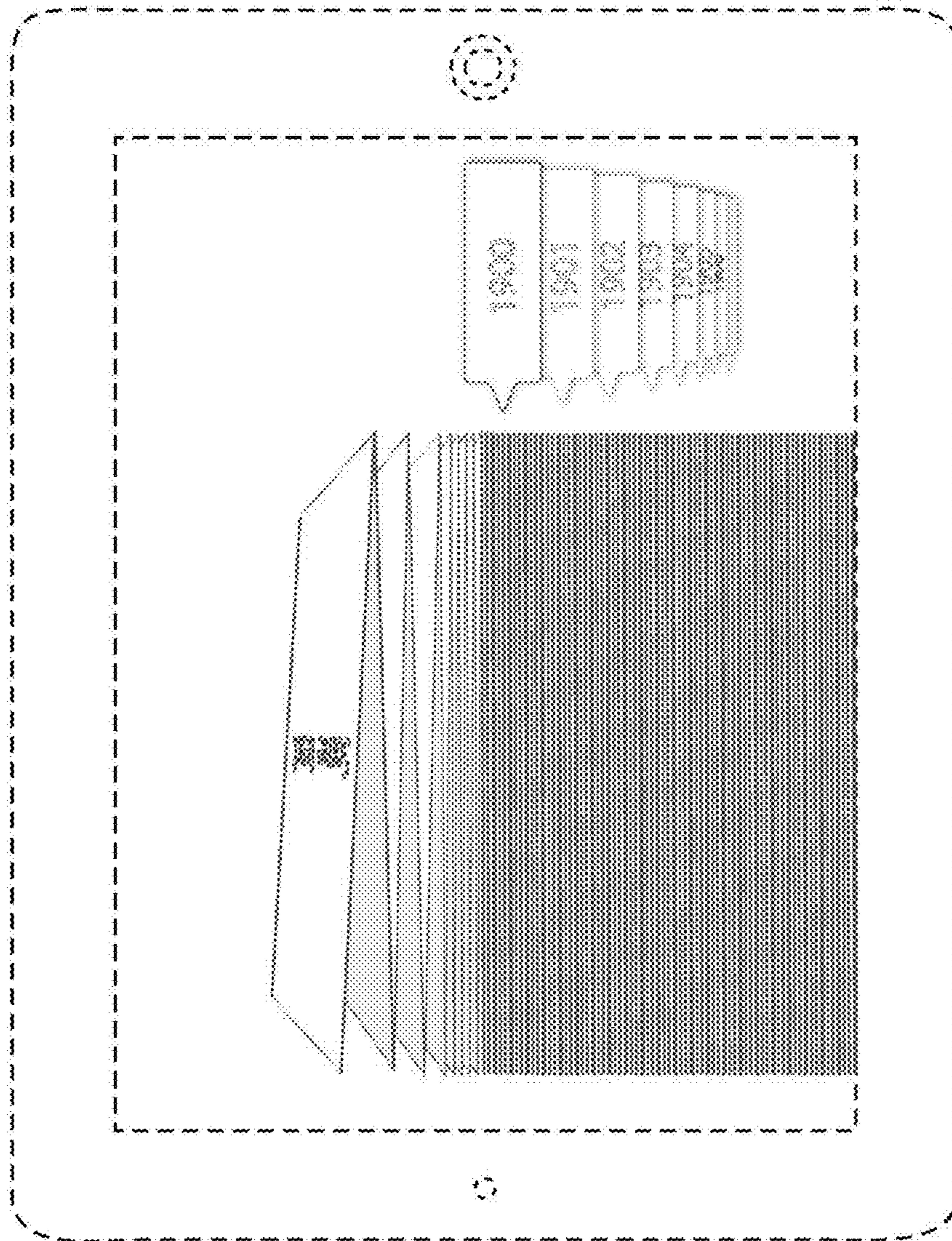

**Fig. 1**

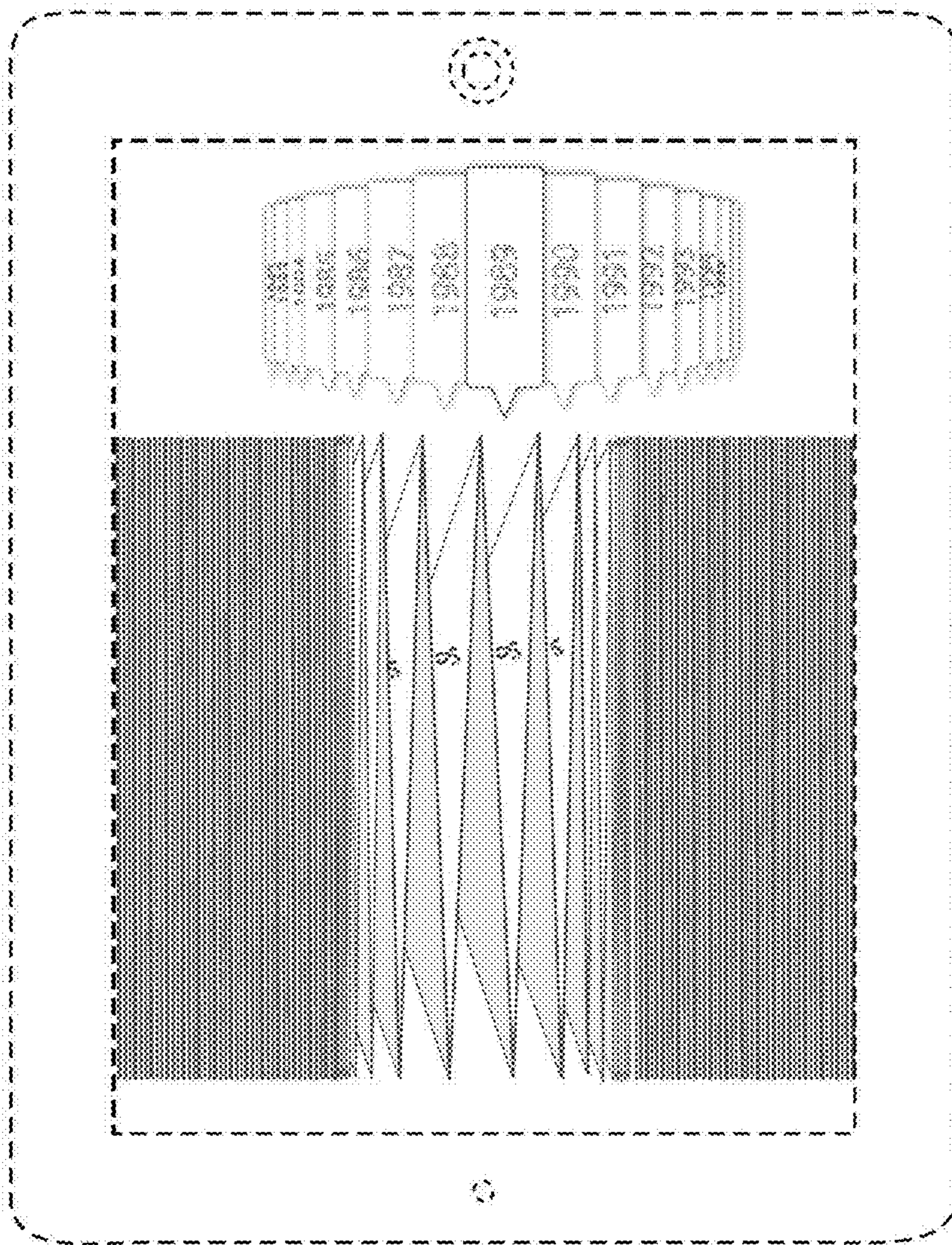

Fig. 2

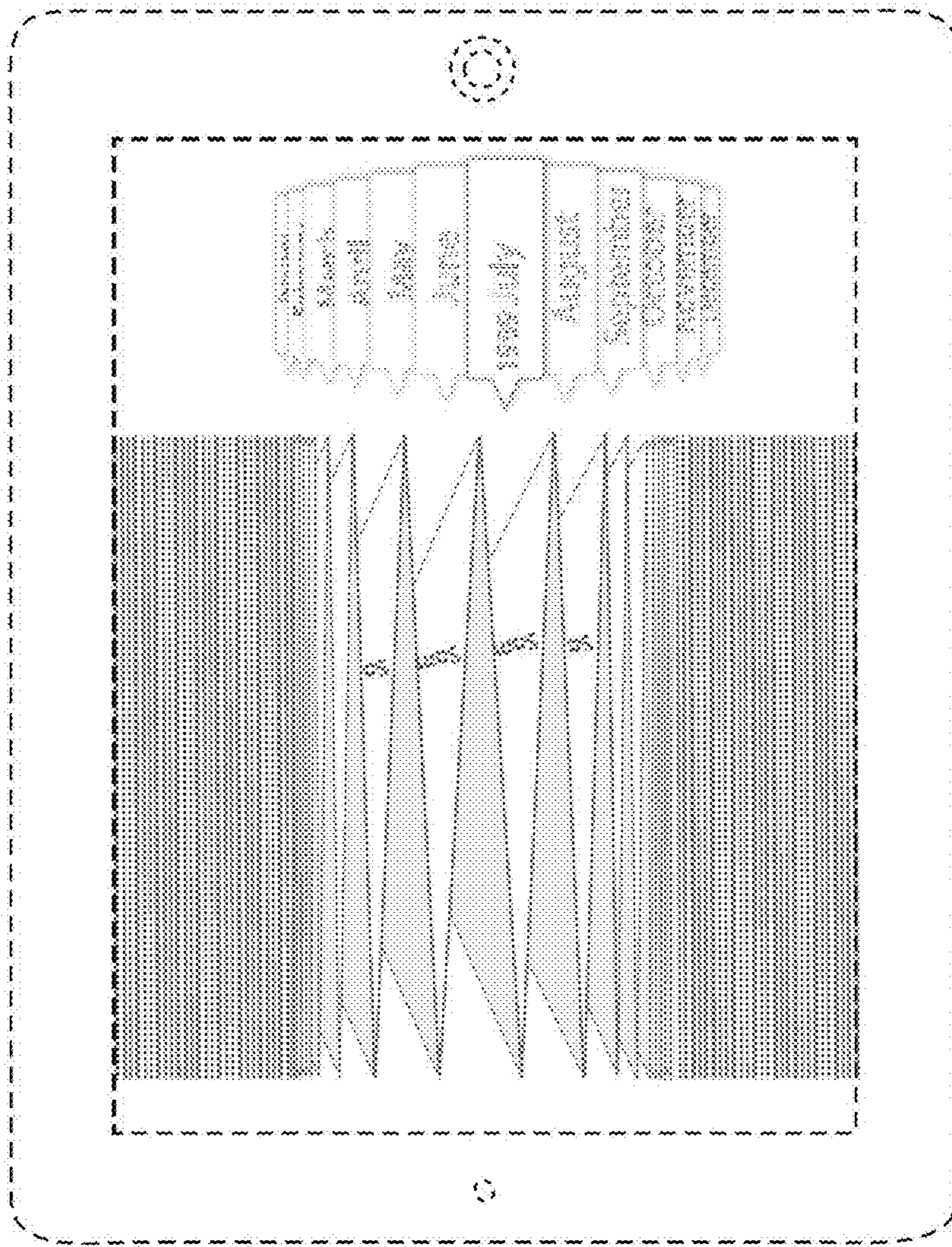

Fig. 3

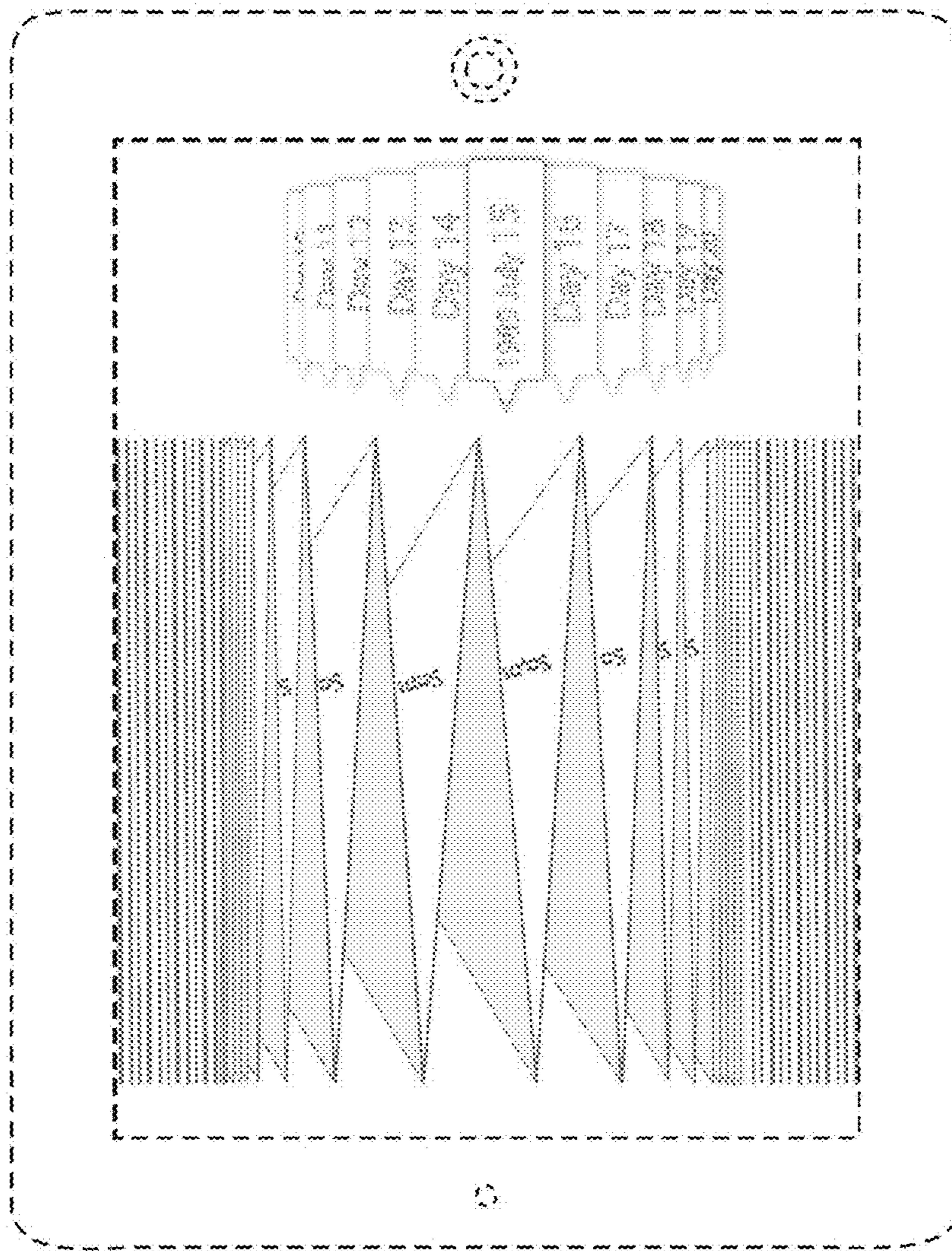

Fig. 4

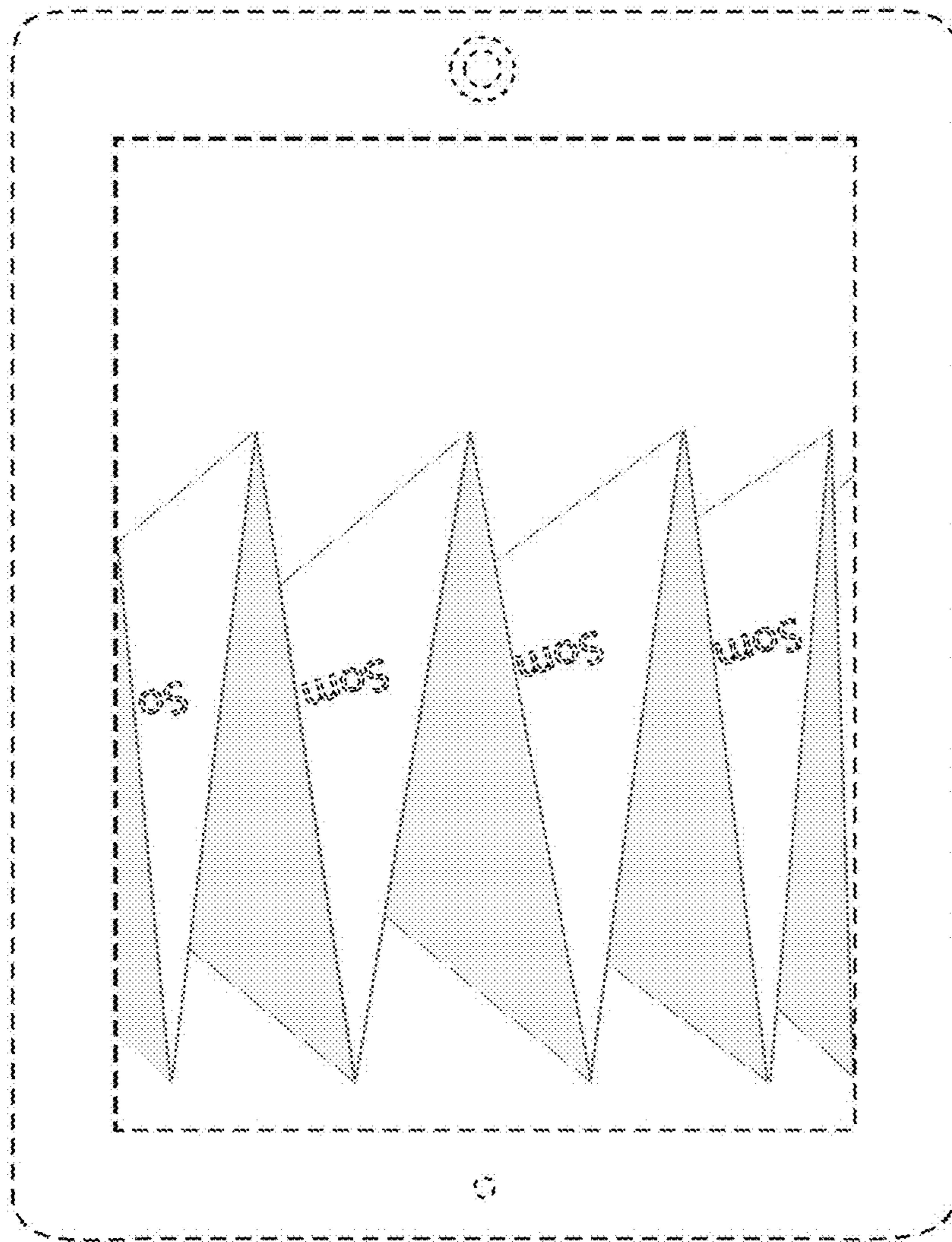

Fig. 5

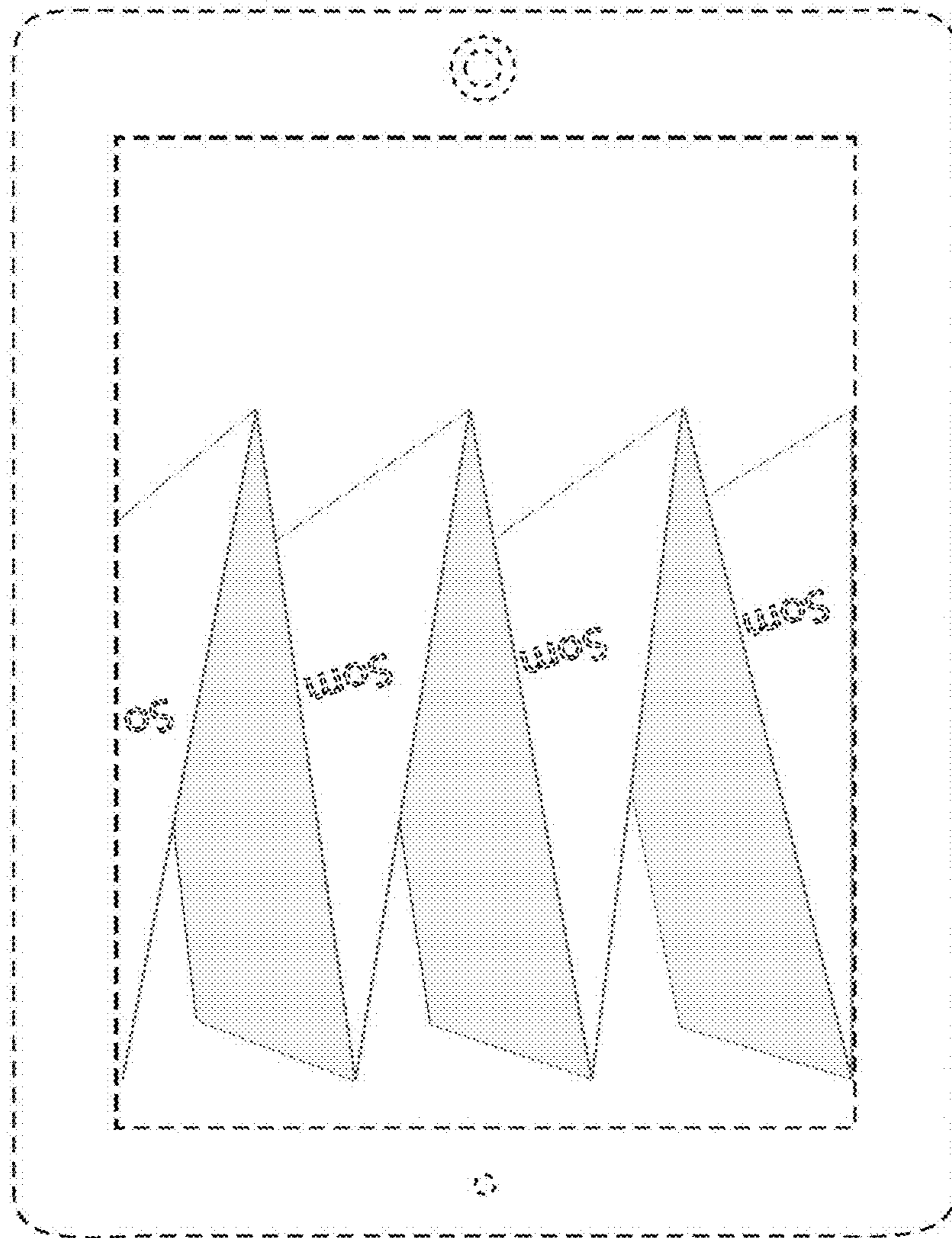

Fig. 6



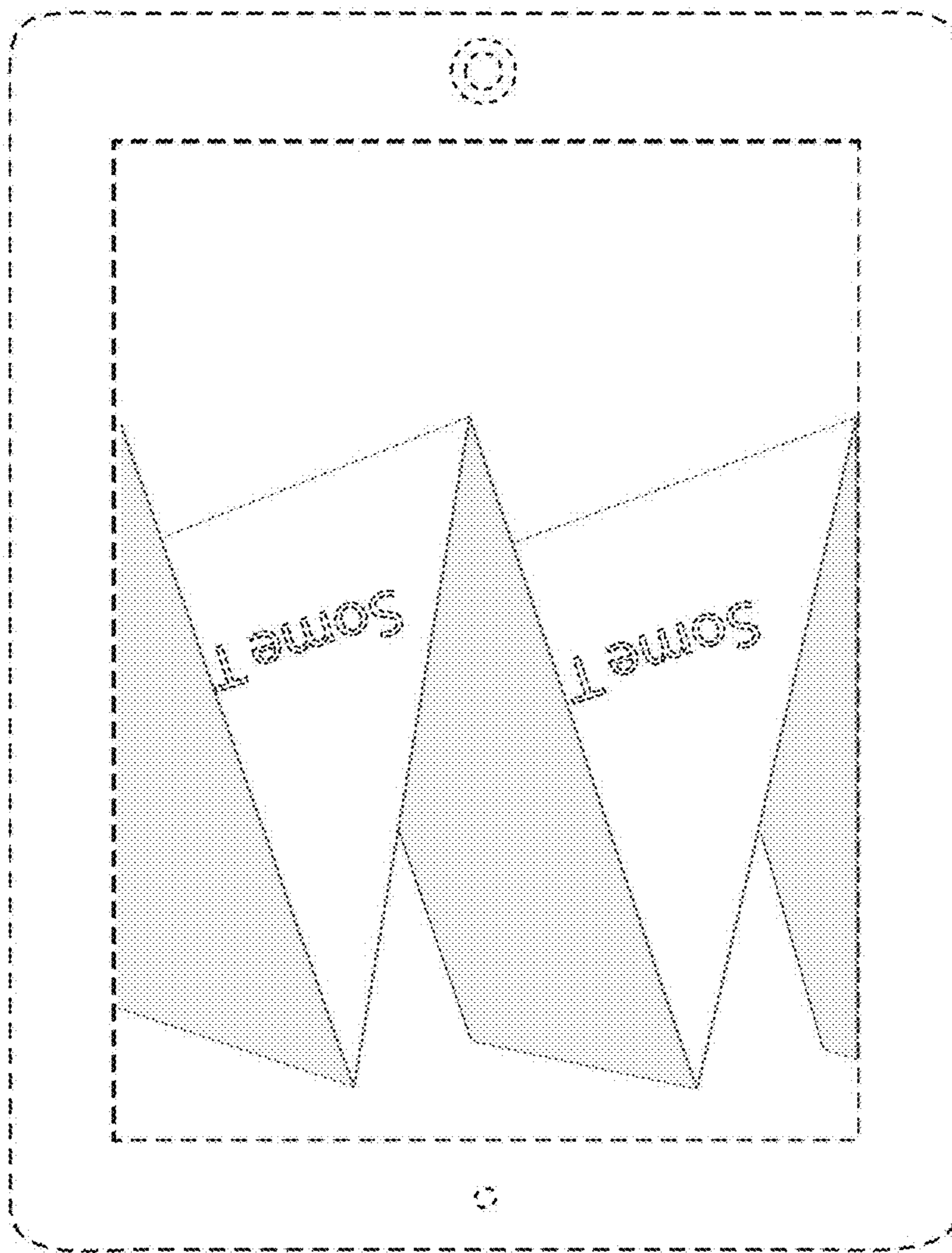

Fig. 7

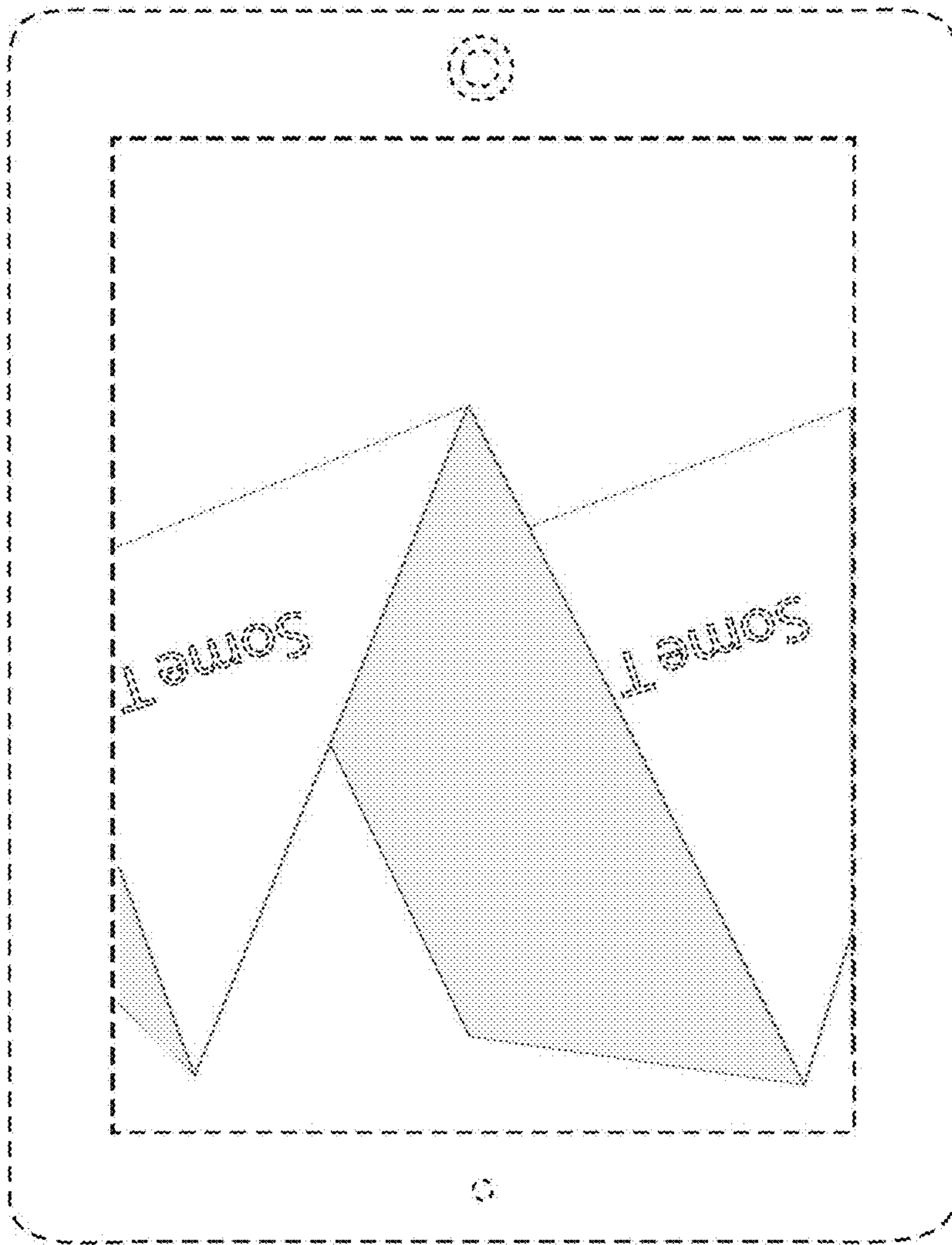

Fig. 8

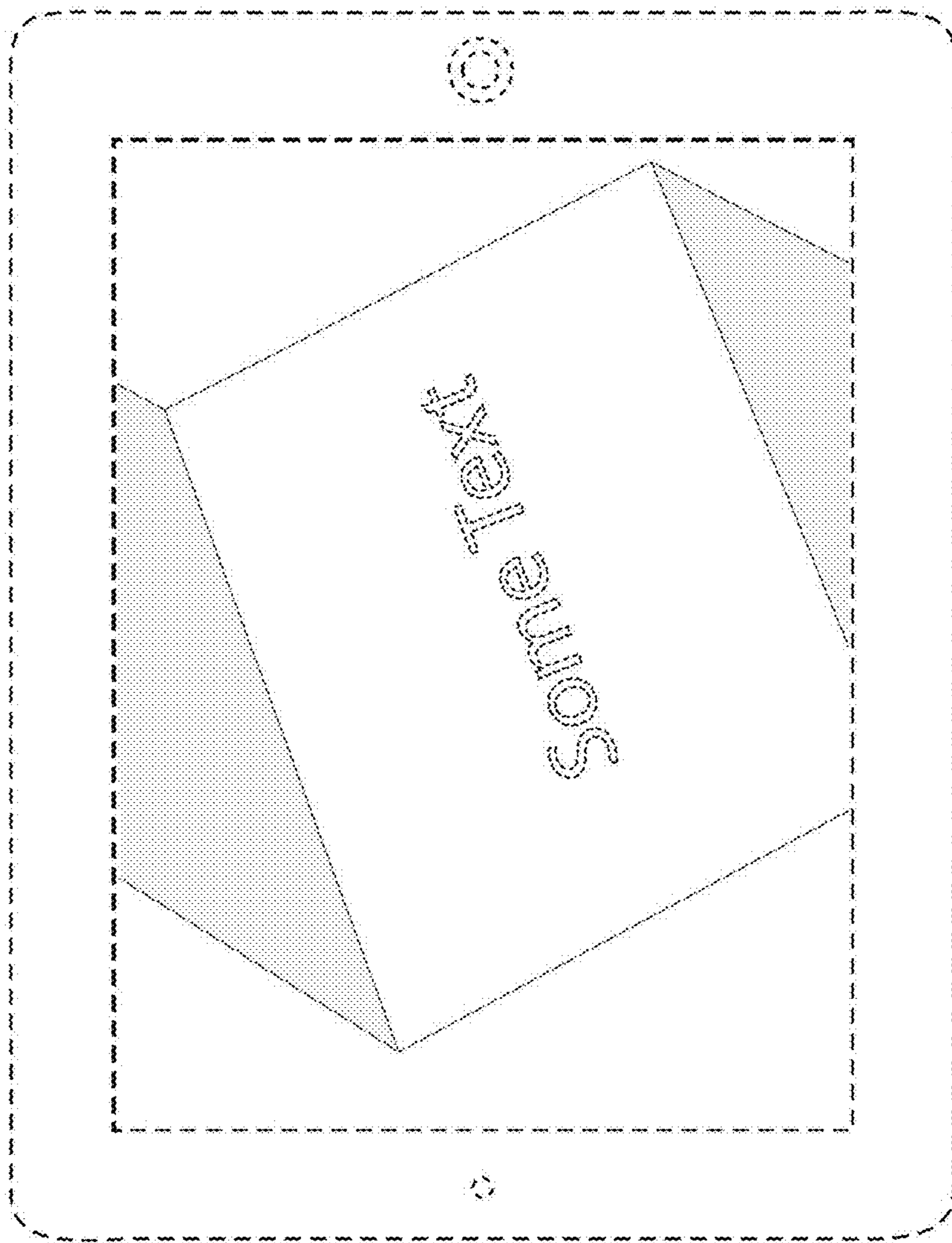
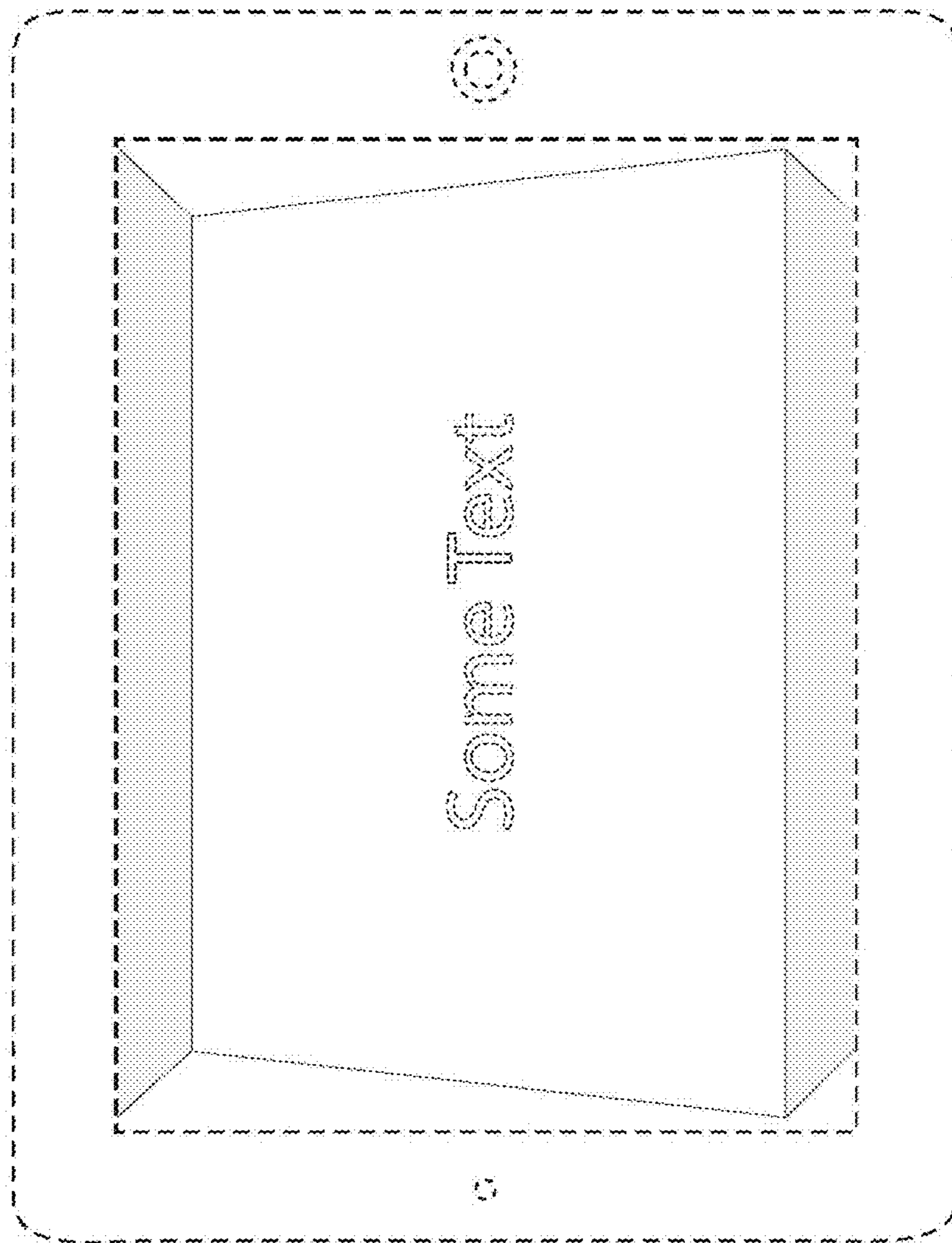
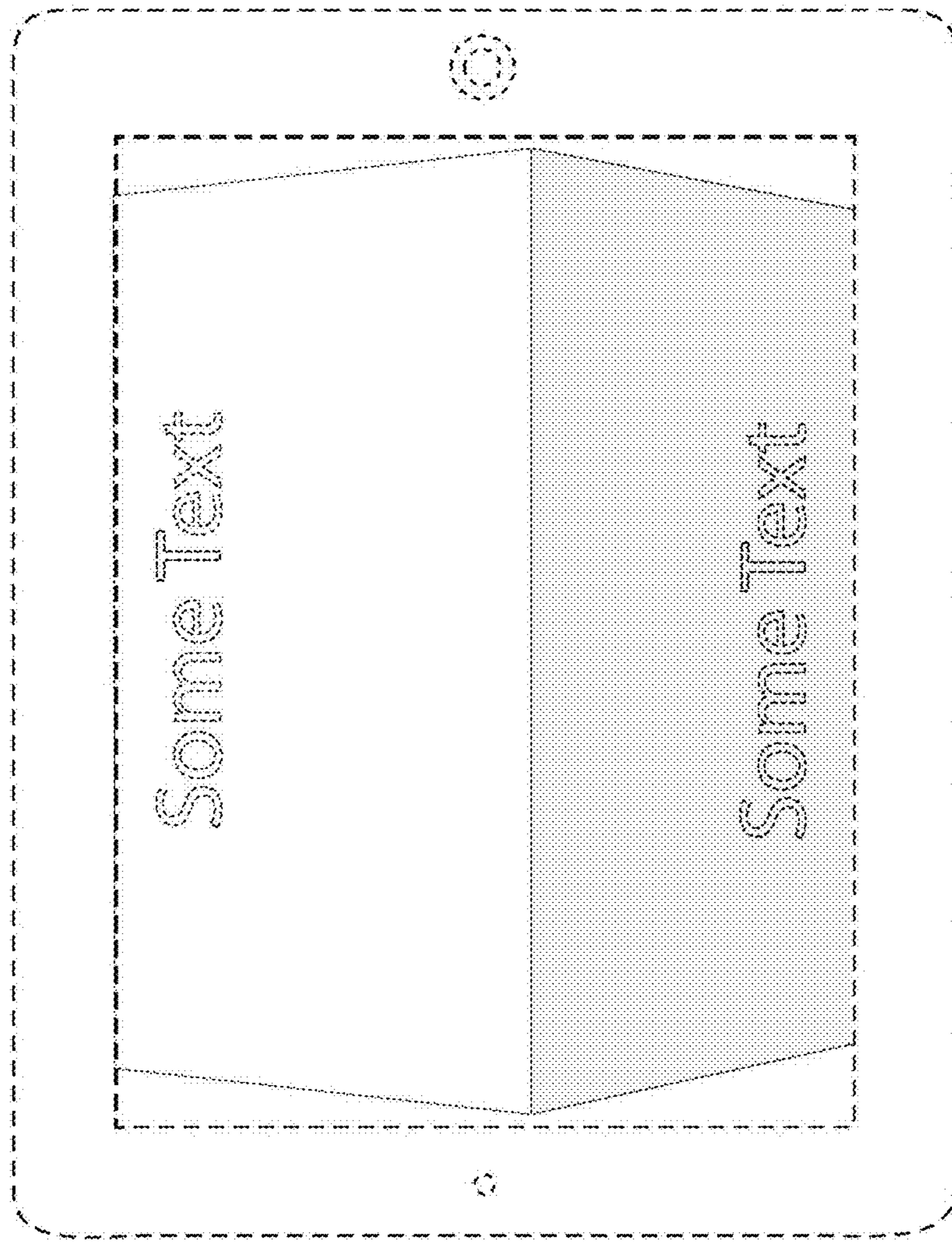

Fig. 9



**Fig. 10**



**Fig. 11**

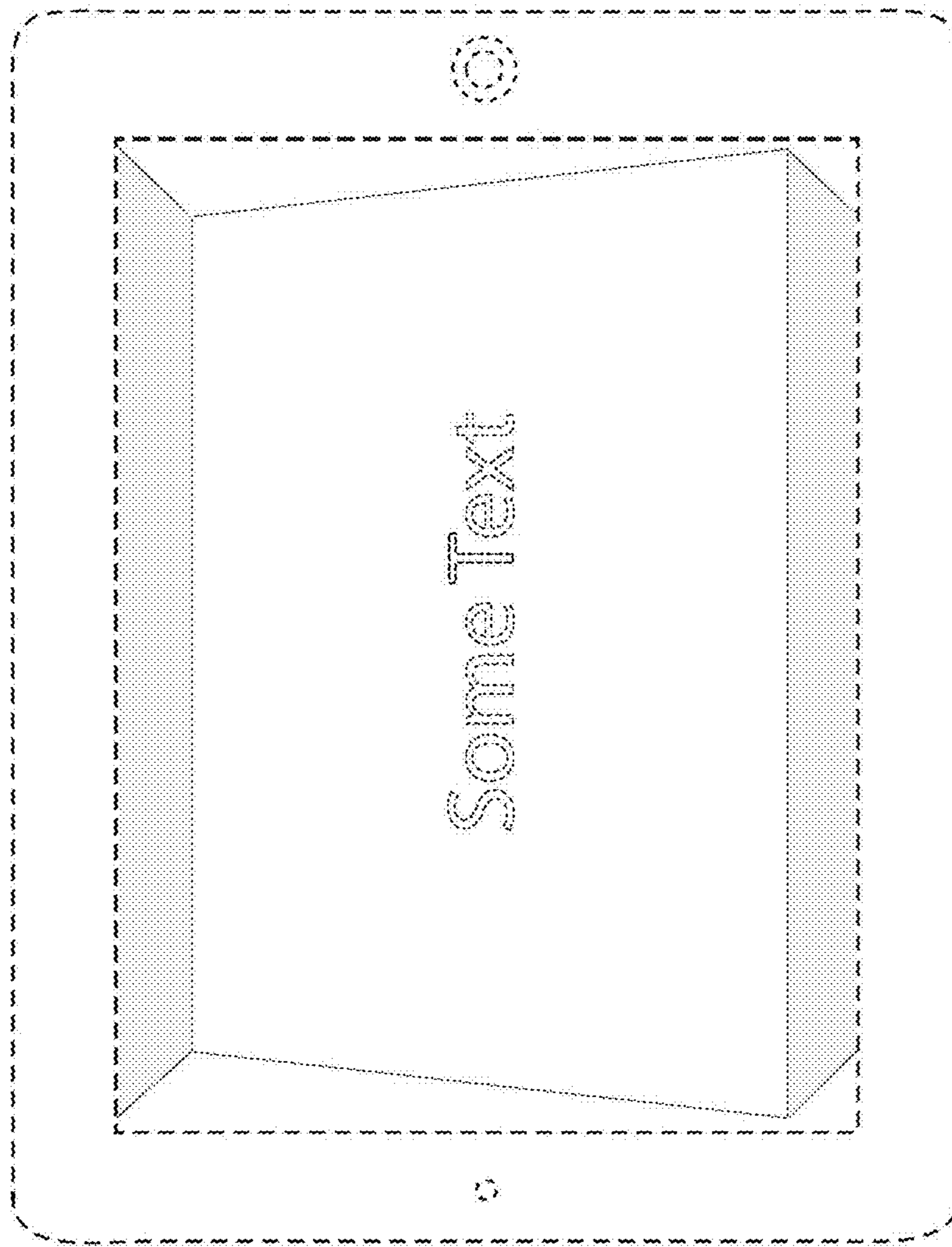

**Fig. 12**

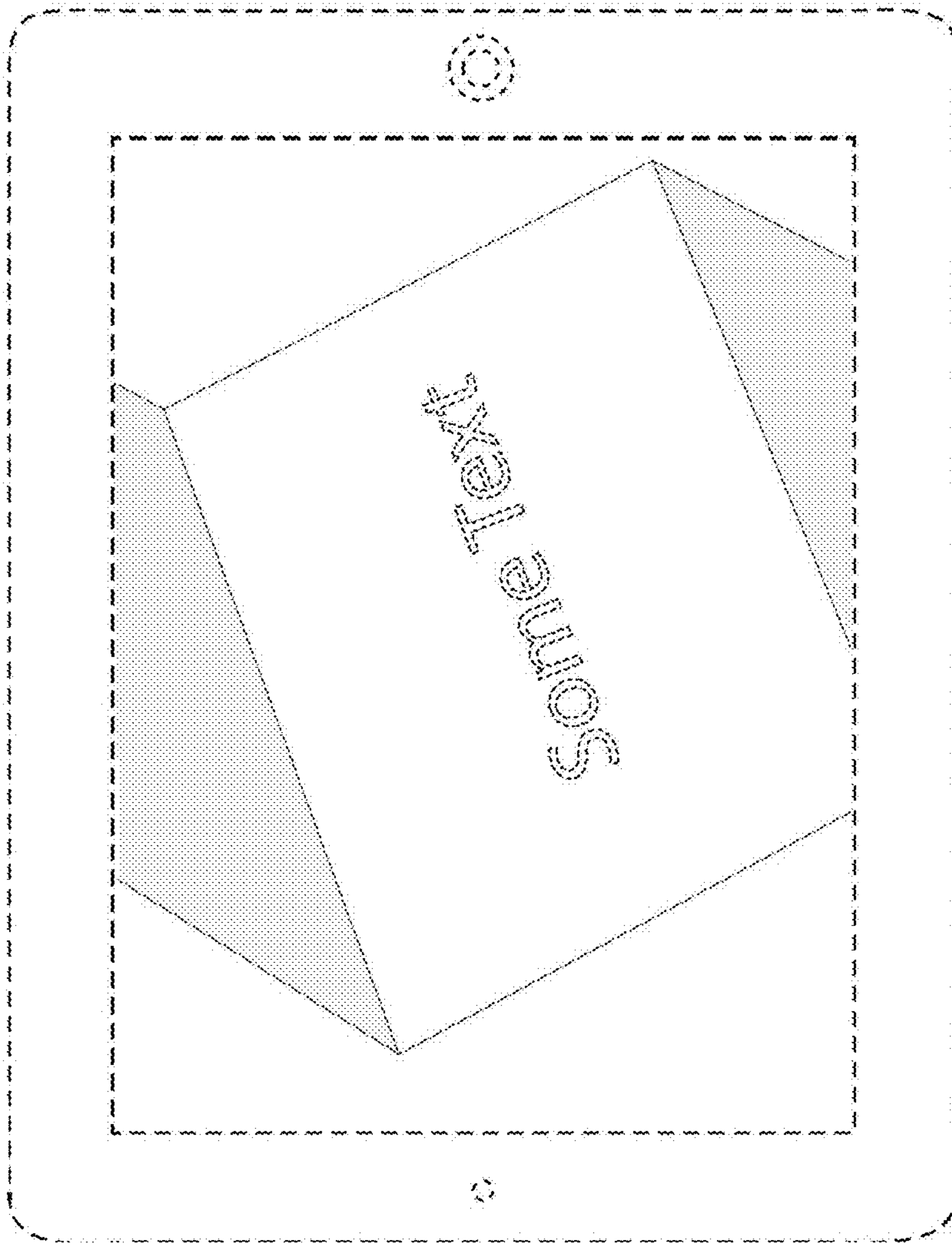

**Fig. 13**

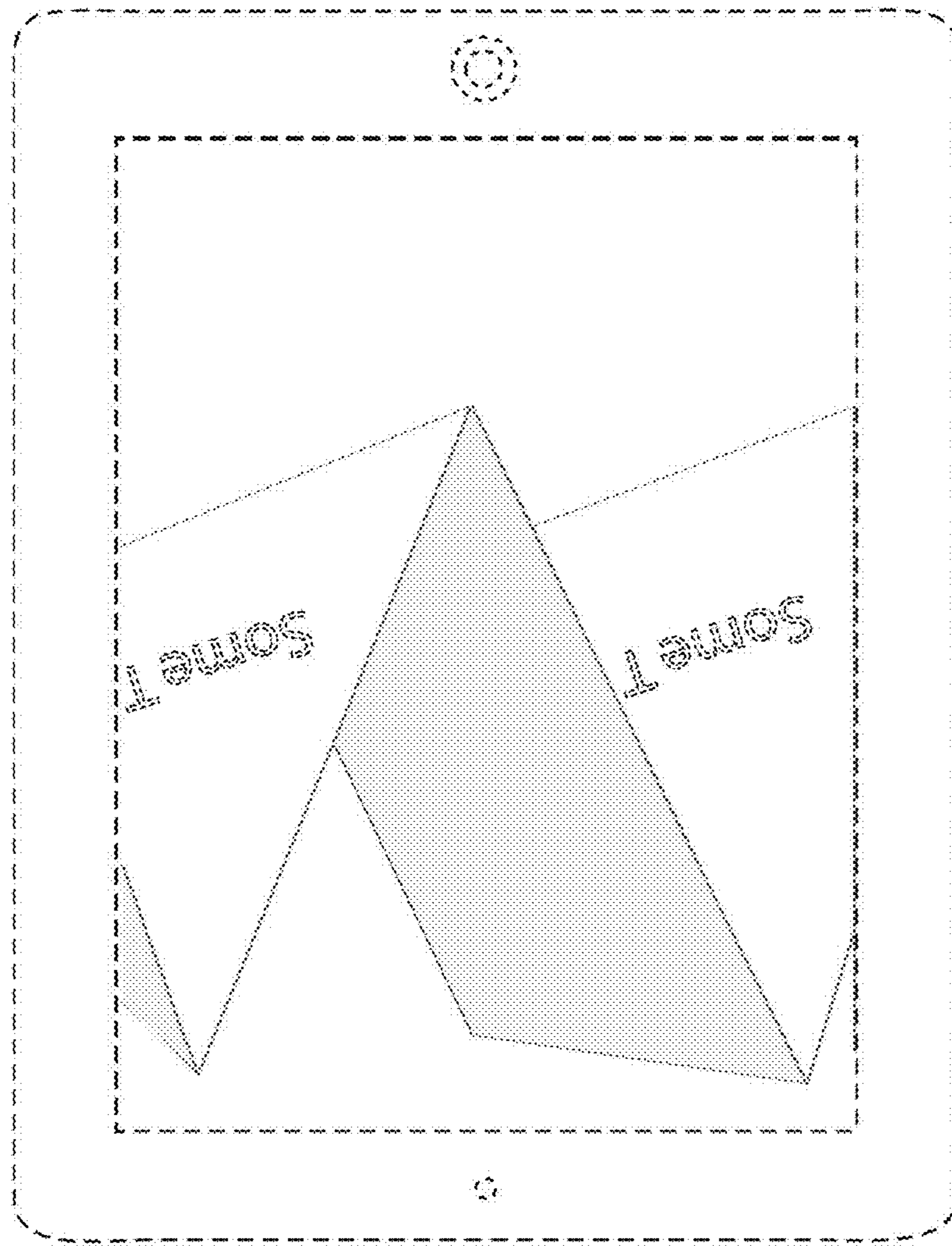

Fig. 14



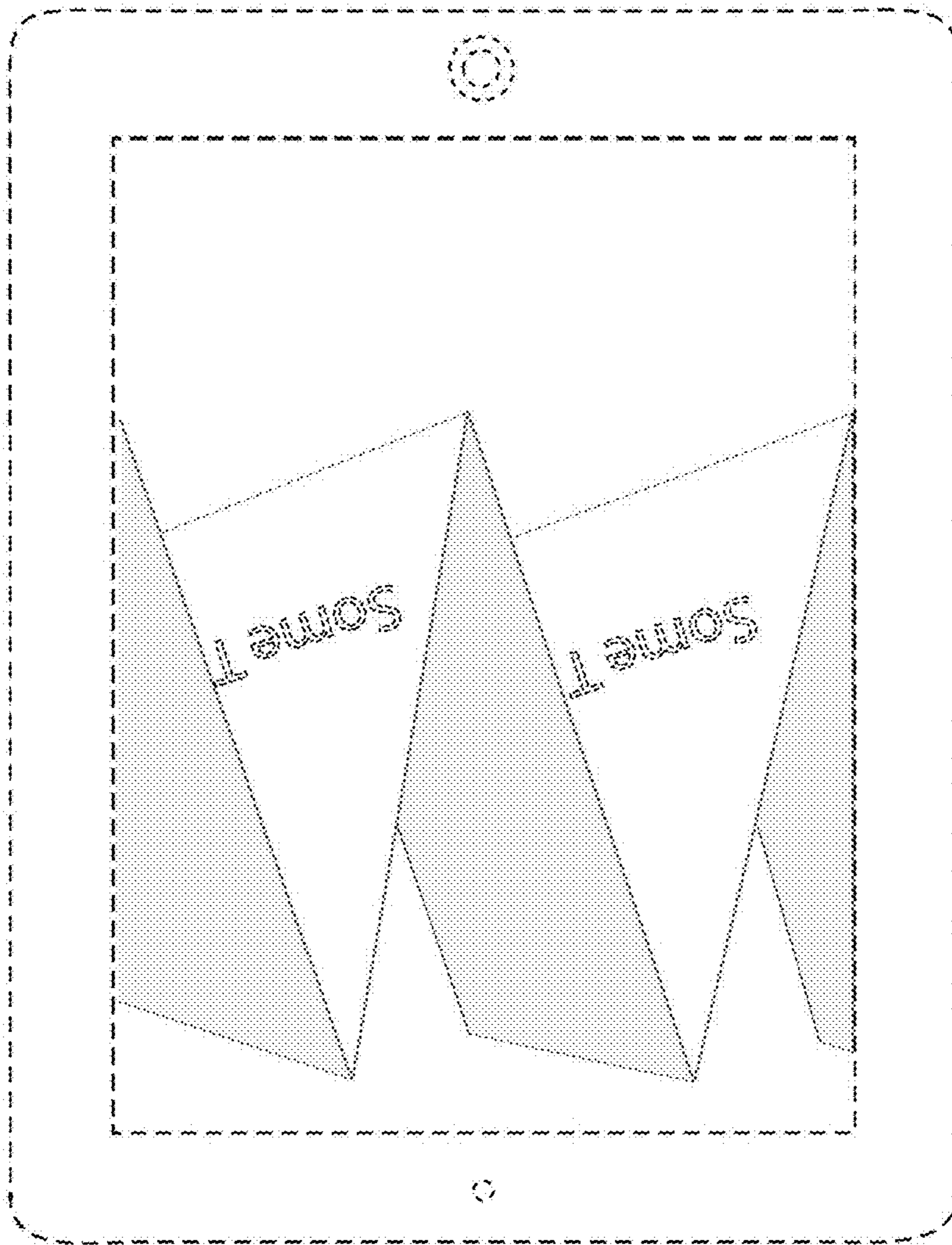

Fig. 15

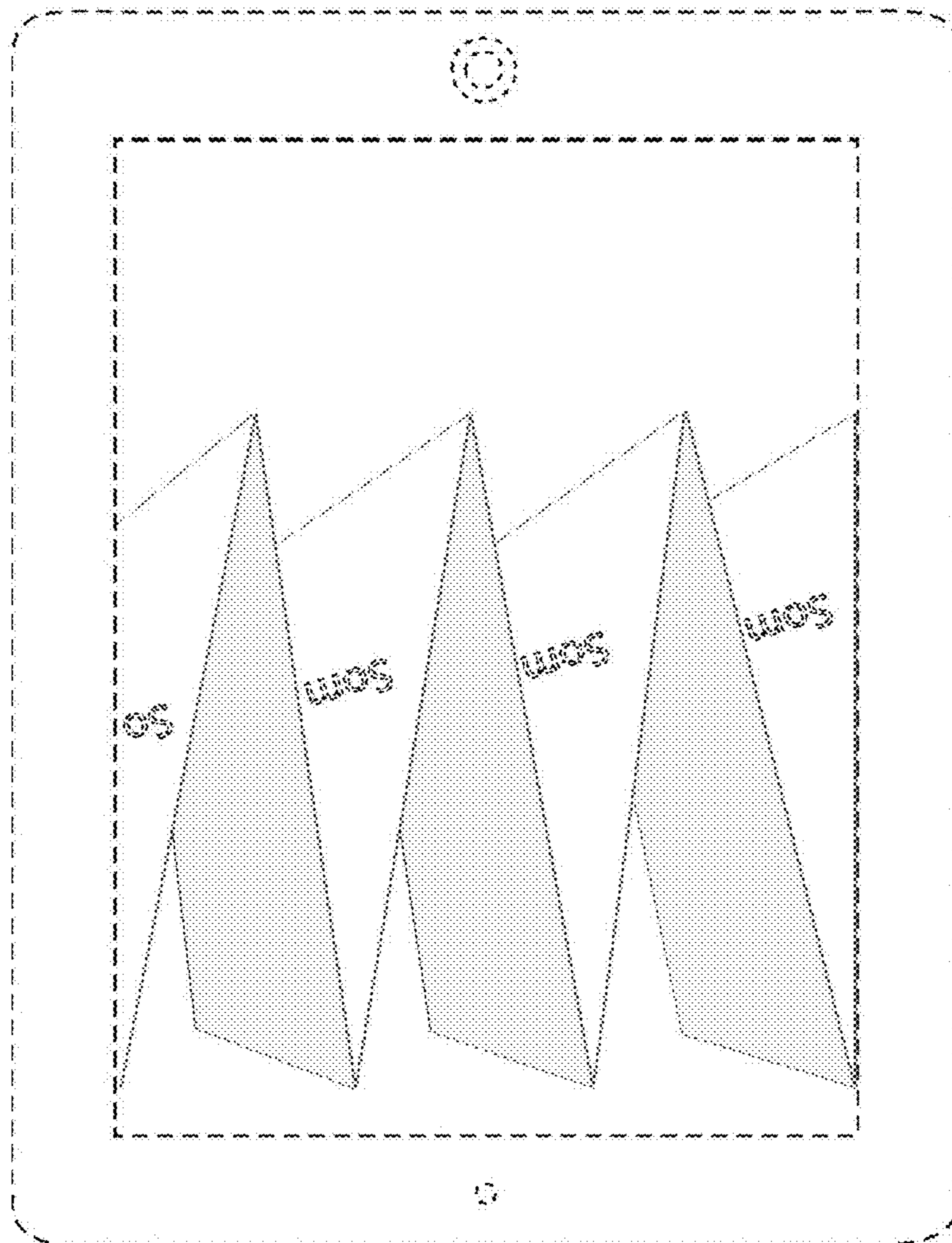

Fig. 16

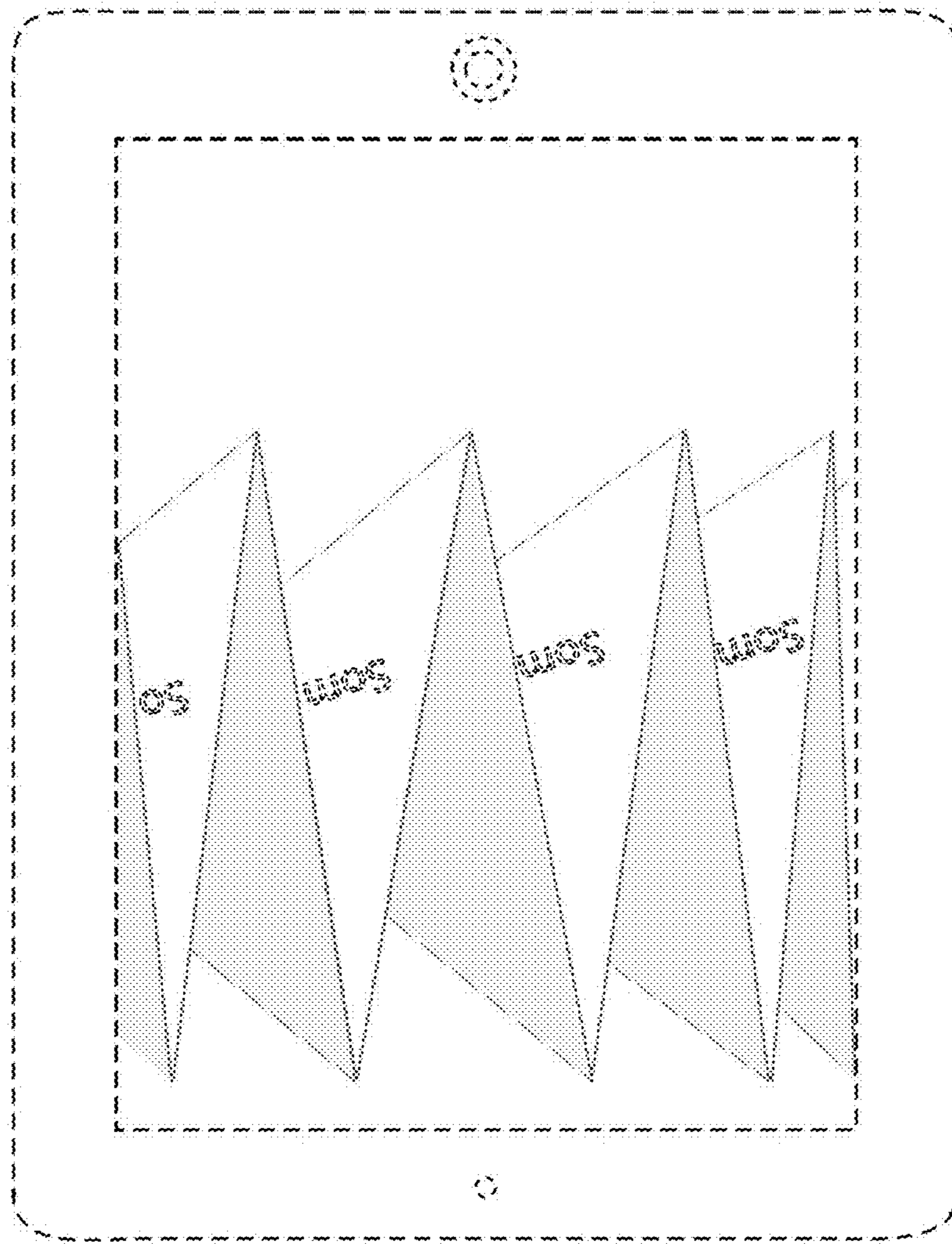

Fig. 17



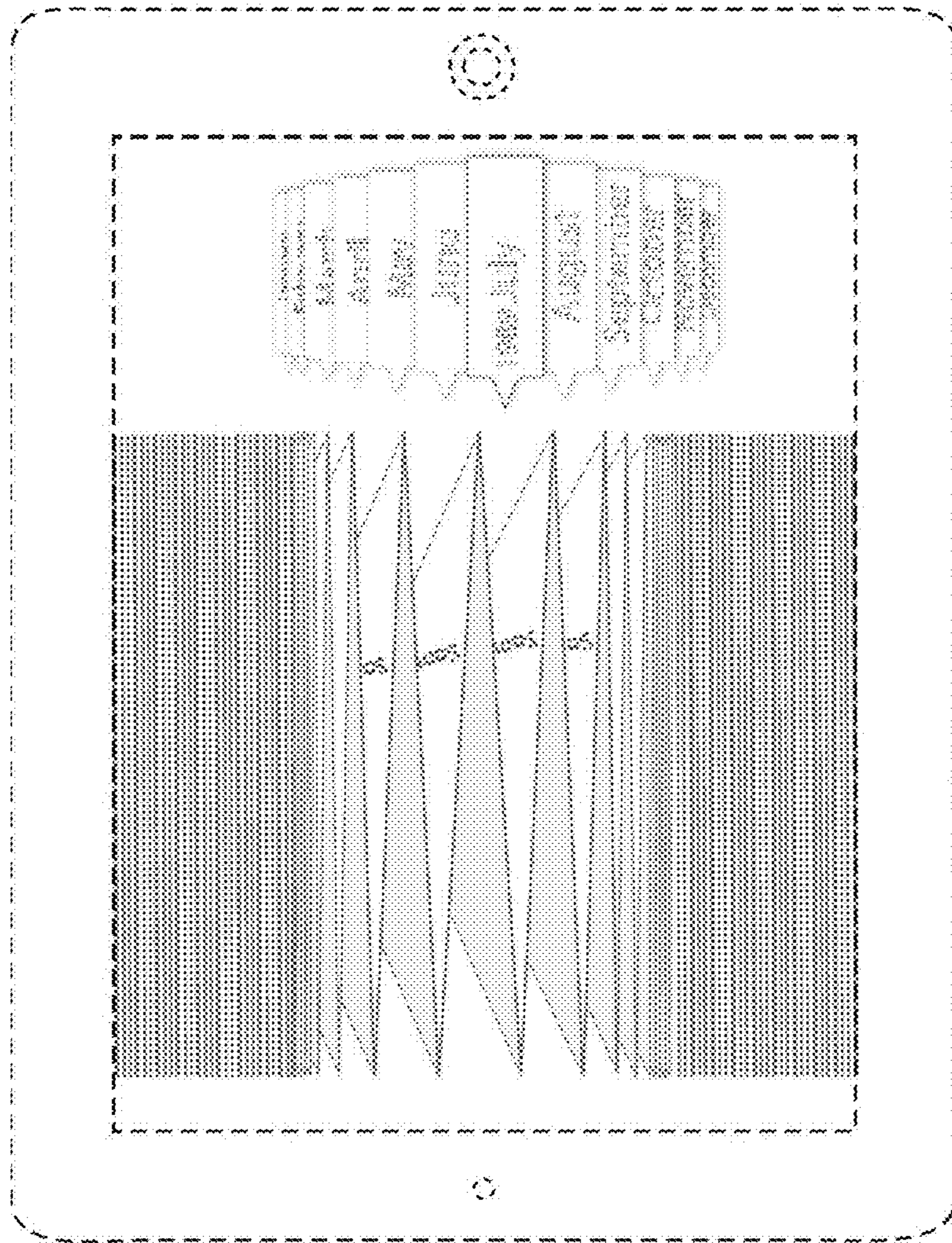

Fig. 19

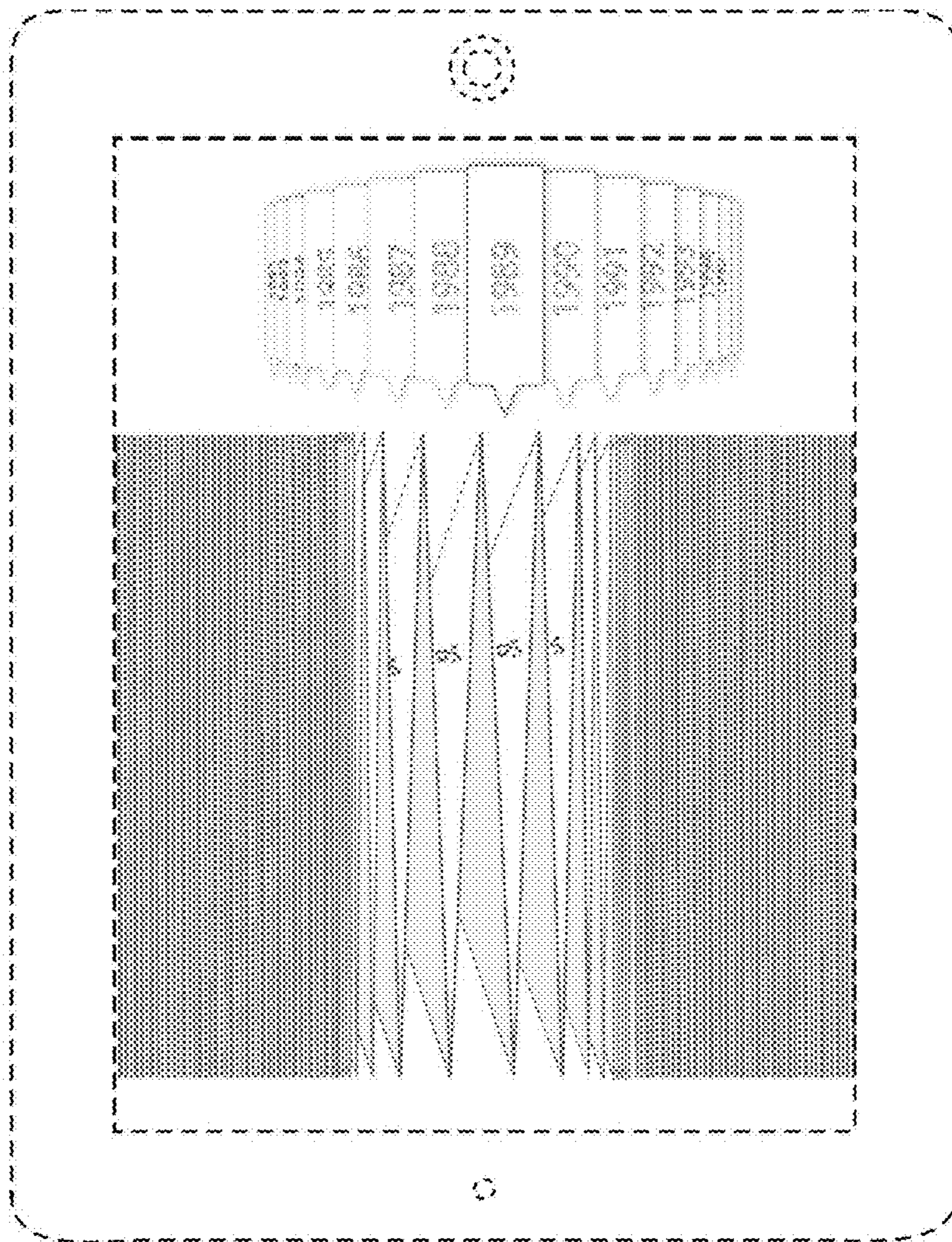

Fig. 20

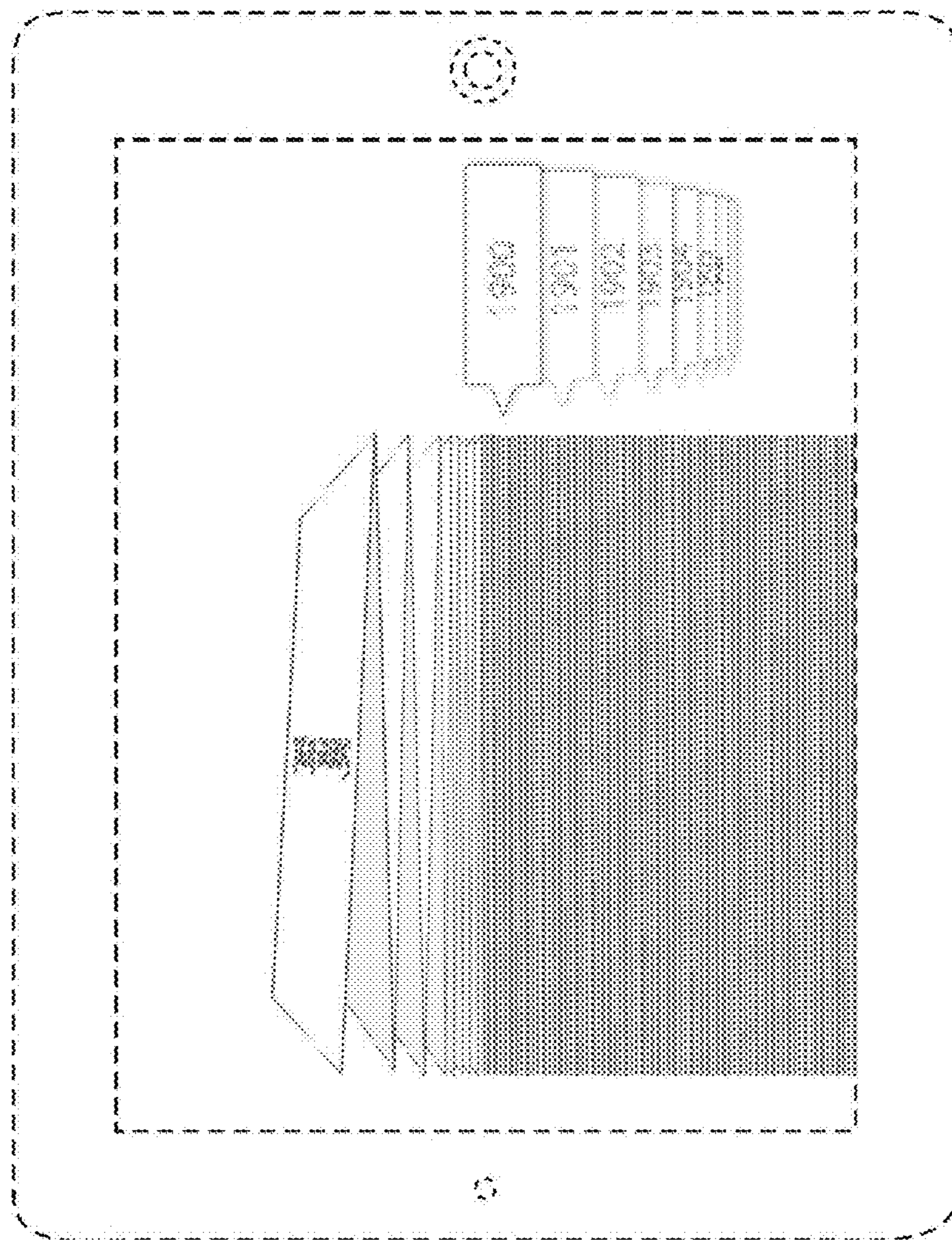

Fig. 21