



US00D785563S

(12) **United States Design Patent**
Yang

(10) **Patent No.:** **US D785,563 S**

(45) **Date of Patent:** **** May 2, 2017**

(54) **EMERGENCY POWER SUPPLY (PQ-500)**

(71) Applicant: **Ningbo Gude Electronic Technology Co., Ltd**, Zhejiang Province (CN)

(72) Inventor: **Zhaolin Yang**, Zhejiang Province (CN)

(**) Term: **15 Years**

(21) Appl. No.: **29/562,806**

(22) Filed: **Apr. 29, 2016**

(51) **LOC (10) Cl.** **13-02**

(52) **U.S. Cl.**
USPC **D13/103**

(58) **Field of Classification Search**
USPC D13/110, 103, 108, 107, 119, 184;
D14/480.1-480.7, 356; D8/373; 320/112
CPC Y02E 60/12; H01R 18/6675; H01R 13/60;
H01R 13/72; H01M 2/1055; B65H 75/02;
B65H 75/24

See application file for complete search history.

(56) **References Cited**

U.S. PATENT DOCUMENTS

D562,235 S *	2/2008	Hussaini	D13/110
D601,088 S *	9/2009	Scheucher	D13/103
D681,550 S *	5/2013	Corbin	D13/103
D696,188 S *	12/2013	Loeck	D13/108
D701,490 S *	3/2014	Inskeep	D13/110

D705,162 S *	5/2014	Mueller	D13/110
D727,846 S *	4/2015	Wen	D13/110
D742,822 S *	11/2015	Ju	D13/103
D753,059 S *	4/2016	Krantz	D13/110
D760,164 S *	6/2016	Aida	D13/110
D775,070 S *	12/2016	Lei	D13/107

* cited by examiner

Primary Examiner — Daniel Bui

Assistant Examiner — Andrew Kerr

(74) *Attorney, Agent, or Firm* — Prakash Nama; Global IP Services, PLLC

(57) **CLAIM**

The ornamental design for an emergency power supply (PQ-500), as shown and described.

DESCRIPTION

FIG. 1 is a front elevational view of an emergency power supply (PQ-500) showing my new design; FIG. 2 is a rear elevational view thereof; FIG. 3 is a left side elevational view thereof; FIG. 4 is a right side elevational view thereof; FIG. 5 is a top plan view thereof; FIG. 6 is a bottom plan view thereof; FIG. 7 is a perspective view thereof; and, FIG. 8 is a second perspective view thereof.

1 Claim, 3 Drawing Sheets

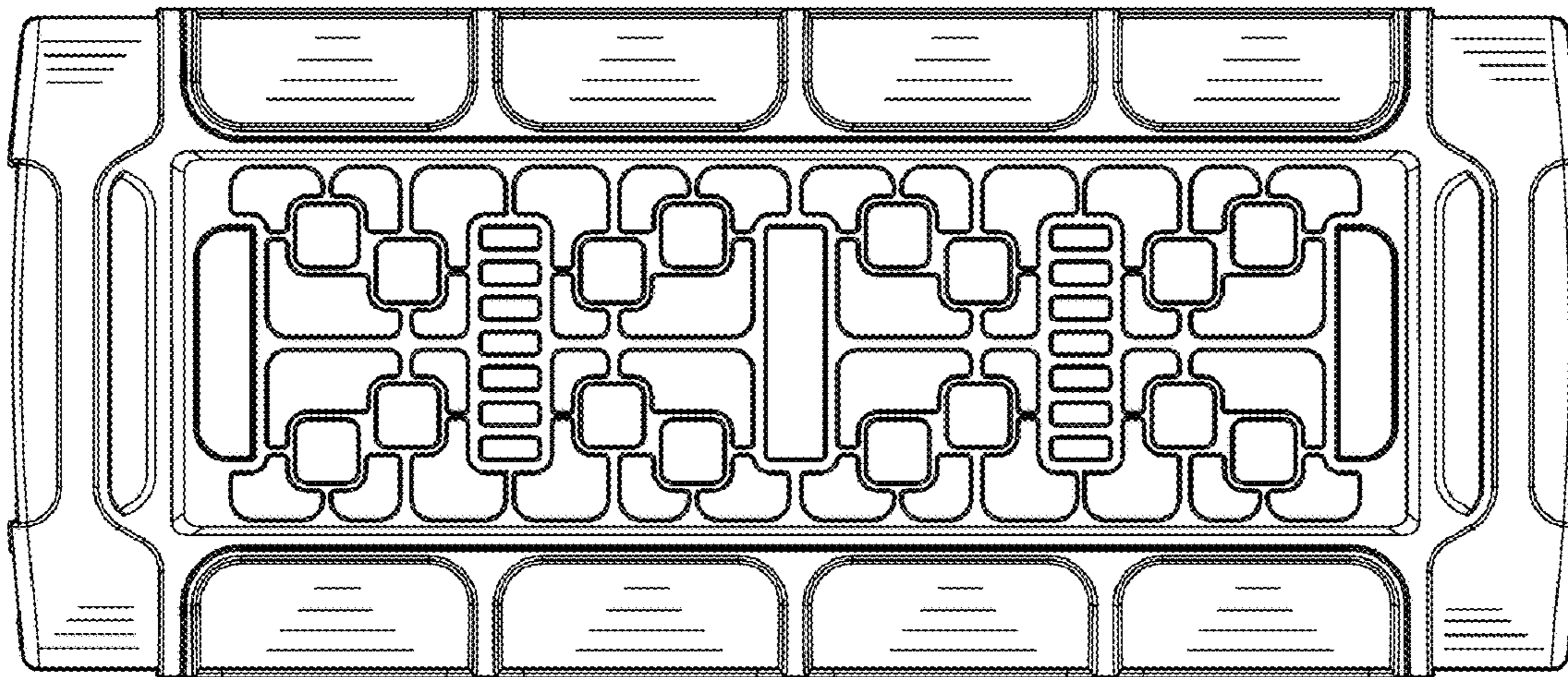

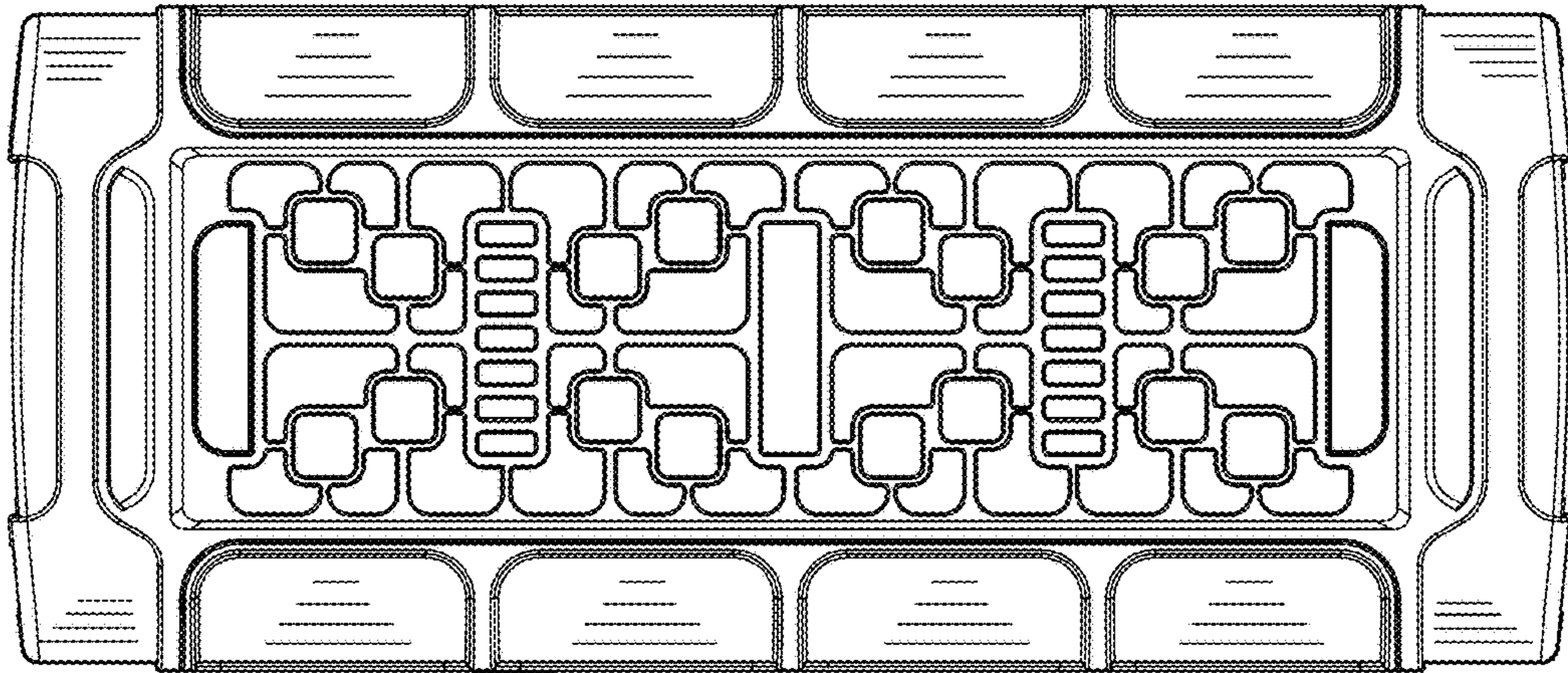

FIG. 1

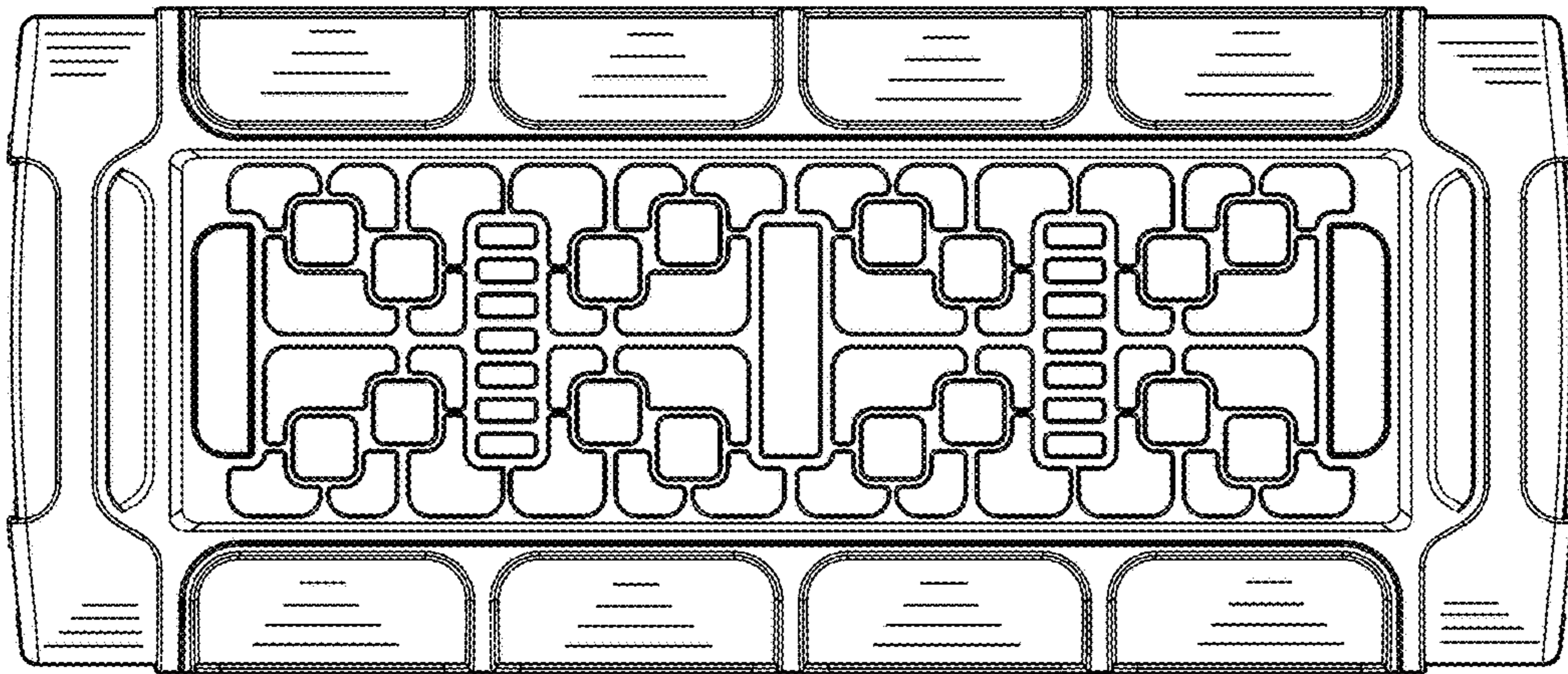

FIG. 2

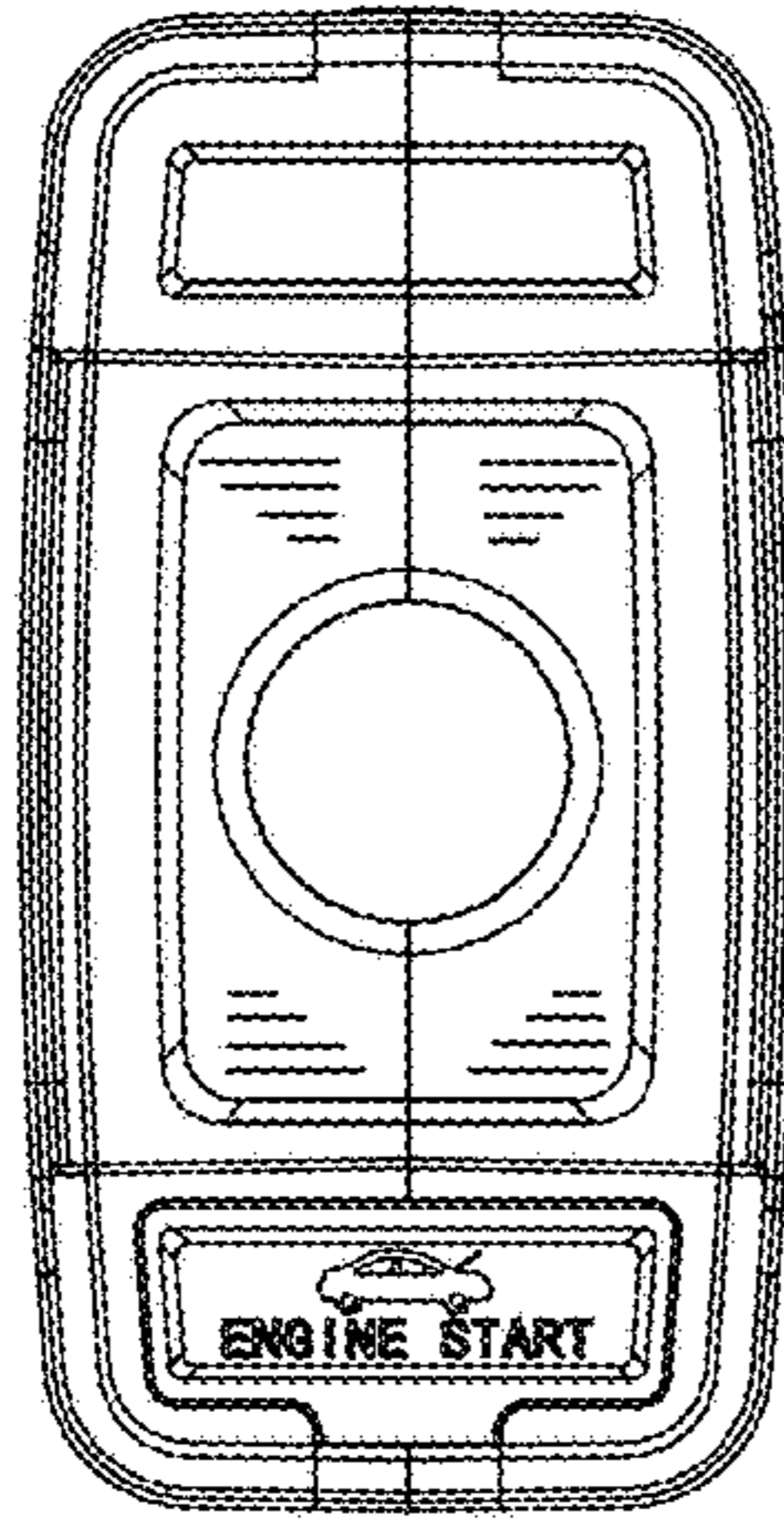

FIG. 3

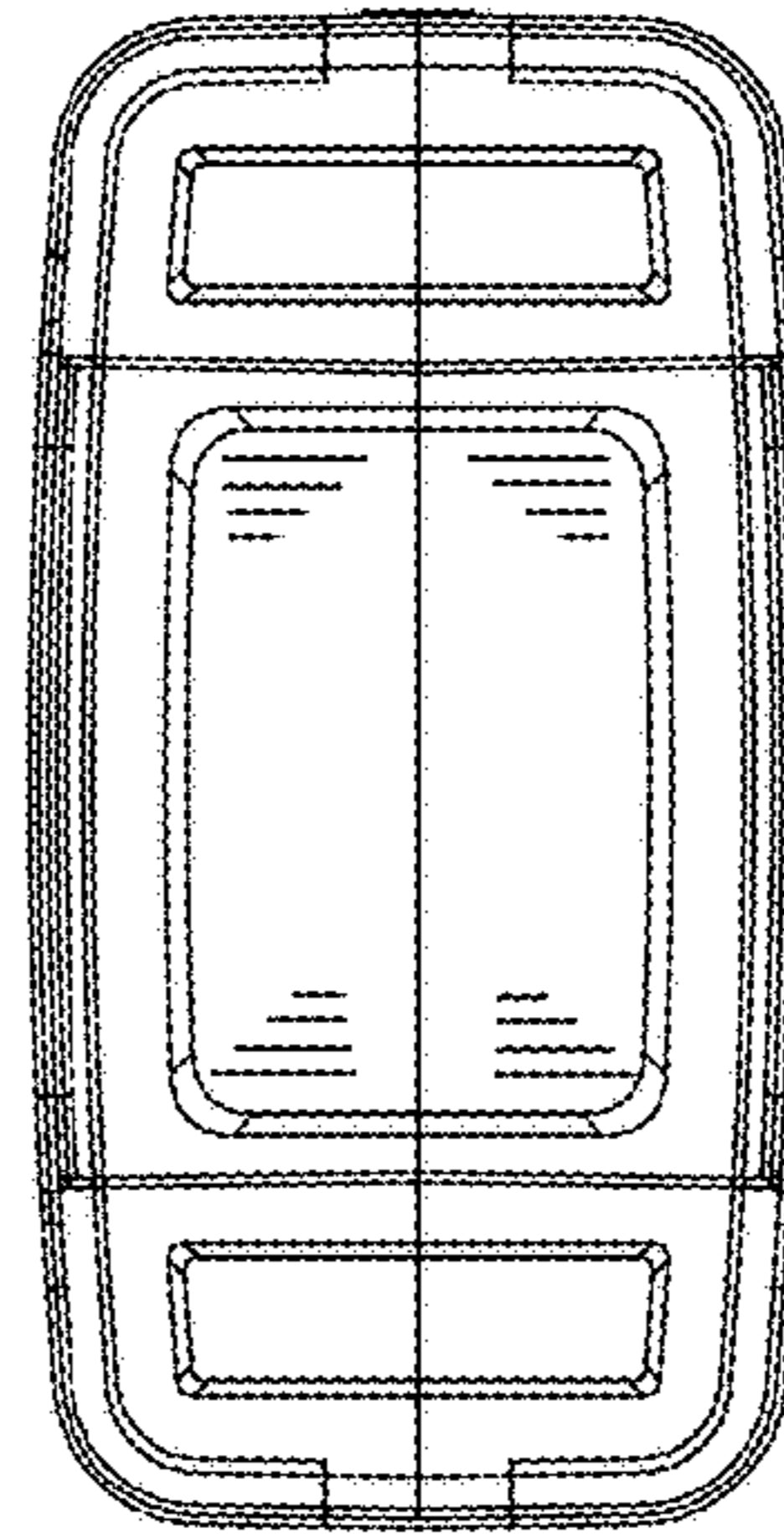

FIG. 4

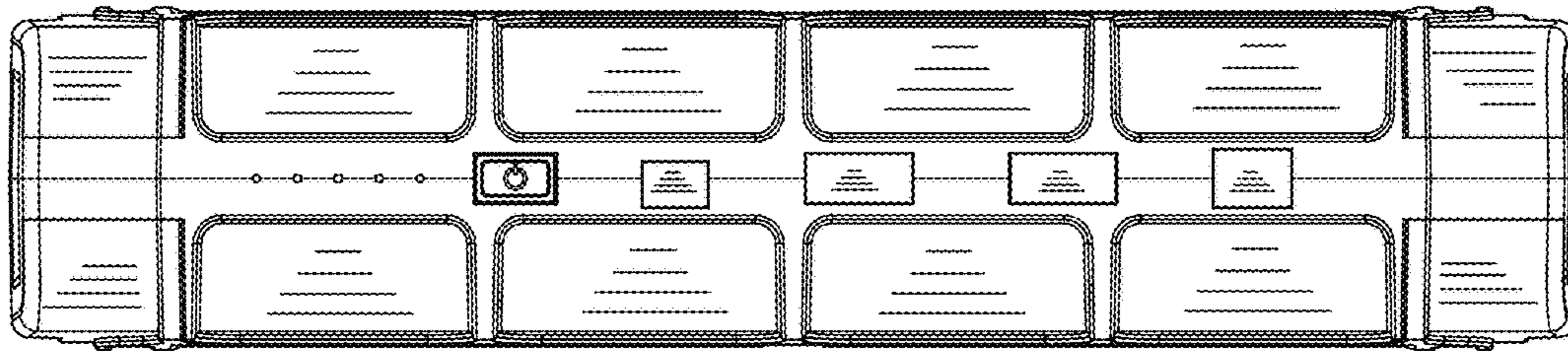

FIG. 5

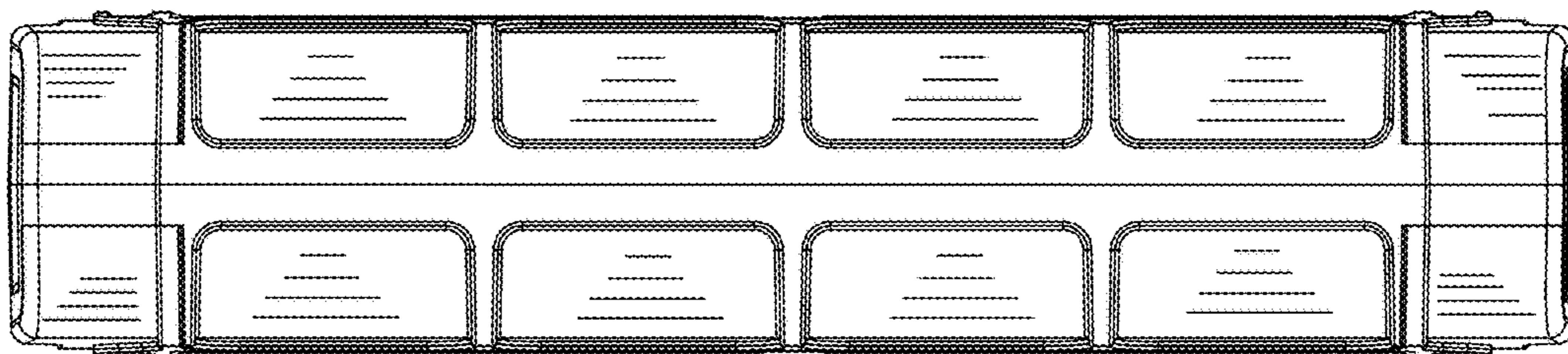

FIG. 6

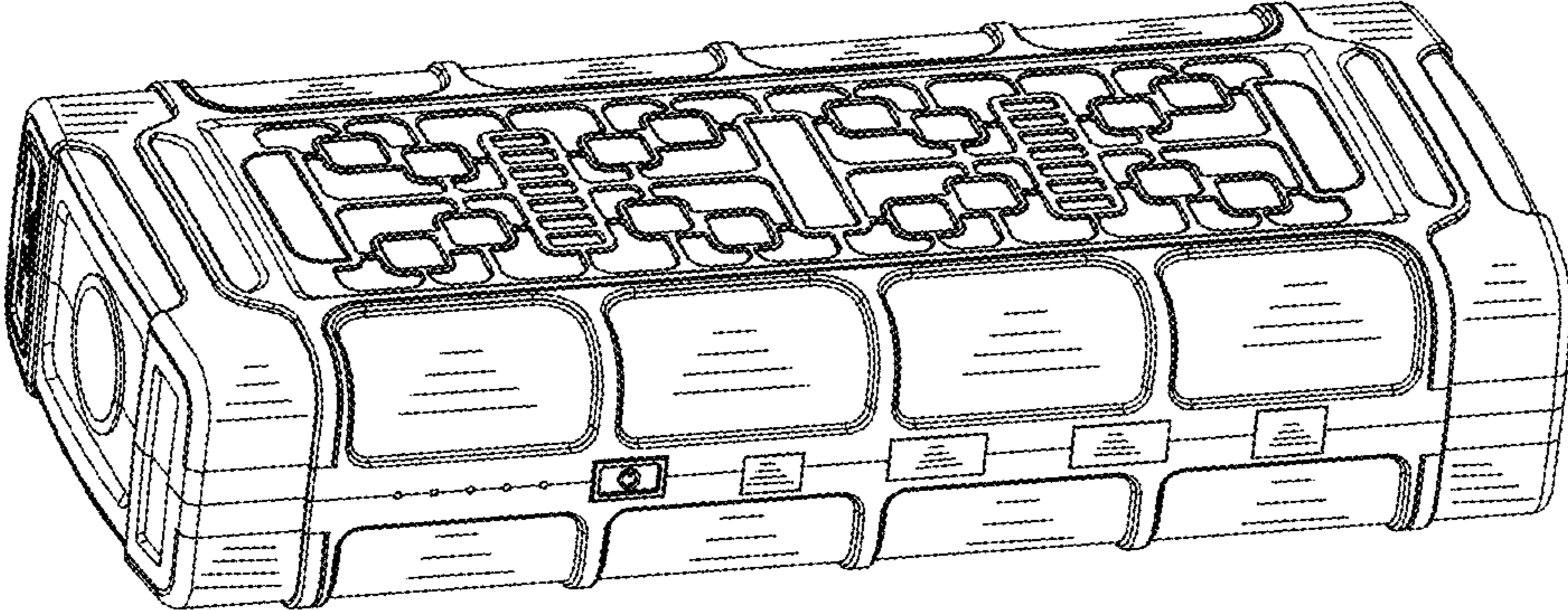

FIG. 7

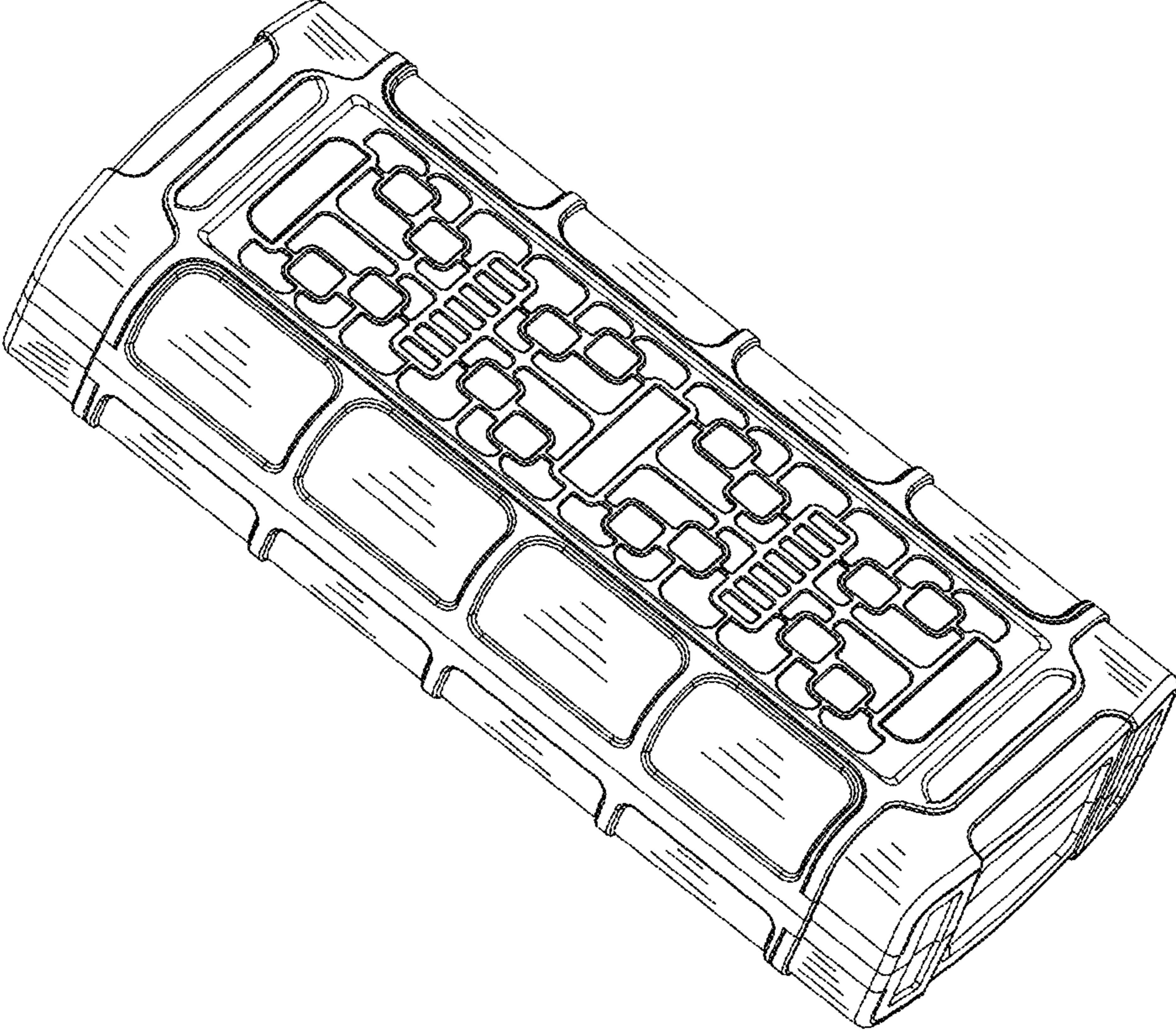

FIG. 8