



US00D785482S

(12) **United States Design Patent**
Schwamkrug

(10) **Patent No.:** **US D785,482 S**

(45) **Date of Patent:** **** May 2, 2017**

(54) **WATCH BAND**

(71) Applicant: **Porsche Lizenz- und
Handelsgesellschaft mbH & Co. KG,**
Bietigheim-Bissingen (DE)

(72) Inventor: **Christian Schwamkrug,** Zell am See
(AT)

(73) Assignee: **Porsche Lizenz- und
Handelsgesellschaft mbH & Co. KG,**
Bietigheim-Bissingen (DE)

(**) Term: **14 Years**

(21) Appl. No.: **29/518,177**

(22) Filed: **Feb. 20, 2015**

(30) **Foreign Application Priority Data**

Sep. 1, 2014 (EM) 001420087

(51) **LOC (10) Cl.** **11-01**

(52) **U.S. Cl.**
USPC **D11/3**

(58) **Field of Classification Search**
USPC D11/1-3; D10/30-32, 38, 70; D14/344;
368/281, 282

CPC A44C 5/00; A44C 5/0053; A44C 15/0025;
Y10T 24/4782; Y10T 24/2155

See application file for complete search history.

(56) **References Cited**

U.S. PATENT DOCUMENTS

D474,983 S * 5/2003 Wunderman D10/32
D544,801 S * 6/2007 Hardy D10/32

D573,485 S * 7/2008 Kuchler D10/32
D573,899 S * 7/2008 Kuchler D10/32
D573,900 S * 7/2008 Kuchler D10/32
D580,277 S * 11/2008 Brady D10/32
D592,976 S * 5/2009 Kuchler D10/32
D709,476 S * 7/2014 Park D10/32
D711,760 S * 8/2014 Savoy D10/32
D716,247 S * 10/2014 Yun D10/32
D757,722 S * 5/2016 Akana D10/31
2013/0156977 A1 * 6/2013 Tragatschnig B43K 7/005
428/34.1

* cited by examiner

Primary Examiner — Cynthia Ramirez

Assistant Examiner — Llorellys Martinez-Rivera

(74) *Attorney, Agent, or Firm* — RatnerPrestia

(57) **CLAIM**

The ornamental design for a watch band, as shown and described.

DESCRIPTION

FIG. 1 is a top perspective view of a watch band showing my new design;
FIG. 2 is a top plan view thereof;
FIG. 3 is a bottom plan view thereof; and,
FIG. 4 is a bottom perspective view thereof.
The broken lines shown in FIGS. 1 through 4 illustrate environmental subject matter only and form no part of the claimed design.

1 Claim, 4 Drawing Sheets

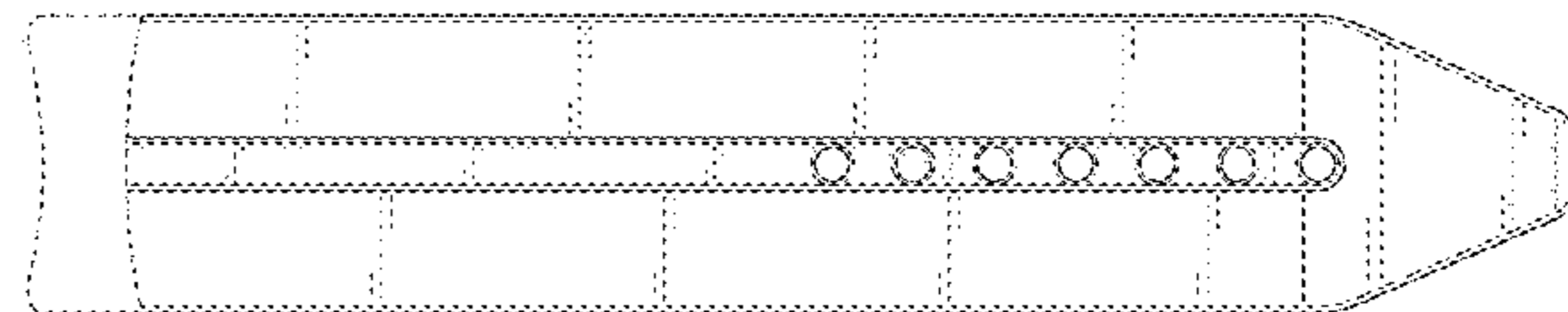
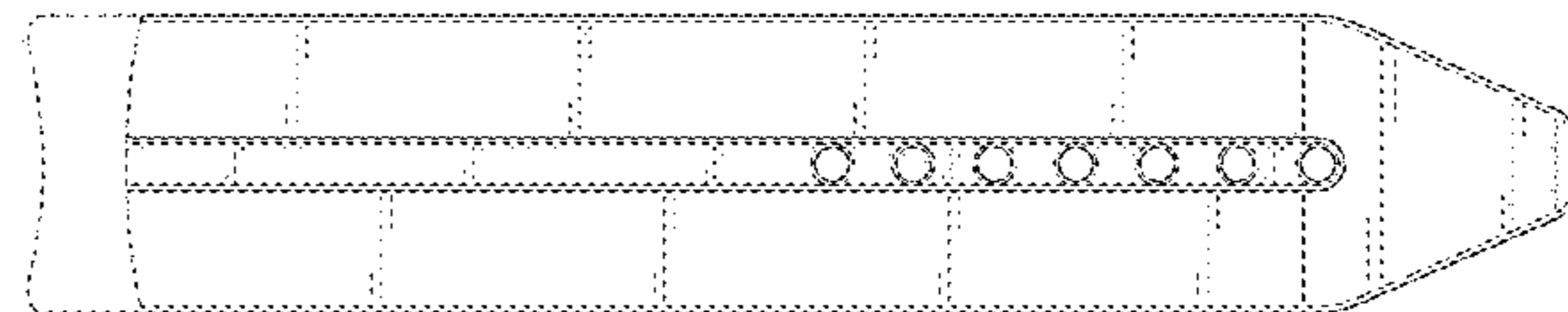
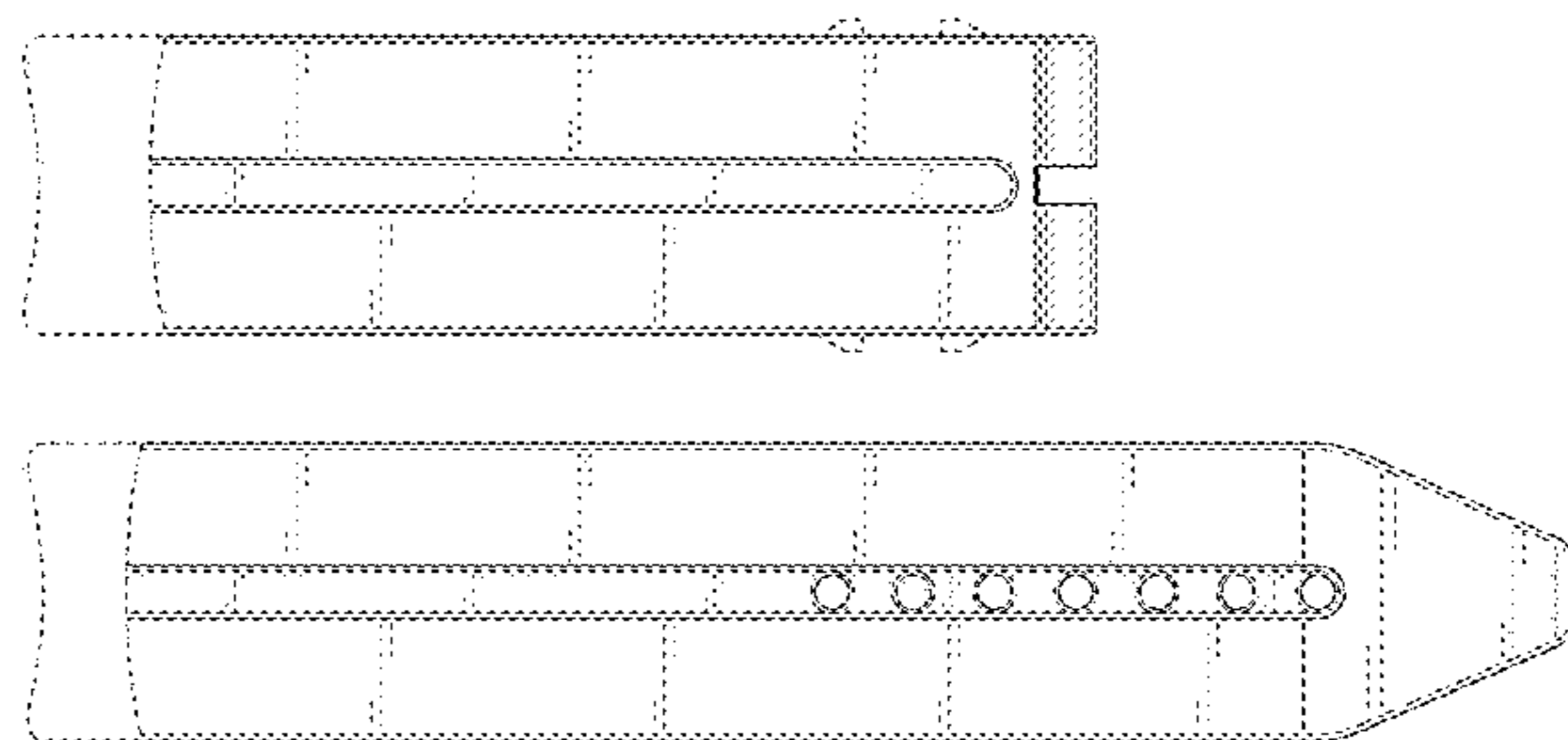
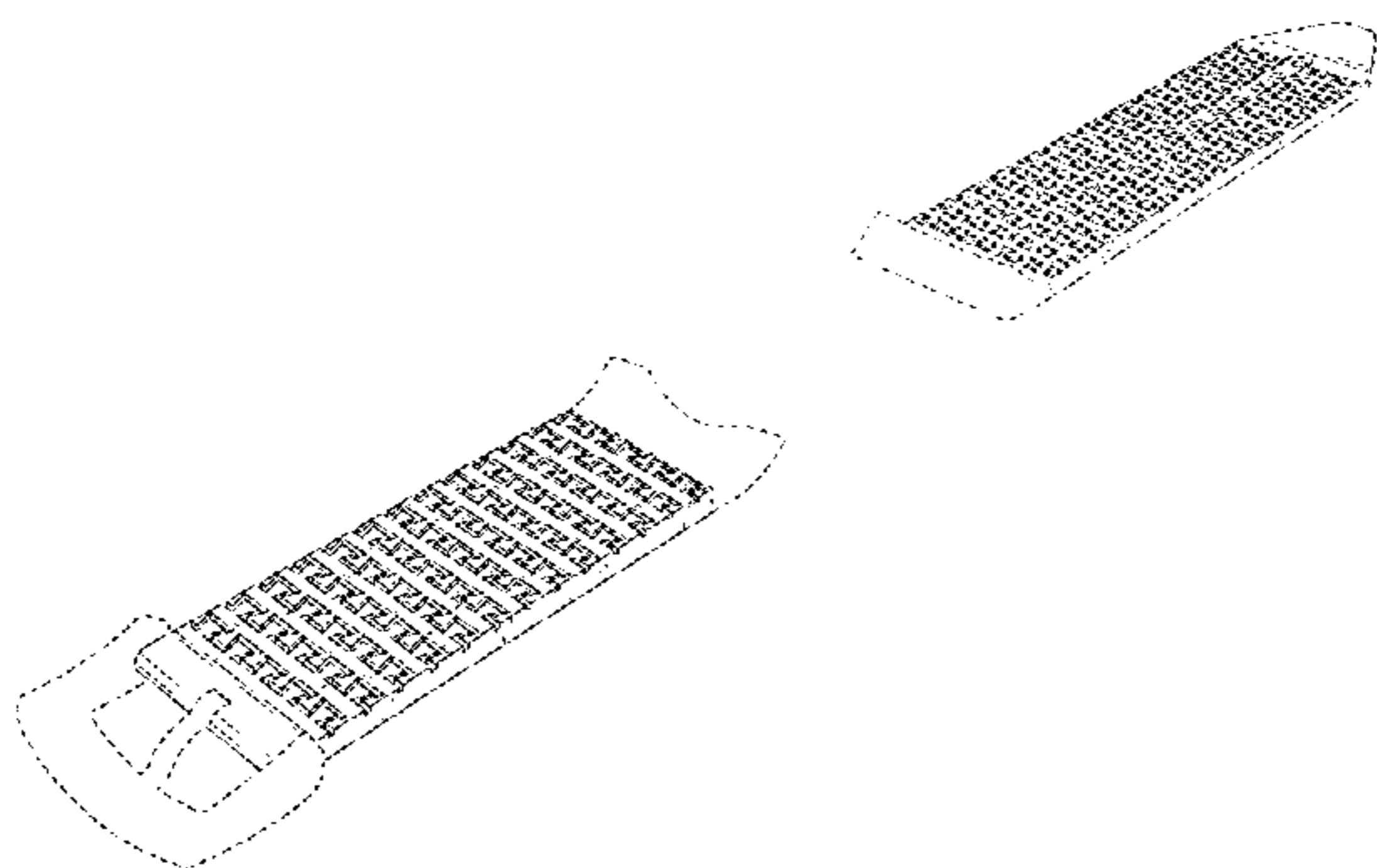

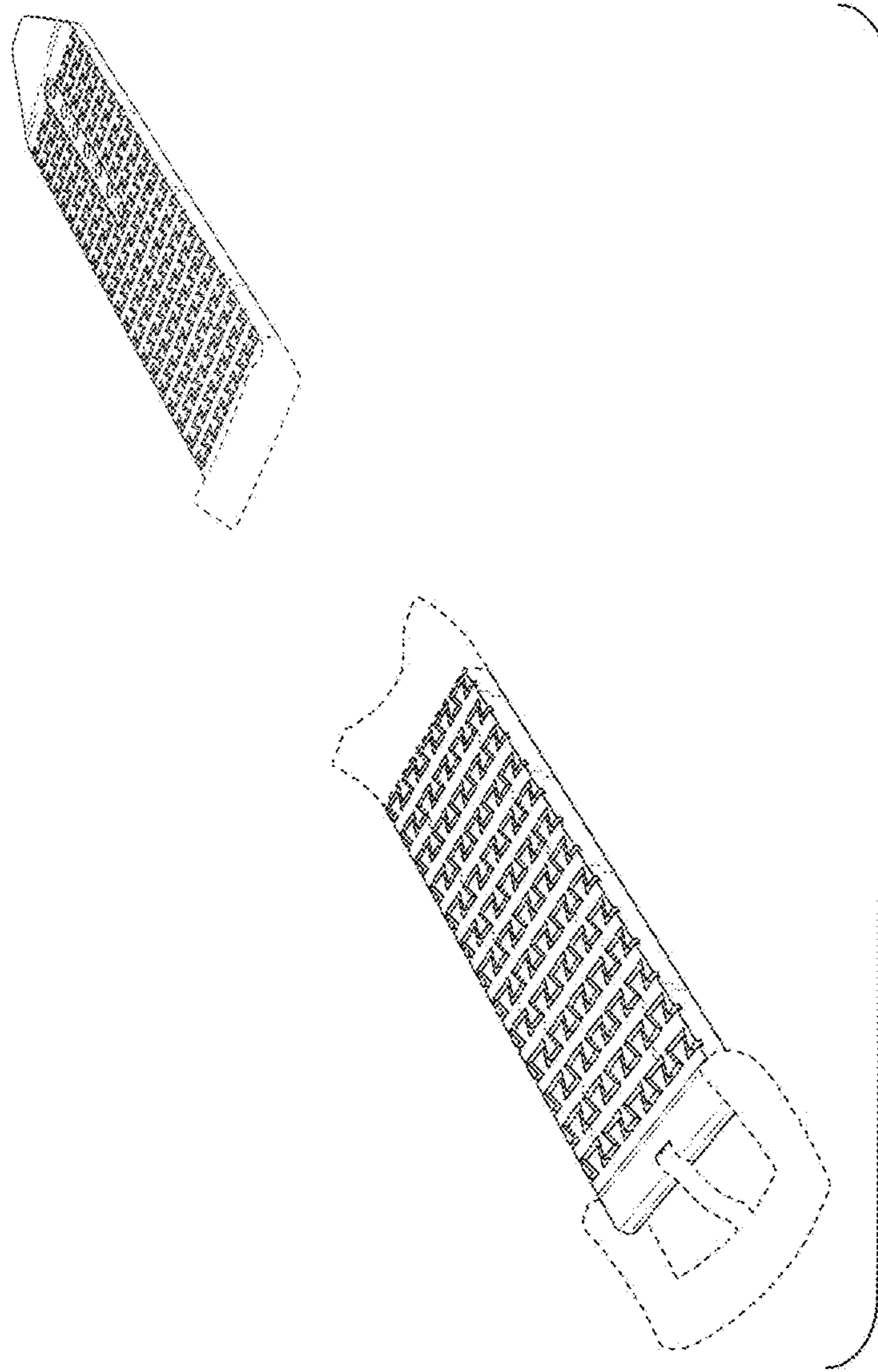

FIG. 1

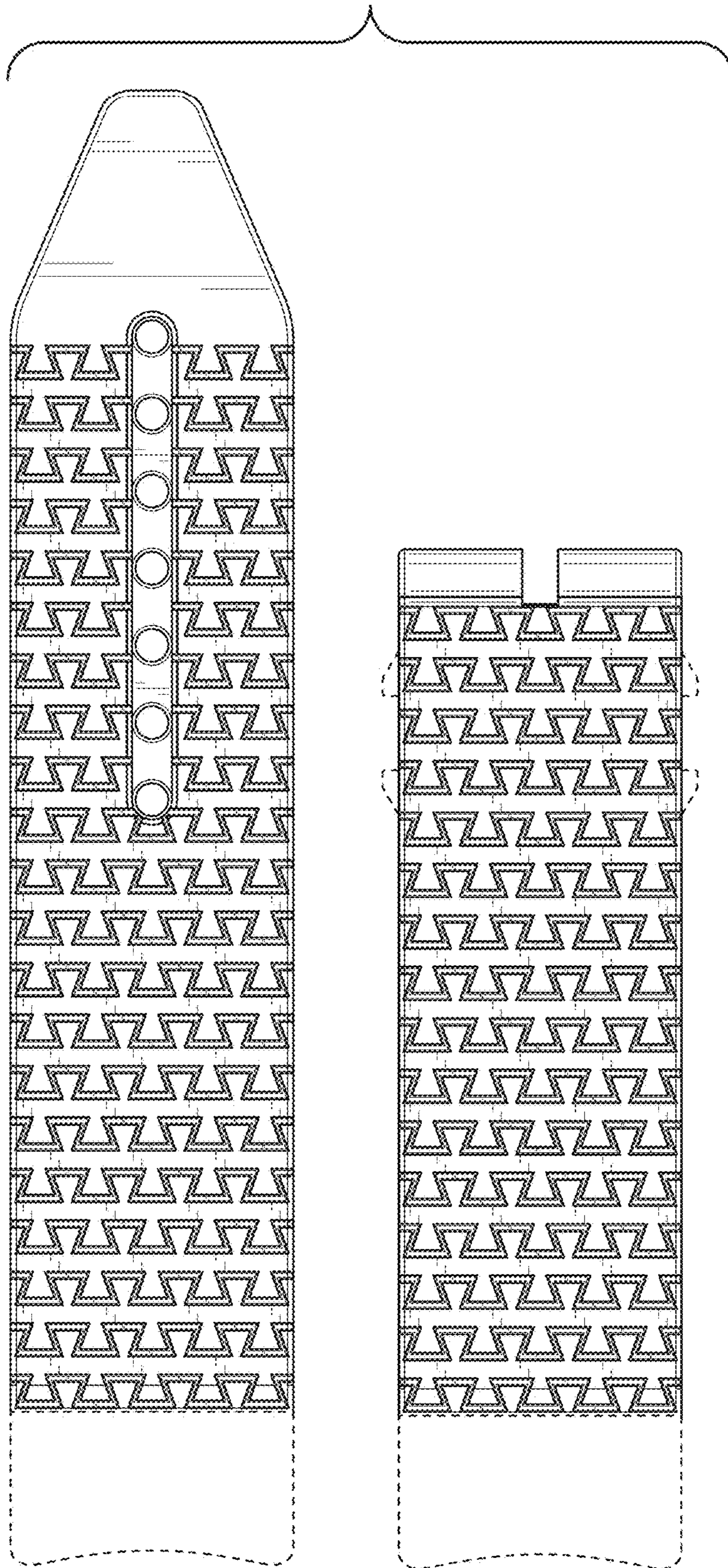

FIG. 2

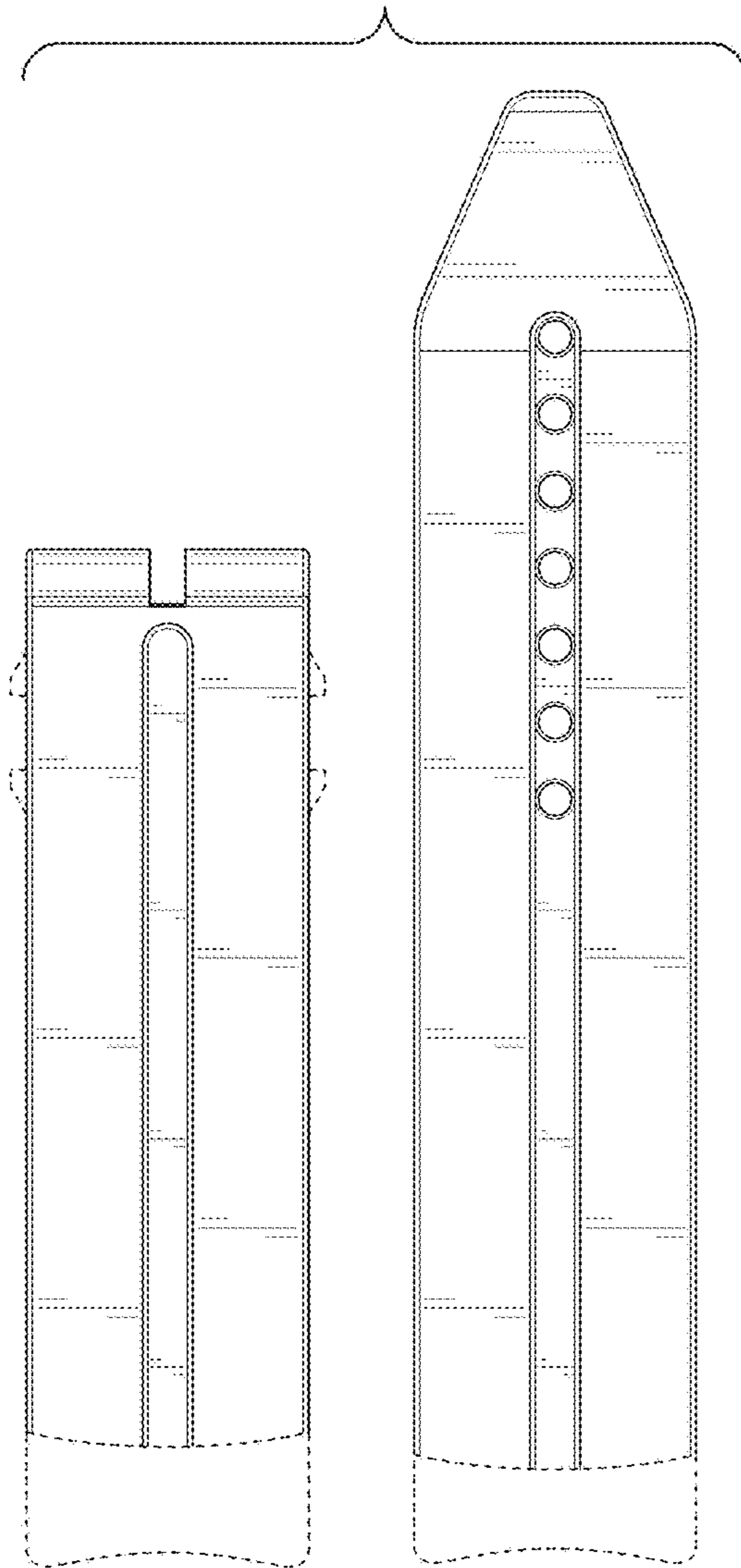

FIG. 3

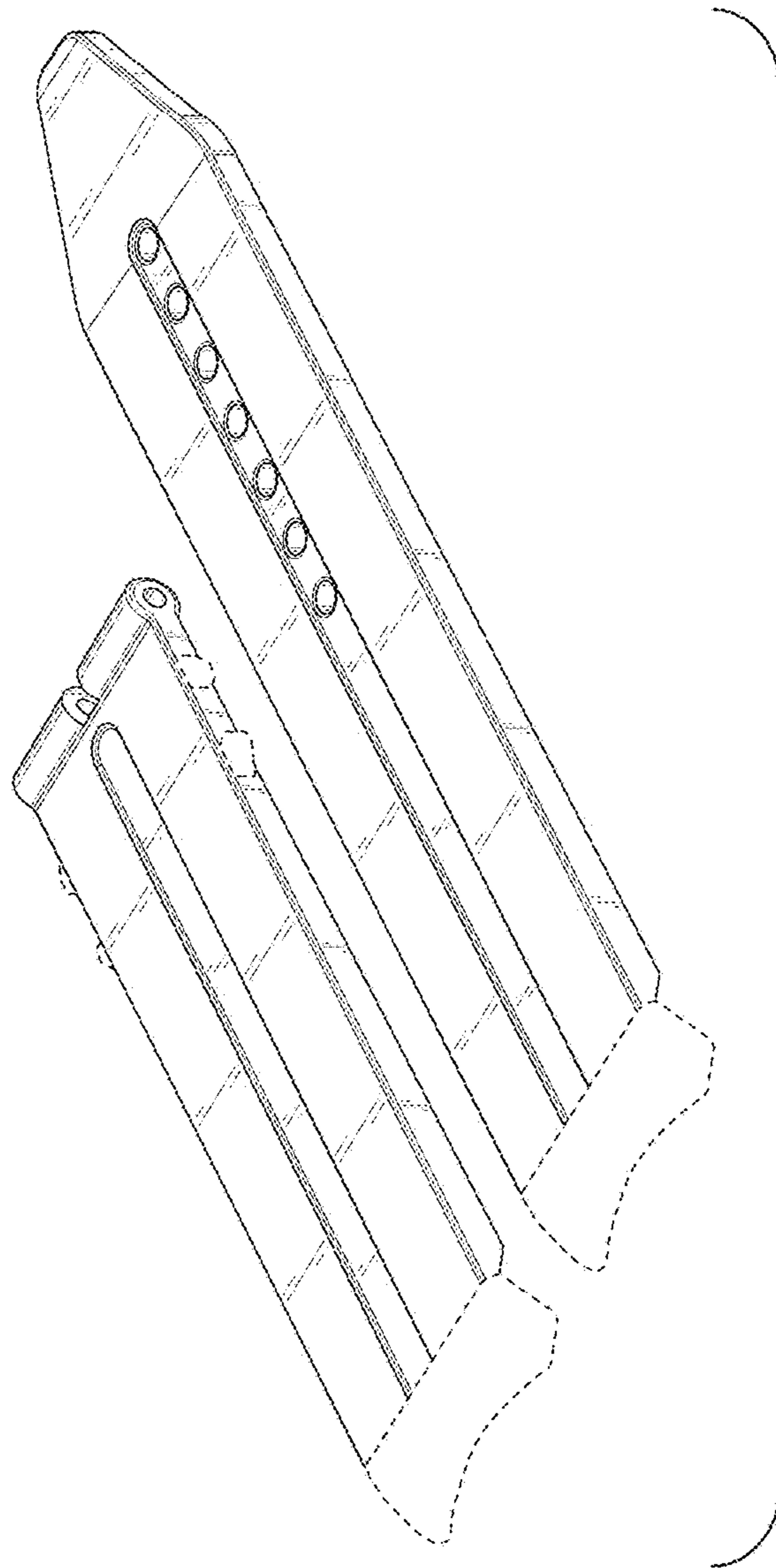

FIG. 4