



US00D785446S

(12) **United States Design Patent** (10) **Patent No.:** **US D785,446 S**  
**Fratianne** (45) **Date of Patent:** **\*\* May 2, 2017**

(54) **PILLARED ENDCAP**  
(71) Applicant: **Gary Fratianne**, Avon Lake, OH (US)  
(72) Inventor: **Gary Fratianne**, Avon Lake, OH (US)  
(73) Assignee: **Gary Fratianne**, Avon Lake, OH (US)  
(\*\*) Term: **15 Years**  
(21) Appl. No.: **29/546,355**  
(22) Filed: **Nov. 20, 2015**  
(51) **LOC (10) Cl.** ..... **08-99**  
(52) **U.S. Cl.**  
USPC ..... **D8/499**; D8/346  
(58) **Field of Classification Search**  
USPC ..... D8/330, 331, 346, 349, 400, 404, 499,  
D8/382, 383; 70/14, 51, 54-56, 431,  
70/466; 292/253, 256, 289, 341.14, 340;  
52/80.1, 80.2, 81.3, 465; 411/373  
CPC ..... E04B 1/18; E04B 1/32; E05B 9/00; E05B  
9/002; E05B 67/02  
See application file for complete search history.

3,199,322 A \* 8/1965 Braun ..... E05B 83/24  
292/123  
D350,473 S \* 9/1994 Simon ..... D8/346  
D396,407 S \* 7/1998 Jennings ..... D8/400  
D453,900 S \* 2/2002 Zapf ..... D8/499  
D465,720 S \* 11/2002 Persson ..... D8/331  
D557,109 S \* 12/2007 Navin ..... D8/346  
D557,587 S \* 12/2007 Navin ..... D8/346  
D704,034 S \* 5/2014 Larsen ..... D8/346

\* cited by examiner

*Primary Examiner* — Prabhakar Deshmukh  
(74) *Attorney, Agent, or Firm* — Richard M. Klein; Fay  
Sharpe LLP

(57) **CLAIM**

The ornamental design for a pillared endcap, as shown and described.

**DESCRIPTION**

FIG. 1 is a front left perspective view of a left-side endcap. FIG. 2 is a front right perspective view of the left-side endcap. FIG. 3 is a front view of the left-side endcap. FIG. 4 is a left side view of the left-side endcap. FIG. 5 is a right side view of the left-side endcap; and, FIG. 6 is a rear view of the left-side endcap. The broken lines of FIGS. 1-6 illustrate portions of the article and form no part of the claimed design.

**1 Claim, 3 Drawing Sheets**

(56) **References Cited**

U.S. PATENT DOCUMENTS

D109,697 S \* 5/1938 Cody ..... D8/499  
2,772,086 A \* 11/1956 Foster ..... F16F 1/18  
267/158  
3,192,551 A \* 7/1965 Appel ..... B60S 1/38  
15/250.43

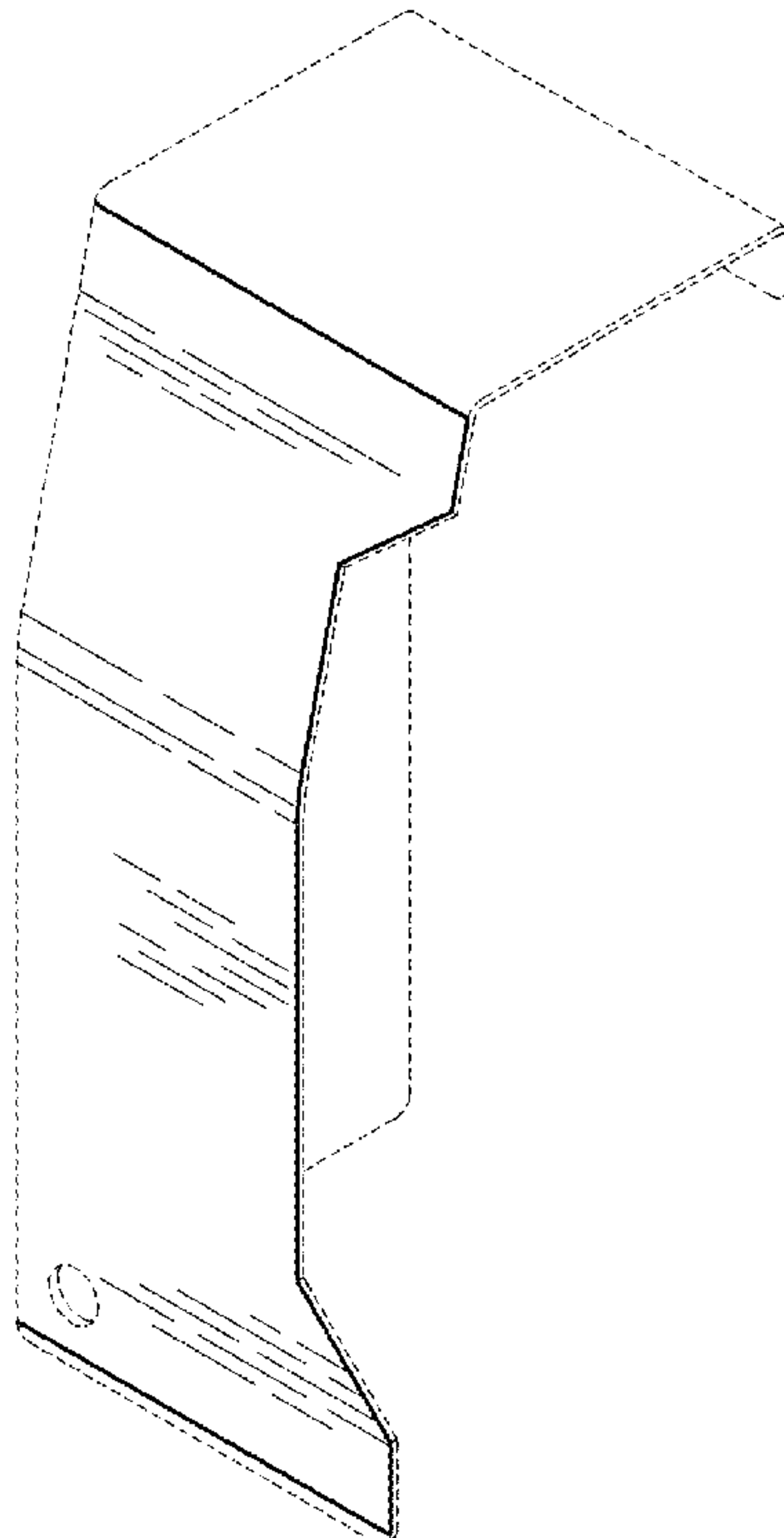

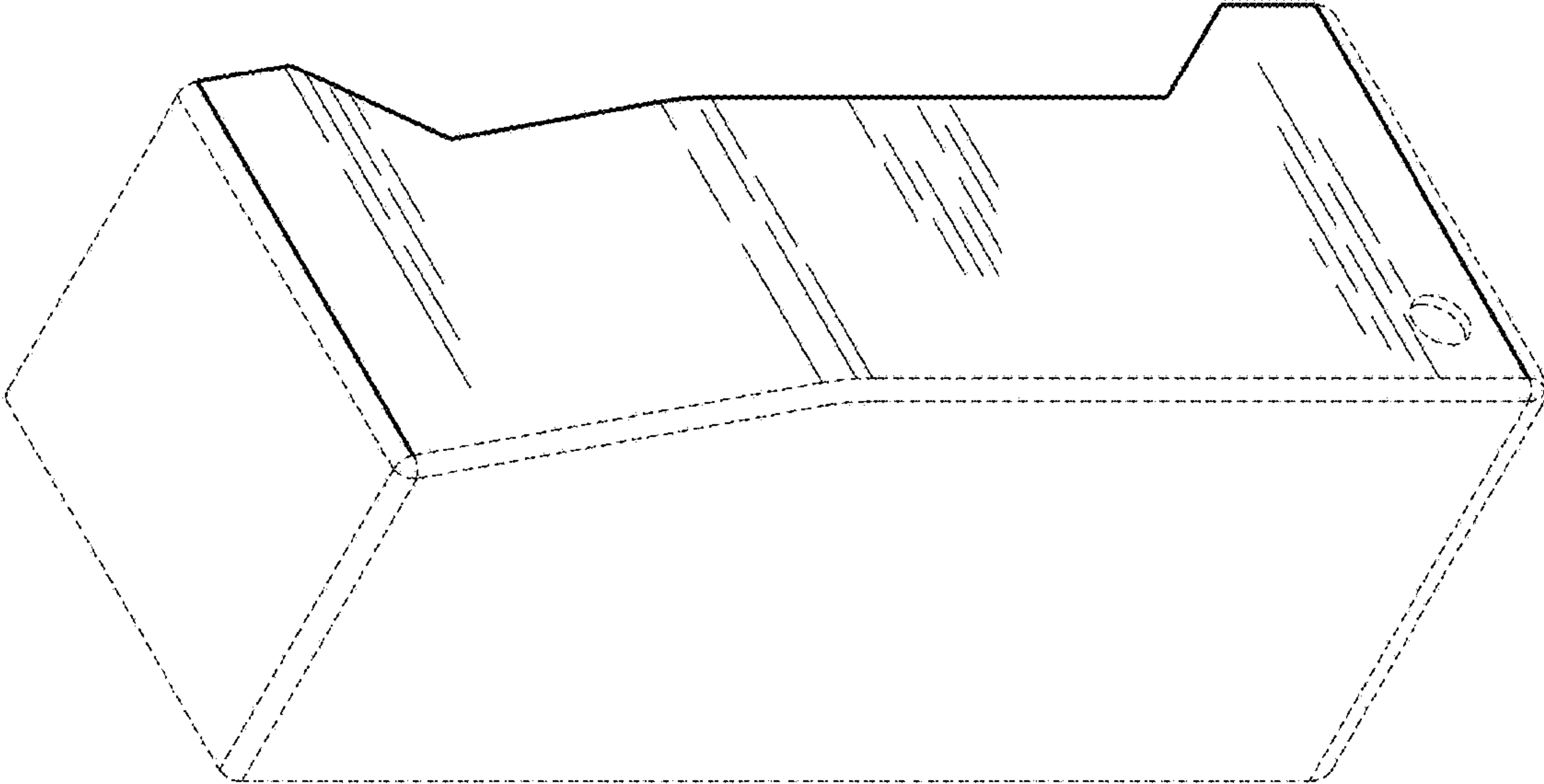

Fig. 2

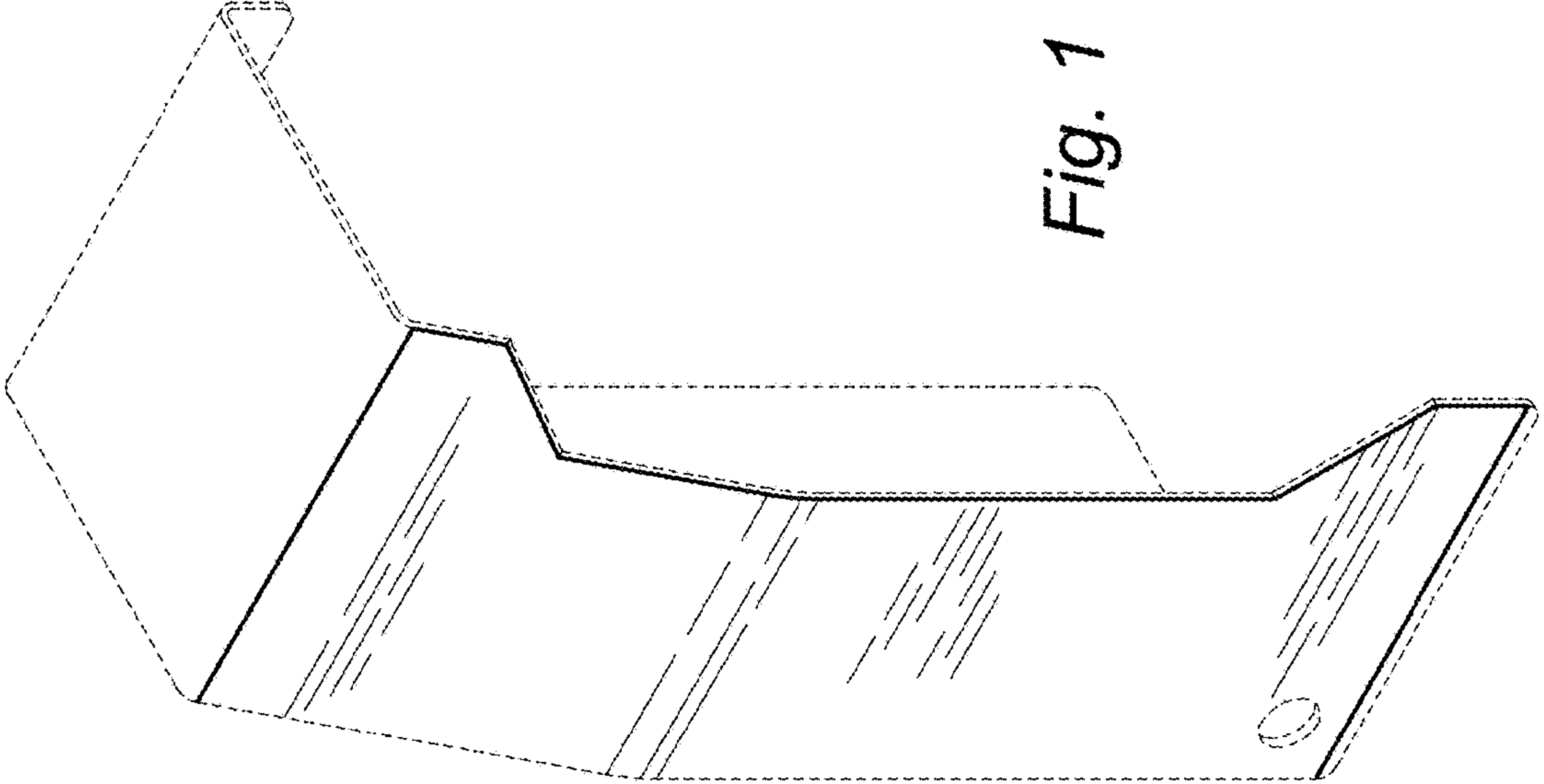

Fig. 1

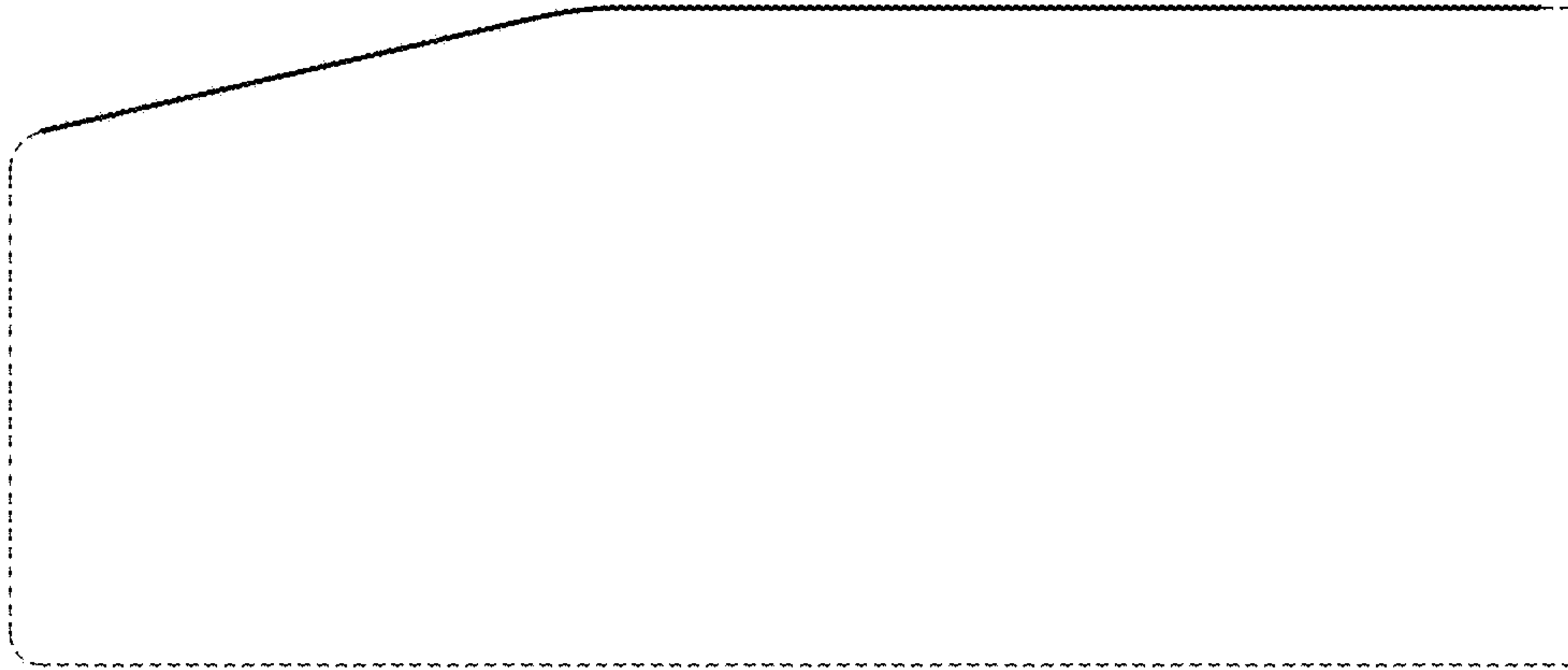

Fig. 5

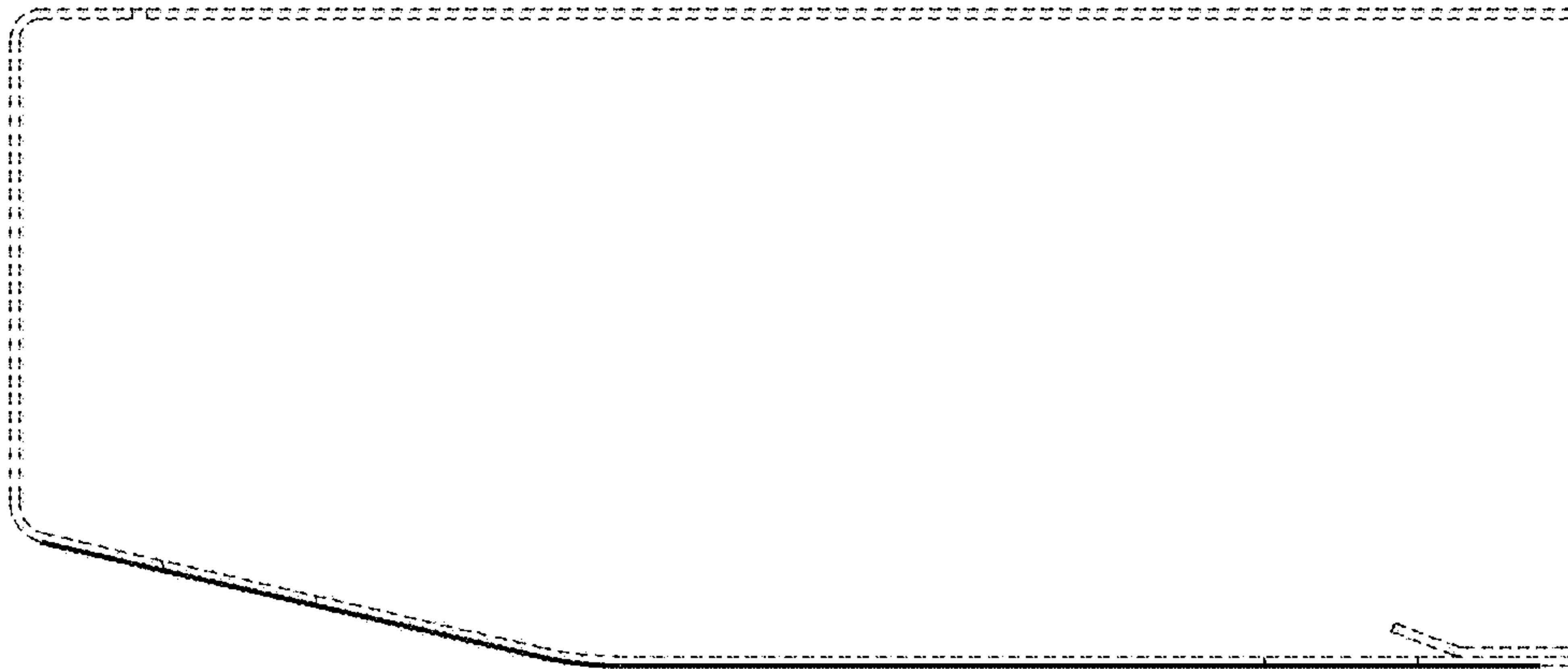

Fig. 4

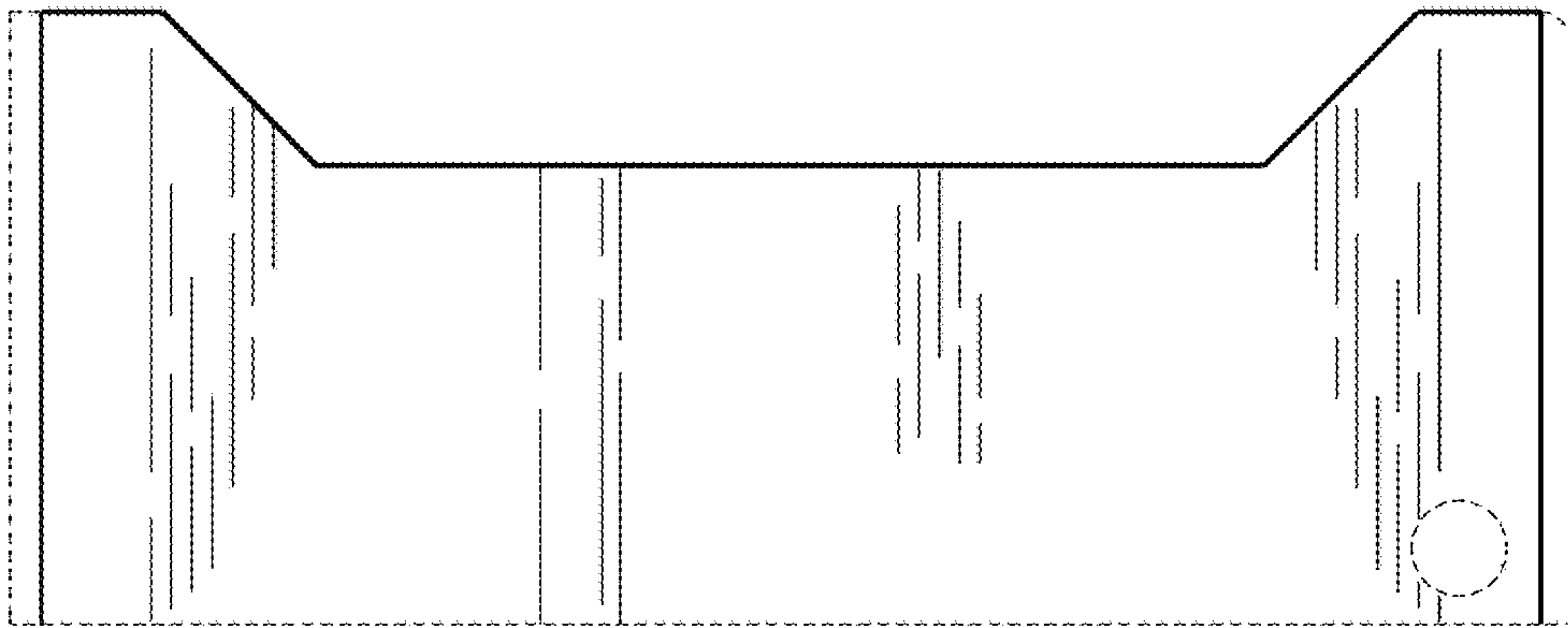

Fig. 3

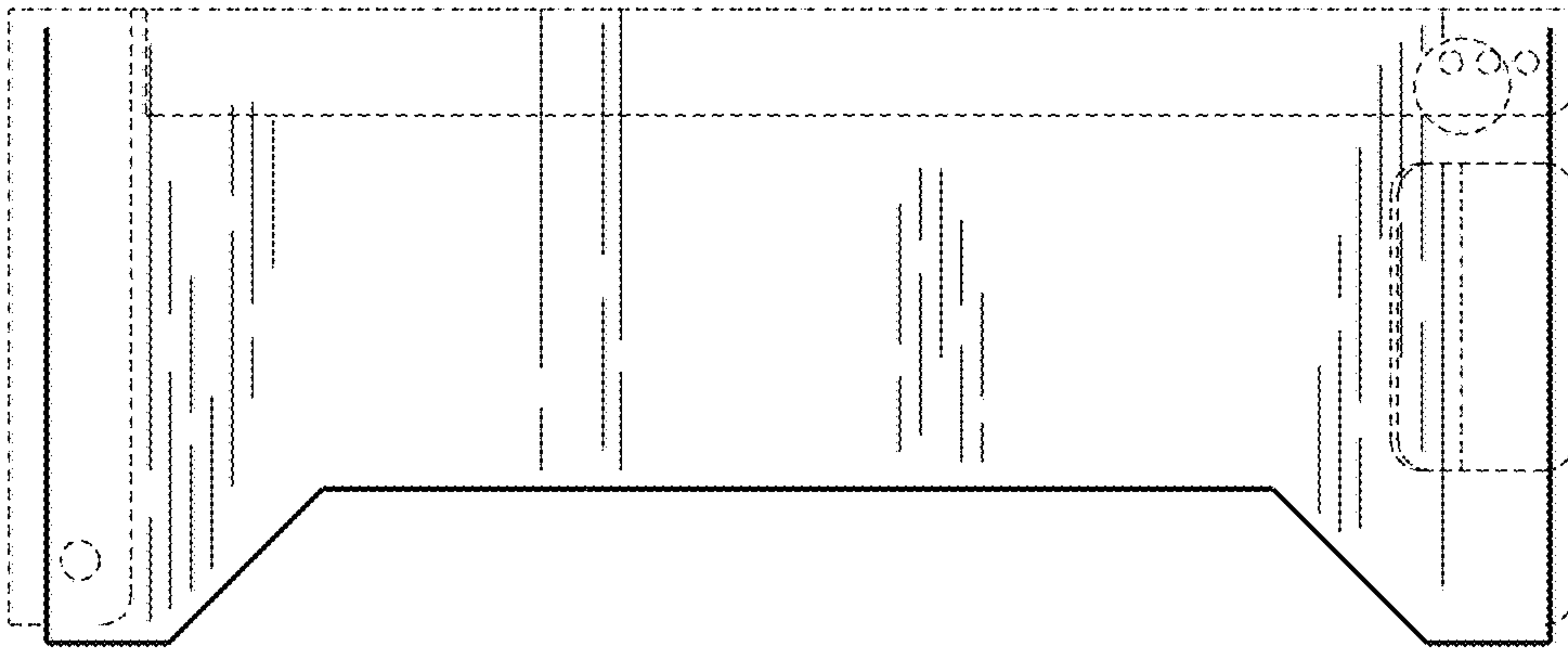

Fig. 6