

US00D785412S

(12) **United States Design Patent** (10) **Patent No.:** **US D785,412 S**
Petre (45) **Date of Patent:** **** May 2, 2017**

(54) **INSULATED GROWLER FOR CONTAINING A LIQUID**

D672,609 S * 12/2012 Aziz D7/507
D689,331 S * 9/2013 Staton D7/510
D690,559 S * 10/2013 Lane D7/510
D702,506 S * 4/2014 Mettler D7/608

(71) Applicant: **Outdoor Recreation Company of America, LLC**, Nashville, TN (US)

* cited by examiner

(72) Inventor: **Stephen J. Petre**, Maryville, TN (US)

Primary Examiner — Terry Wallace

(73) Assignee: **Outdoor Recreation Company of America, LLC**, Nashville, TN (US)

(74) *Attorney, Agent, or Firm* — Luedeka Neely Group, P.C.

(**) Term: **15 Years**

(57) **CLAIM**

(21) Appl. No.: **29/547,111**

The ornamental design of the insulated growler for containing liquids, as shown and described.

(22) Filed: **Dec. 1, 2015**

DESCRIPTION

(51) **LOC (10) Cl.** **07-01**

(52) **U.S. Cl.**
USPC **D7/608**

(58) **Field of Classification Search**
USPC D7/605–608, 510, 511; D9/503, 549, D9/531, 537, 556
CPC . F25D 2331/803; A47J 41/02; A47J 41/0077; B65D 1/0215; A47G 23/0216; A47G 23/0258
See application file for complete search history.

FIG. 1 is a perspective view of an insulated growler for containing liquids with the handle oriented away from the viewer at approximately 45° and with the lid closed; FIG. 2 is a perspective view of an insulated growler for containing liquids with the handle oriented toward the viewer at approximately 45° and with the lid open; FIG. 3 is a front view of the growler with the handle oriented behind the growler and hidden from view; FIG. 4 is a rear view of the growler with the handle oriented toward the viewer in front of the growler; FIG. 5 is a top view of the growler; FIG. 6 is a bottom view of the growler; and, FIG. 7 is a left side view of the growler which is a mirror image of the right side view of the growler.

(56) **References Cited**

U.S. PATENT DOCUMENTS

D644,489 S * 9/2011 Trombly D7/510
D651,044 S * 12/2011 Gilbert D7/510

1 Claim, 6 Drawing Sheets

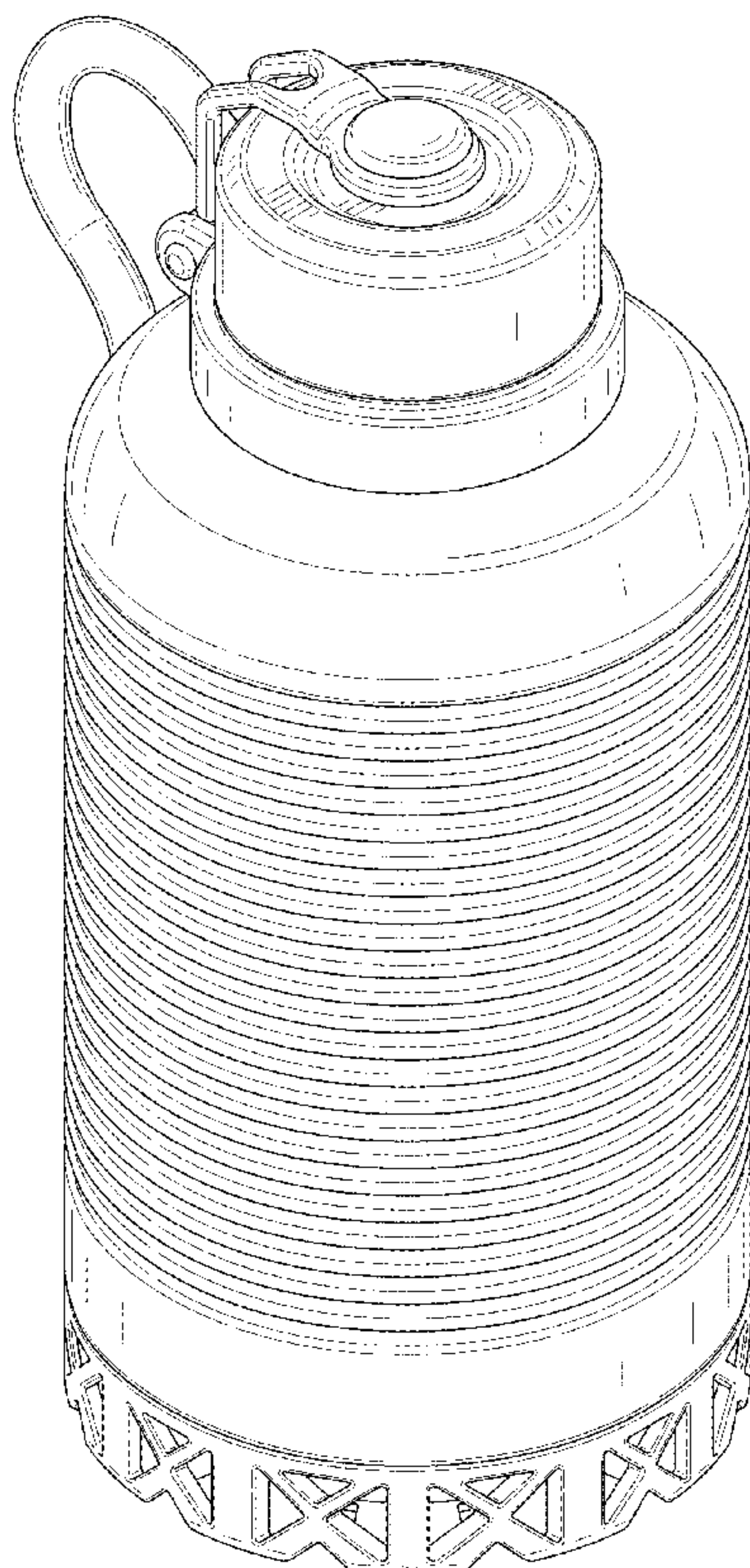

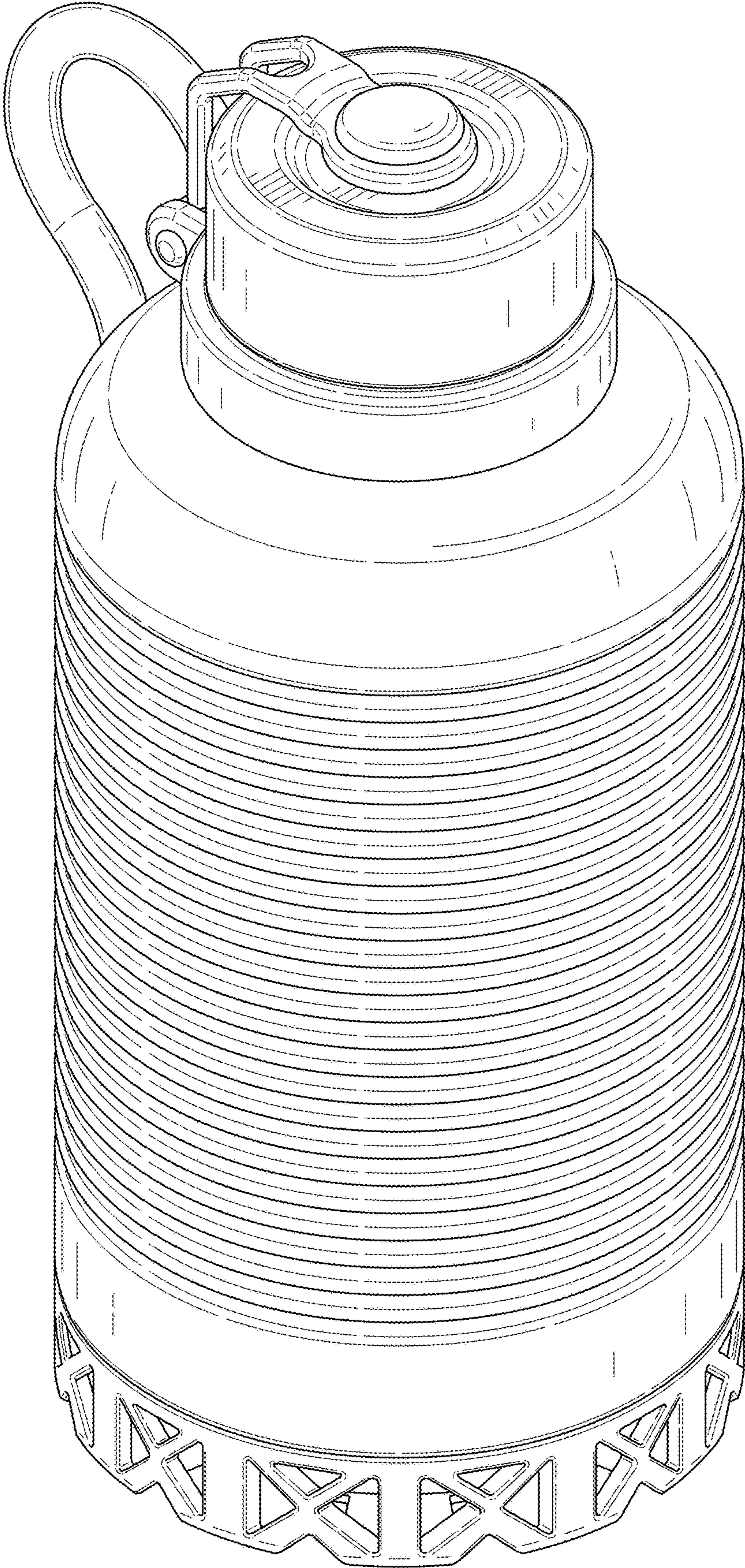

FIG. 1

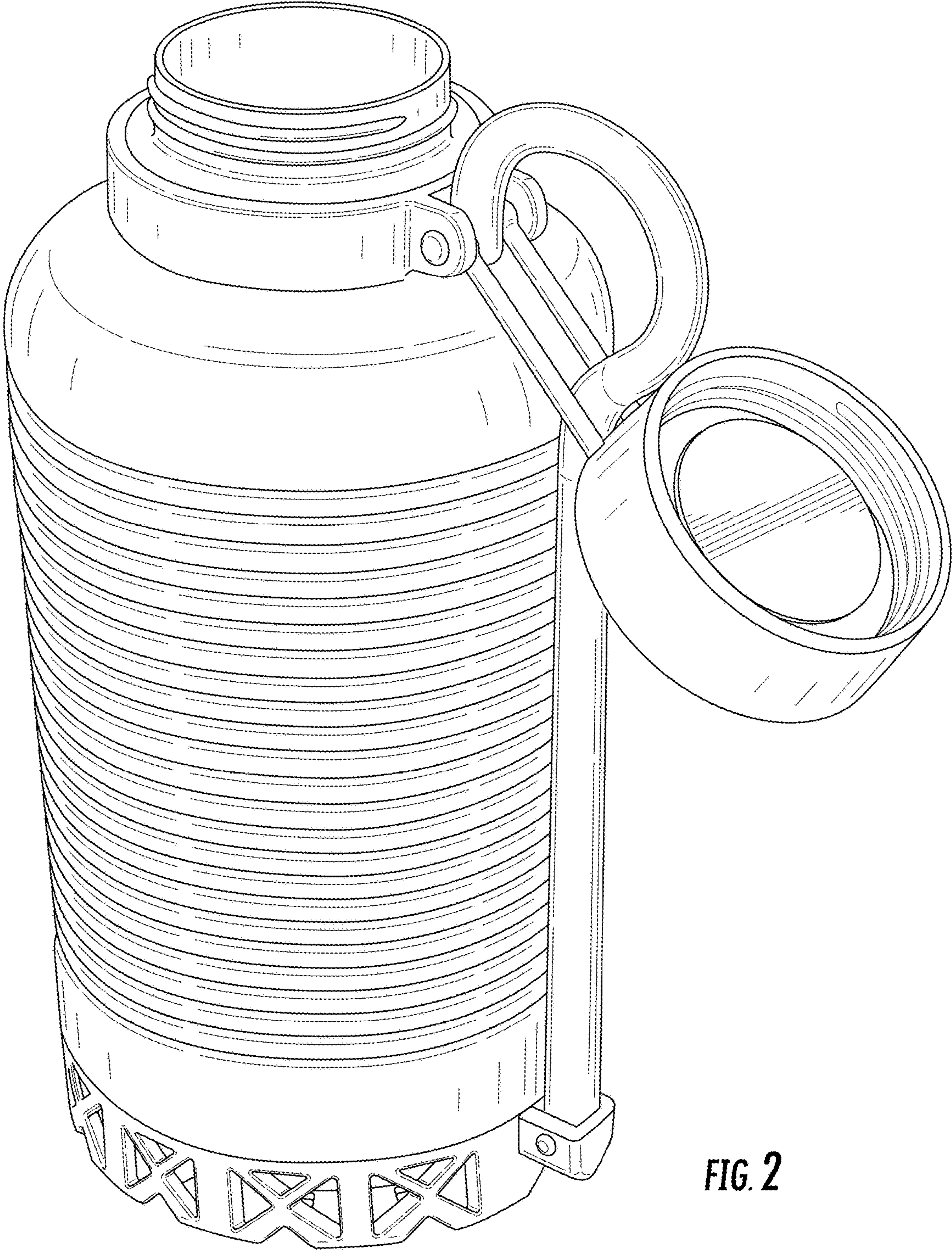

FIG. 2

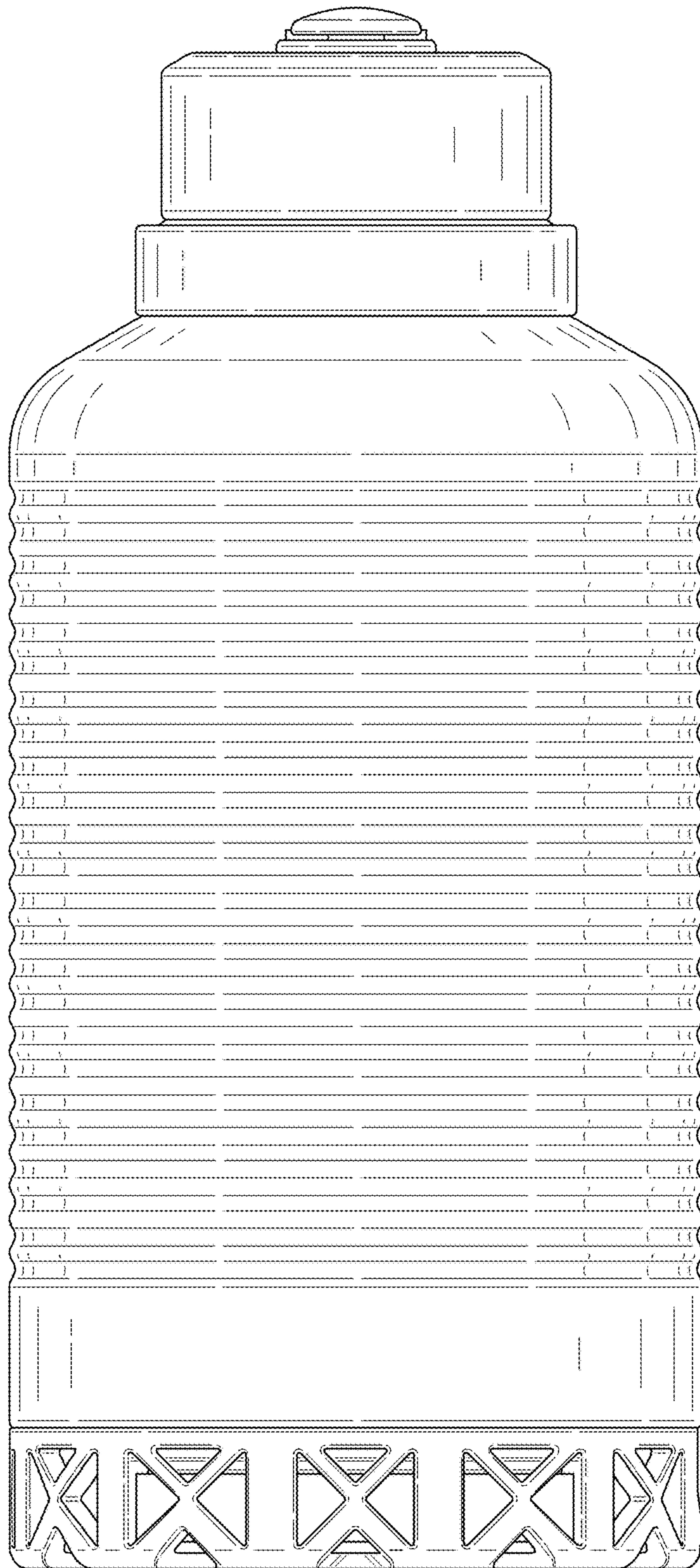

FIG. 3

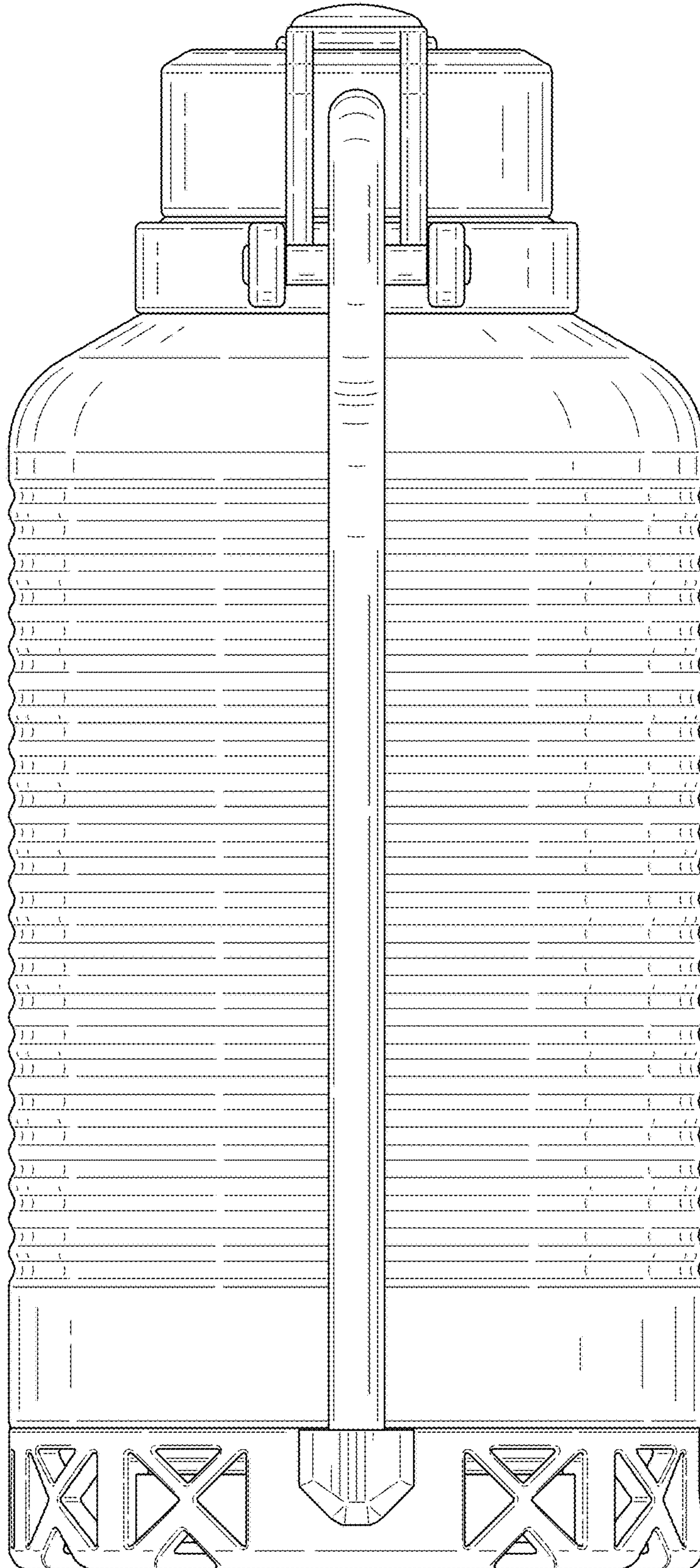

FIG. 4

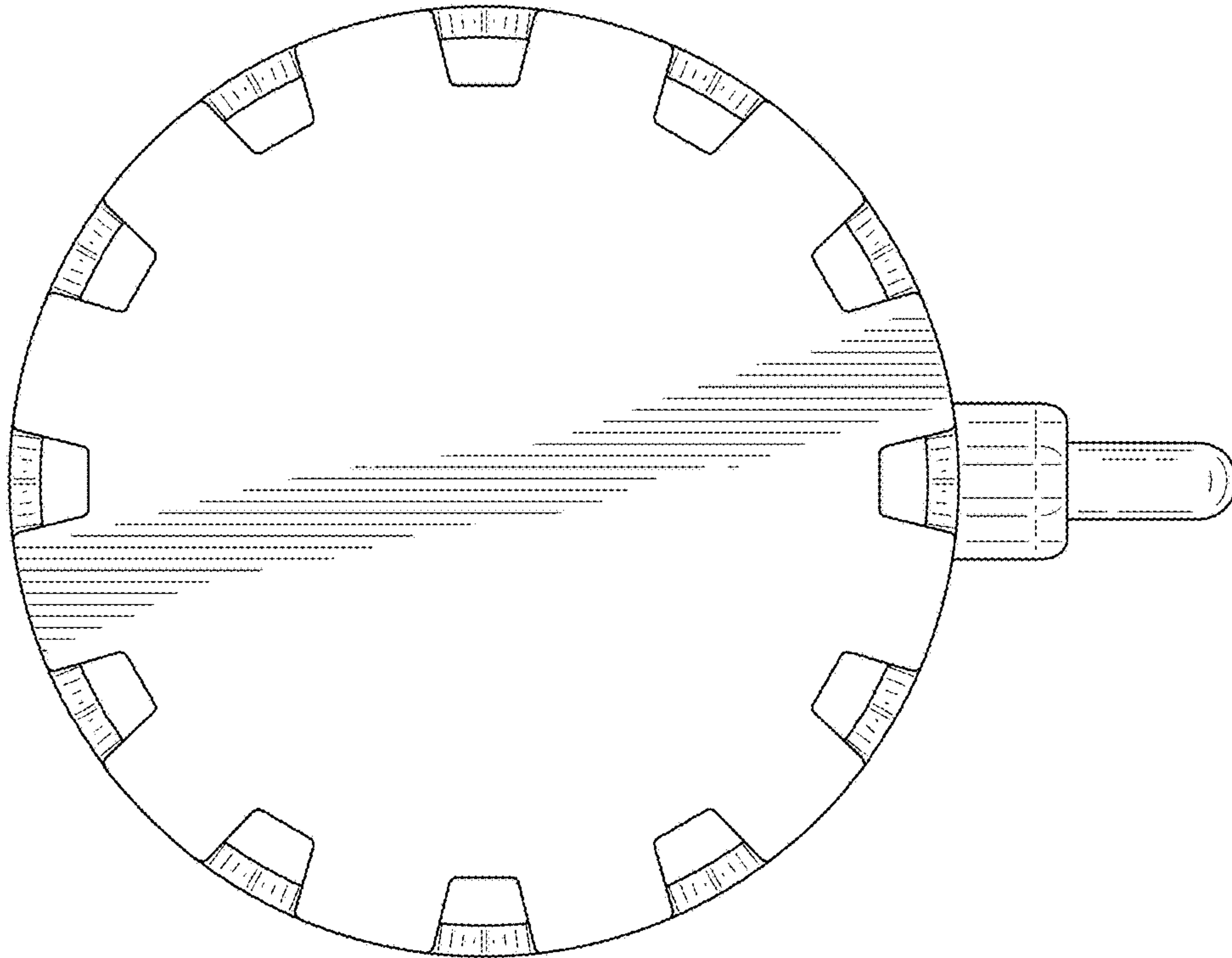

FIG. 6

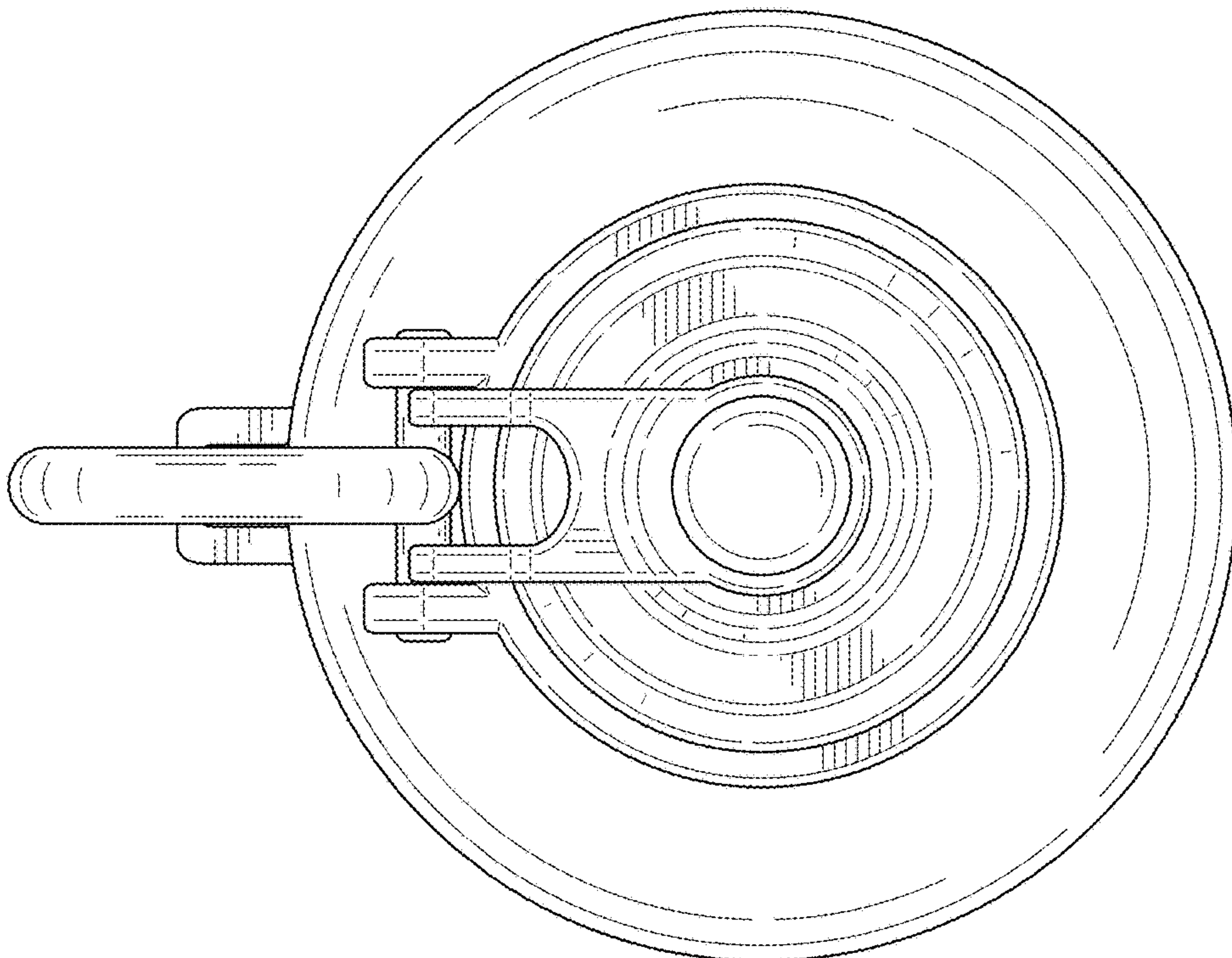

FIG. 5

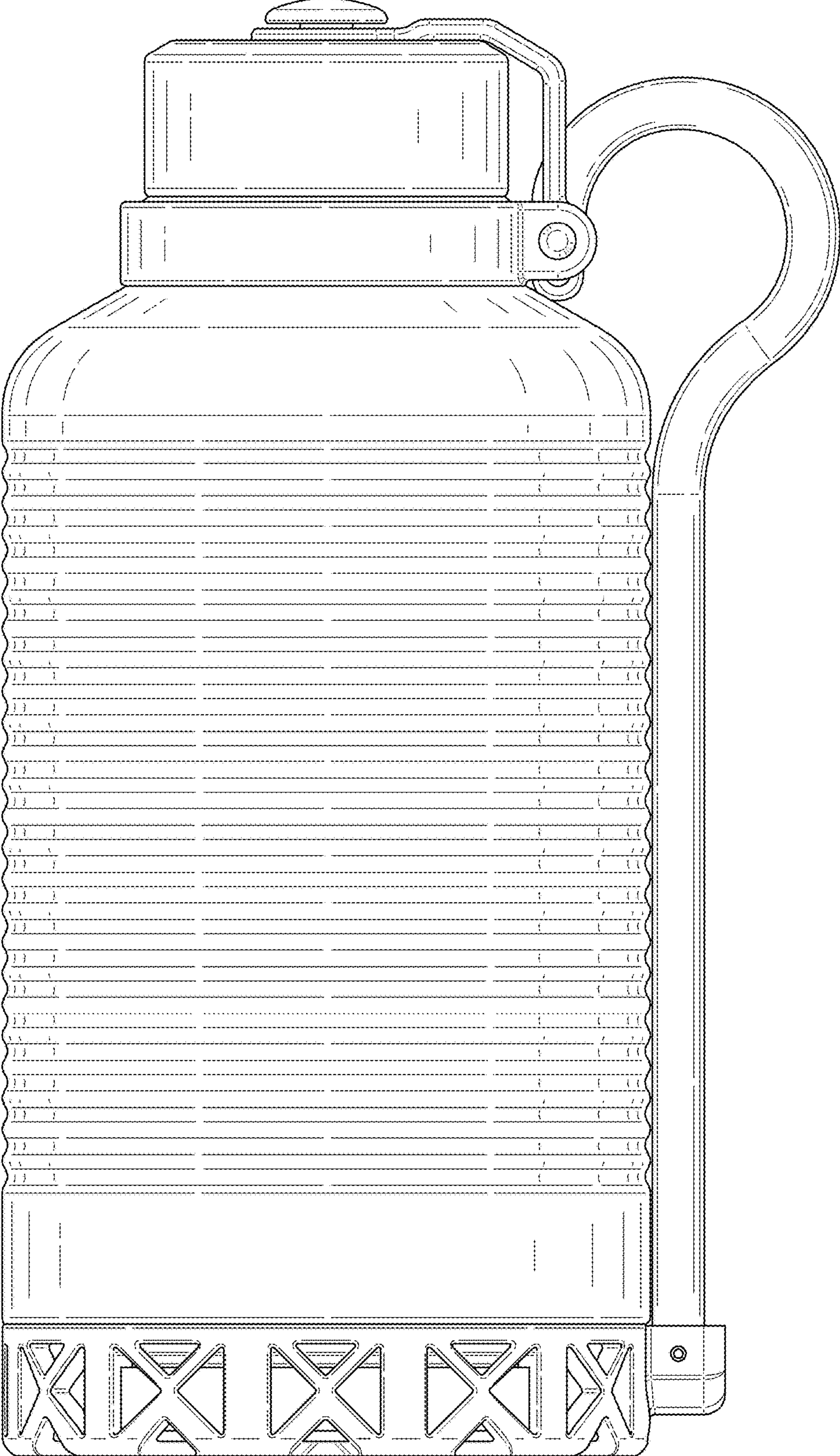

FIG. 7