



US00D785409S

(12) **United States Design Patent** (10) **Patent No.:** **US D785,409 S**
Japp (45) **Date of Patent:** **** May 2, 2017**

(54) **COMBINED LID HOLDER AND LIFTER**
 (71) Applicant: **Springbuck, LLC**, Bumpass, VA (US)
 (72) Inventor: **Johannes M. Japp**, Bumpass, VA (US)
 (73) Assignee: **Springbuck, LLC**, Bumpass, VA (US)
 (**) Term: **15 Years**

4,955,650 A * 9/1990 Davey A47J 45/10
 294/12
 D341,297 S * 11/1993 Martner D7/368
 D398,483 S * 9/1998 Stocco D7/601
 D589,756 S * 4/2009 Shaffer D7/601
 2006/0261021 A1* 11/2006 Stagnaro A47J 47/16
 211/119

(21) Appl. No.: **29/544,131**
 (22) Filed: **Oct. 30, 2015**
 (51) **LOC (10) Cl.** **07-04**
 (52) **U.S. Cl.**
 USPC **D7/601; D7/669**
 (58) **Field of Classification Search**
 USPC D7/680-696, 669, 368, 388; D8/14, 15,
 D8/33, 40, 45, 71, 88
 CPC A47J 45/10; A47J 47/16
 See application file for complete search history.

OTHER PUBLICATIONS

Photos of lifter design; 3 pages.

* cited by examiner

Primary Examiner — Terry Wallace
 (74) *Attorney, Agent, or Firm* — John H. Thomas, P.C.

(57) **CLAIM**

The ornamental design for a combined lid holder and lifter, as shown and described.

DESCRIPTION

FIG. 1 is a perspective view of a combined lid holder and lifter according to my design;
 FIG. 2 is a back view of the combined lid holder and lifter;
 FIG. 3 is a front view of the combined lid holder and lifter;
 FIG. 4 is a right side view of the combined lid holder and lifter;
 FIG. 5 is a left side view of the combined lid holder and lifter;
 FIG. 6 is a top view of the combined lid holder and lifter;
 and,
 FIG. 7 is a bottom view of the combined lid holder and lifter.

(56) **References Cited**
 U.S. PATENT DOCUMENTS
 1,254,551 A * 1/1918 Tucker A47J 45/10
 294/27.1
 1,730,444 A * 10/1929 Anderson A47J 45/10
 294/3
 2,662,717 A * 12/1953 Johnson A47J 47/16
 211/32
 D279,161 S * 6/1985 Gould D7/395
 4,893,771 A * 1/1990 Kaneshiro A47J 47/16
 211/181.1

1 Claim, 7 Drawing Sheets

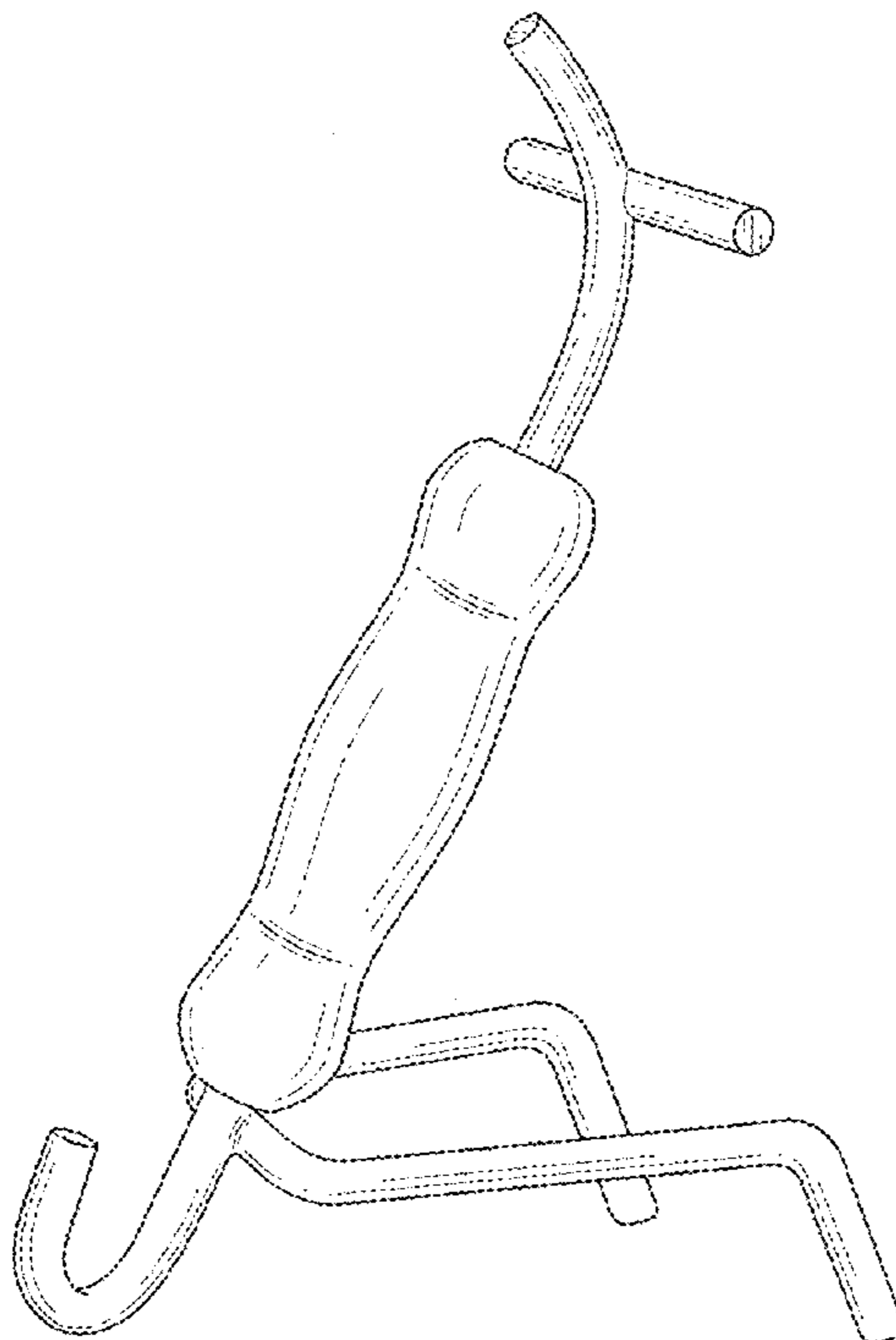

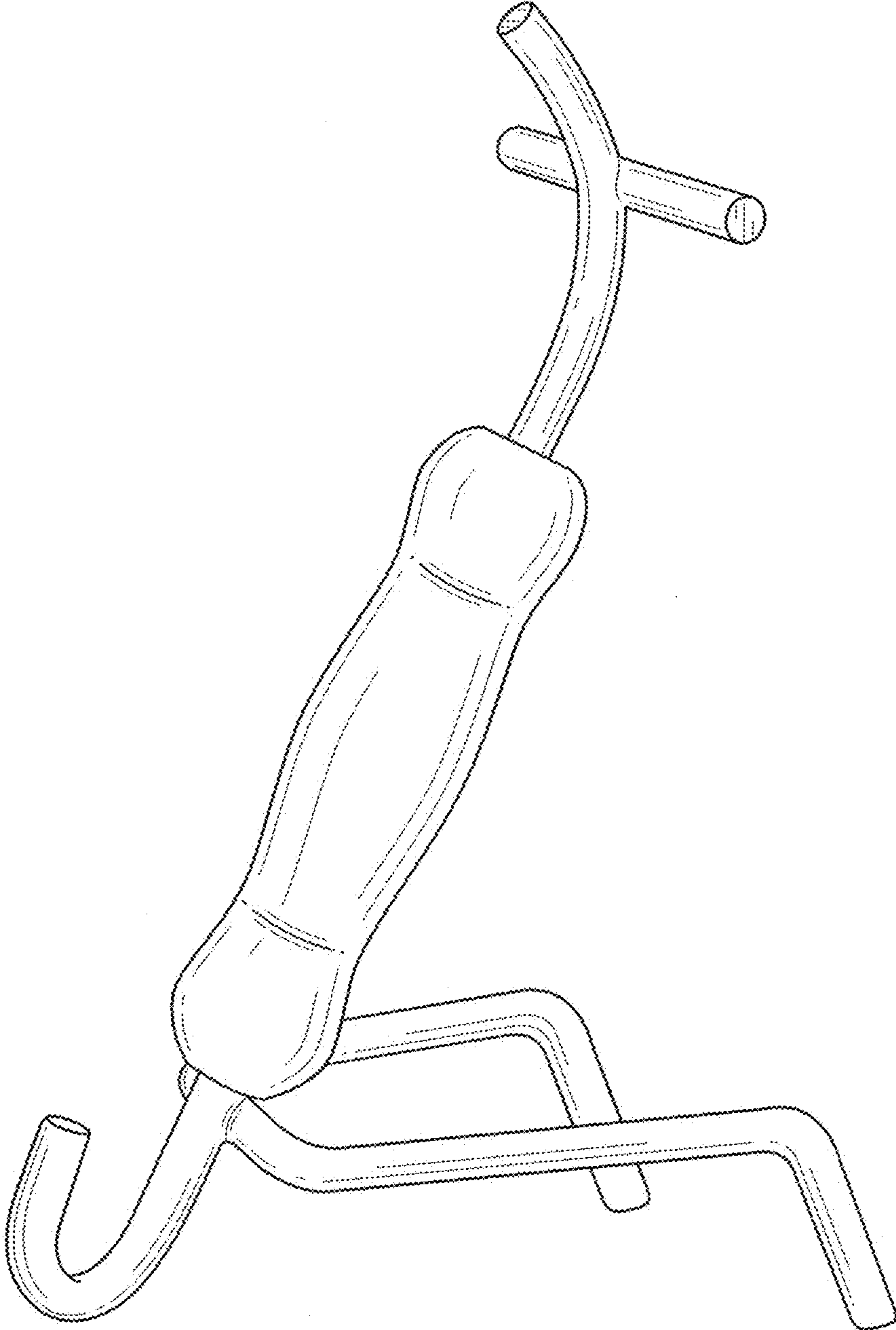

FIG. 1

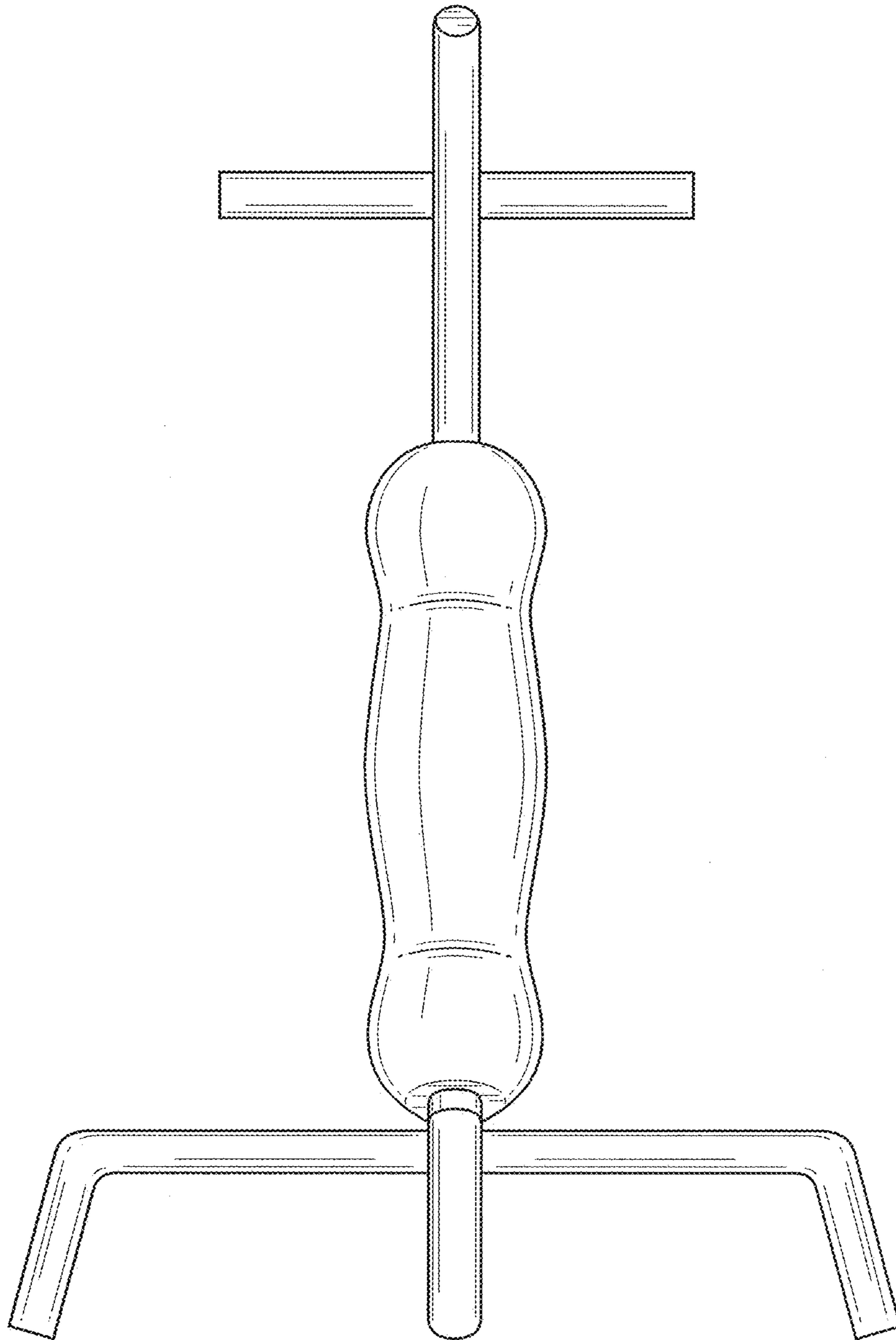

FIG. 2

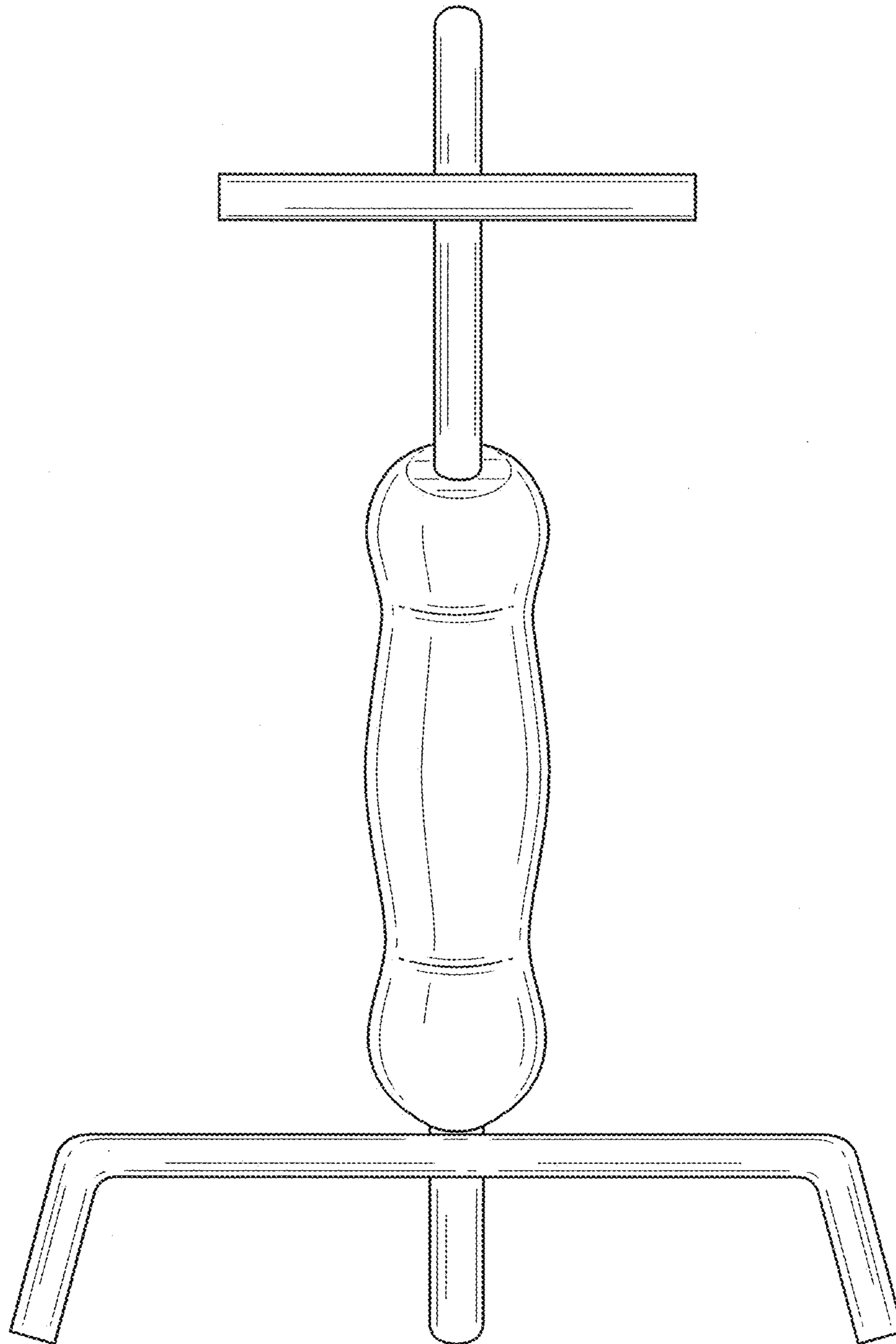

FIG. 3

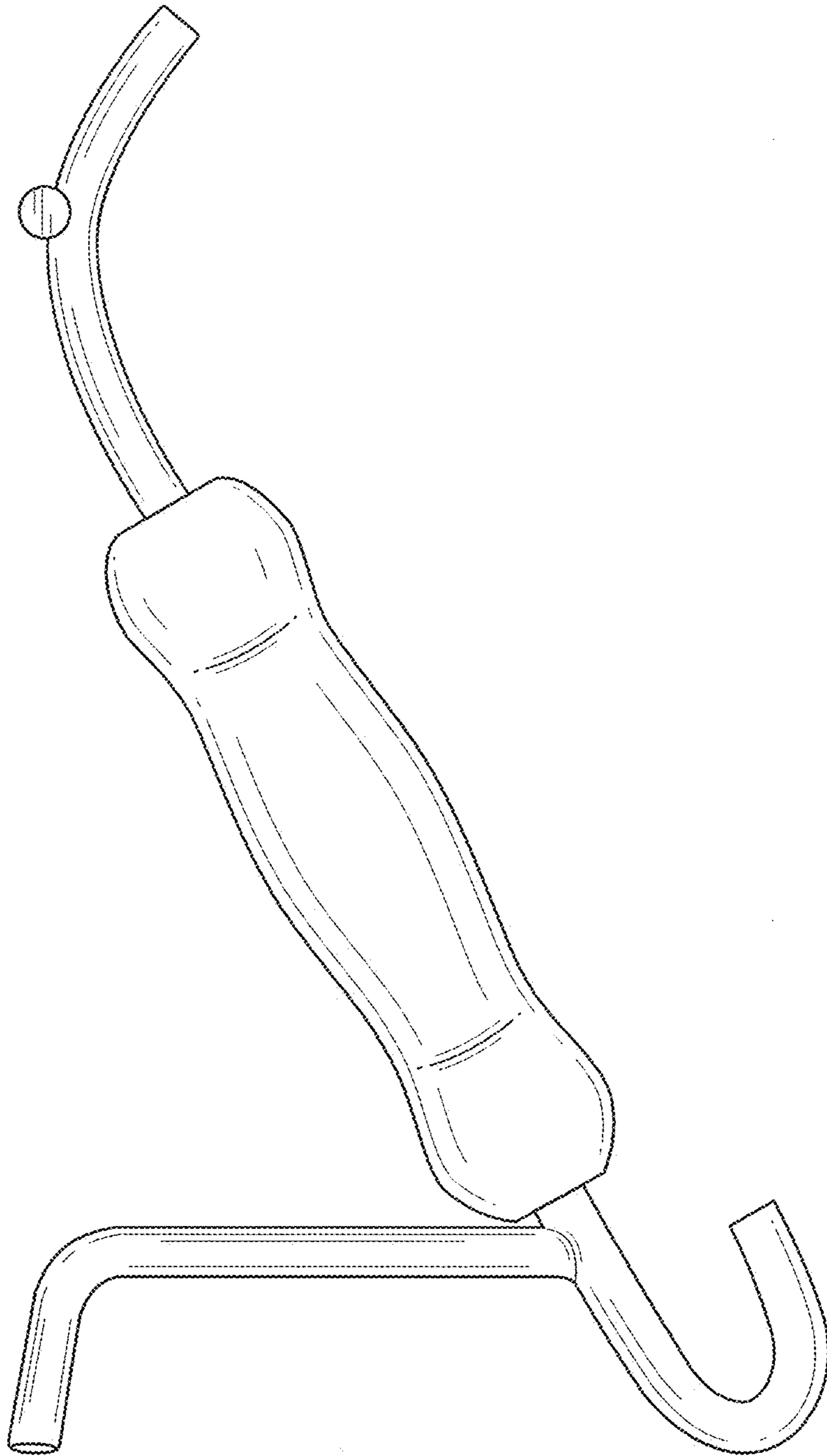

FIG. 4

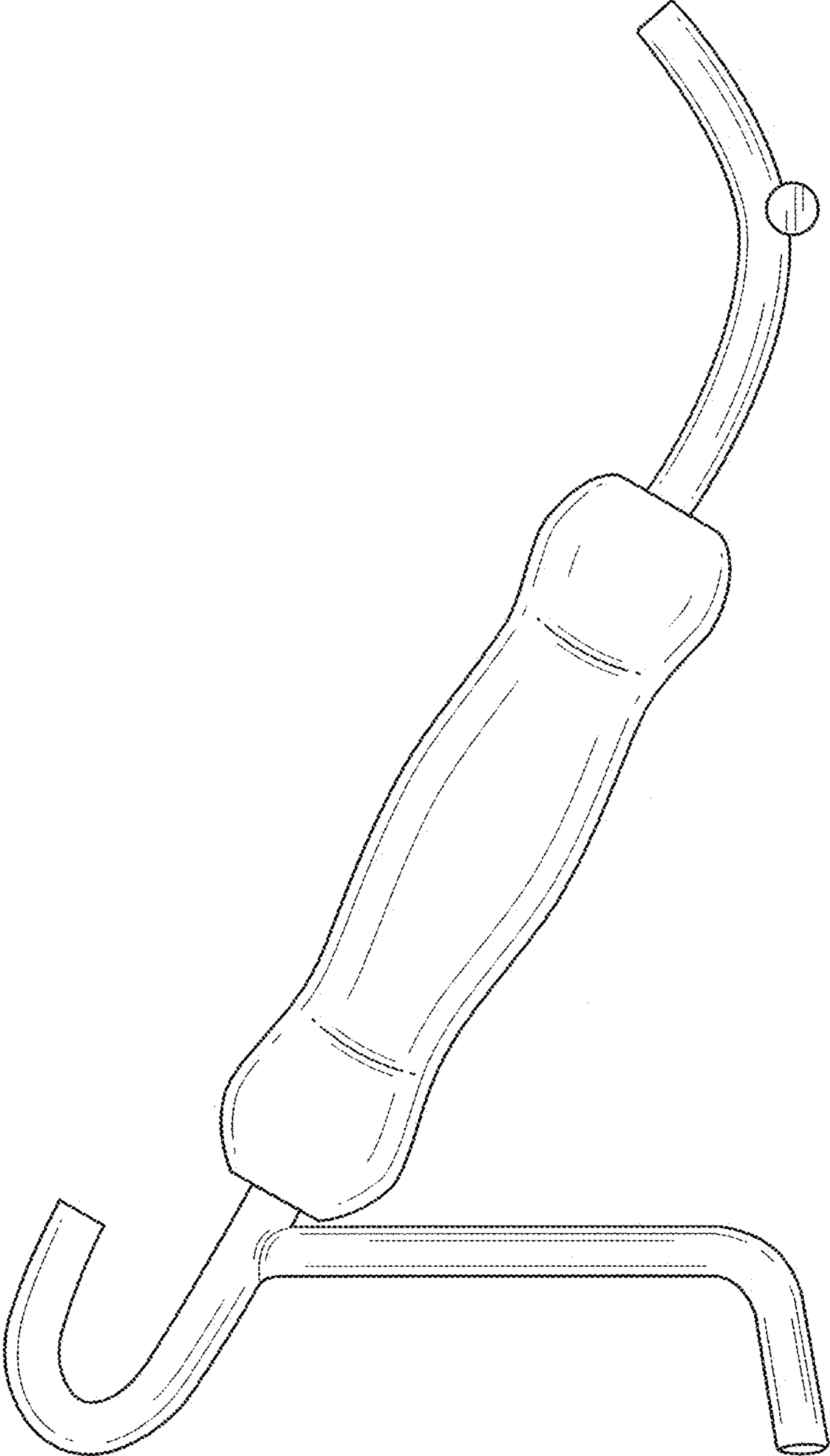

FIG. 5

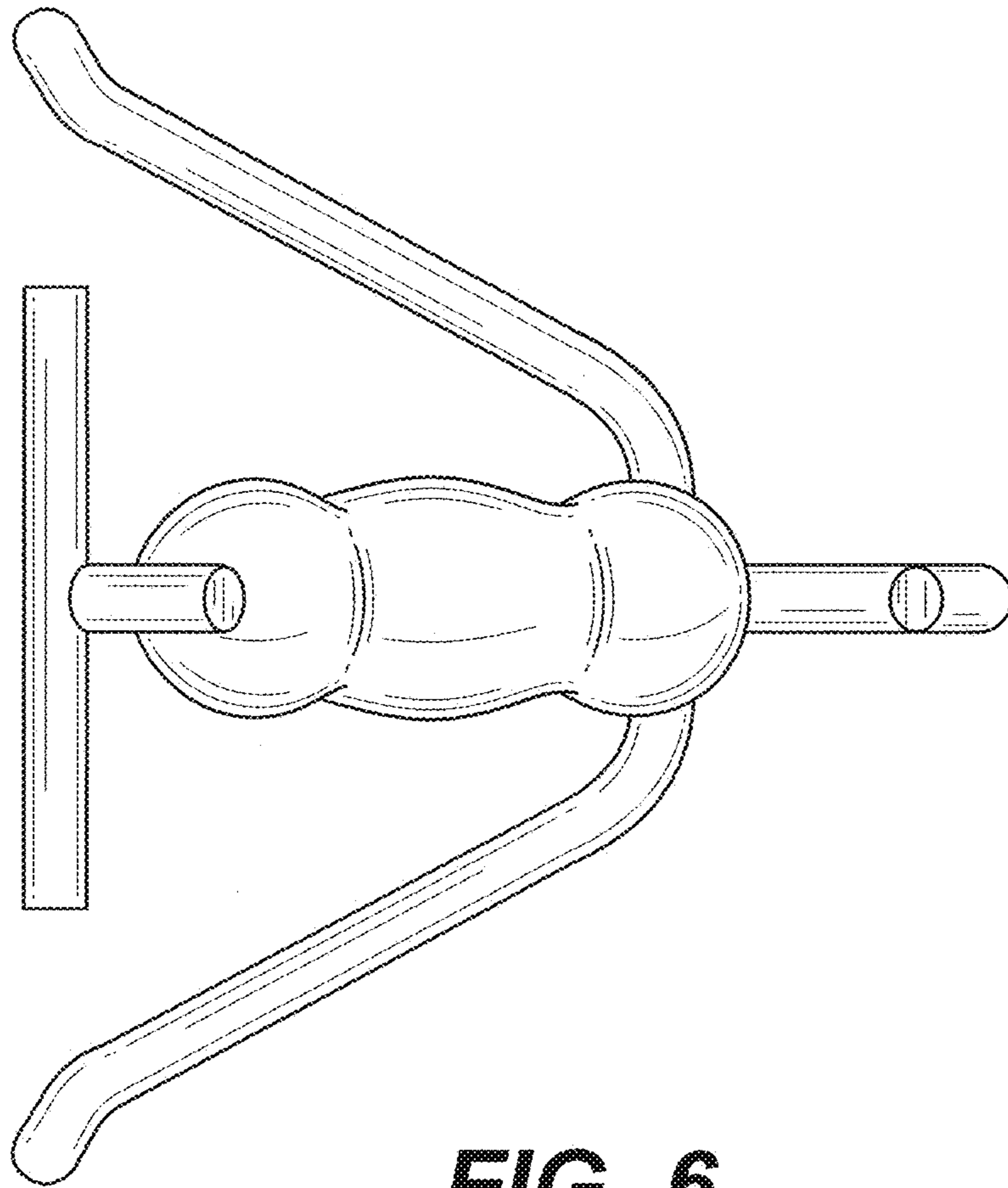

FIG. 6

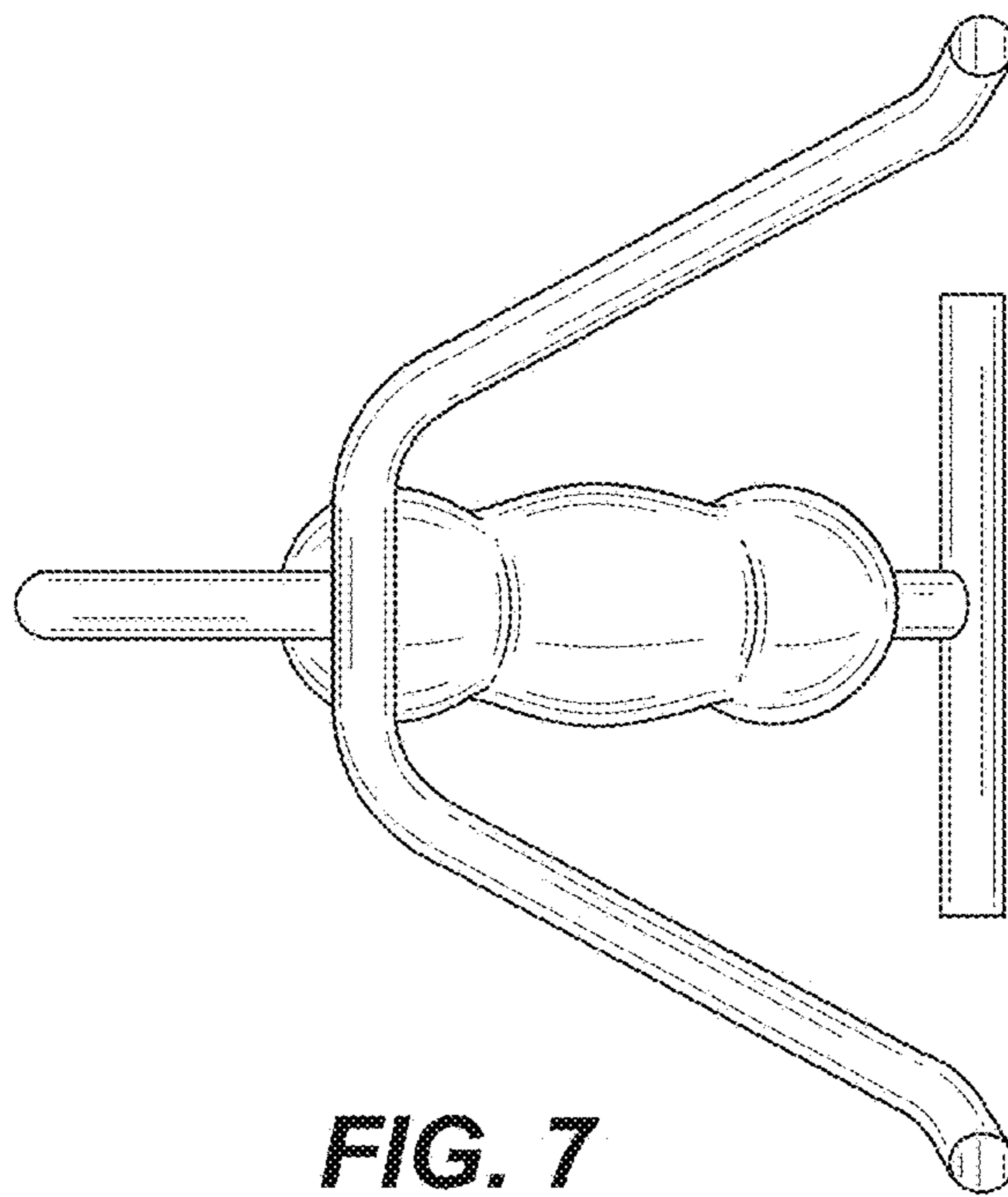

FIG. 7