



US00D785331S

(12) **United States Design Patent**
Yamamoto

(10) **Patent No.:** **US D785,331 S**

(45) **Date of Patent:** **** *May 2, 2017**

(54) **STORAGE CASE**
(71) Applicant: **SHINWA CO., LTD.**, Niigata-Pref. (JP)
(72) Inventor: **Kazunobu Yamamoto**, Niigata-Pref. (JP)
(*) Notice: This patent is subject to a terminal disclaimer.
(**) Term: **14 Years**
(21) Appl. No.: **29/503,438**
(22) Filed: **Sep. 25, 2014**

(30) **Foreign Application Priority Data**
Mar. 26, 2014 (JP) 2014-006402
(51) **LOC (10) Cl.** **03-01**
(52) **U.S. Cl.**
USPC **D3/297**
(58) **Field of Classification Search**
USPC D3/273, 274, 275, 276, 281, 284, 292,
D3/294, 295, 296, 302, 905, 901, 903,
D3/205, 203.1, 279, 282, 242; D27/172,
D27/186, 187, 189, 191; D6/336, 705;
D9/414; D19/72, 86, 92; D34/20
CPC A45C 5/04; A45C 11/16; A61J 1/00; A24F
15/00; A24F 15/005; A24F 15/02; A24F
15/08; A24F 15/20; B65D 27/04
See application file for complete search history.

(56) **References Cited**
U.S. PATENT DOCUMENTS
D188,075 S * 5/1960 Vannice 312/107
D243,900 S * 4/1977 Boyd D3/297
D309,527 S * 7/1990 Singer D24/229
D360,778 S * 8/1995 Apt, III D6/663
D372,378 S * 8/1996 Kruger D6/663

5,680,957 A * 10/1997 Liu A47B 87/0284
220/602
D439,743 S * 4/2001 DeVance D3/297
D439,777 S * 4/2001 Laughton D6/663
D477,154 S * 7/2003 Benn D3/297
D478,208 S * 8/2003 Cassel D3/273
D483,965 S * 12/2003 Cassel D19/75
D499,550 S * 12/2004 Sanders D3/282
D502,812 S * 3/2005 Zimmerman D3/297
D503,042 S * 3/2005 Gutierrez D3/273
D504,772 S * 5/2005 Sanders D3/281
D507,897 S * 8/2005 Juneau D6/663
D535,102 S * 1/2007 Matsuda D3/302
D536,738 S * 2/2007 Smith D19/92
7,222,745 B2 * 5/2007 Gutierrez B65D 11/24
220/645

(Continued)

Primary Examiner — Sandra Snapp
Assistant Examiner — Holly E Thurman
(74) *Attorney, Agent, or Firm* — Prakash Nama; Global IP Services, PLLC

(57) **CLAIM**
The ornamental design for a storage case, shown and described.

DESCRIPTION
FIG. 1 is a front elevational view of storage case showing my new design;
FIG. 2 is a rear elevational view thereof;
FIG. 3 is a left side view thereof;
FIG. 4 is a right side view thereof;
FIG. 5 is a top, plan view thereof;
FIG. 6 is a bottom plan view thereof;
FIG. 7 is a top perspective view thereof;
FIG. 8 is a top perspective view of the storage case, shown in a reduced scale, with a compartment pulled out; and,
FIG. 9 is a bottom perspective view of the storage case.
The broken lines depict portions of the storage case that form no part of the claimed design.

1 Claim, 9 Drawing Sheets

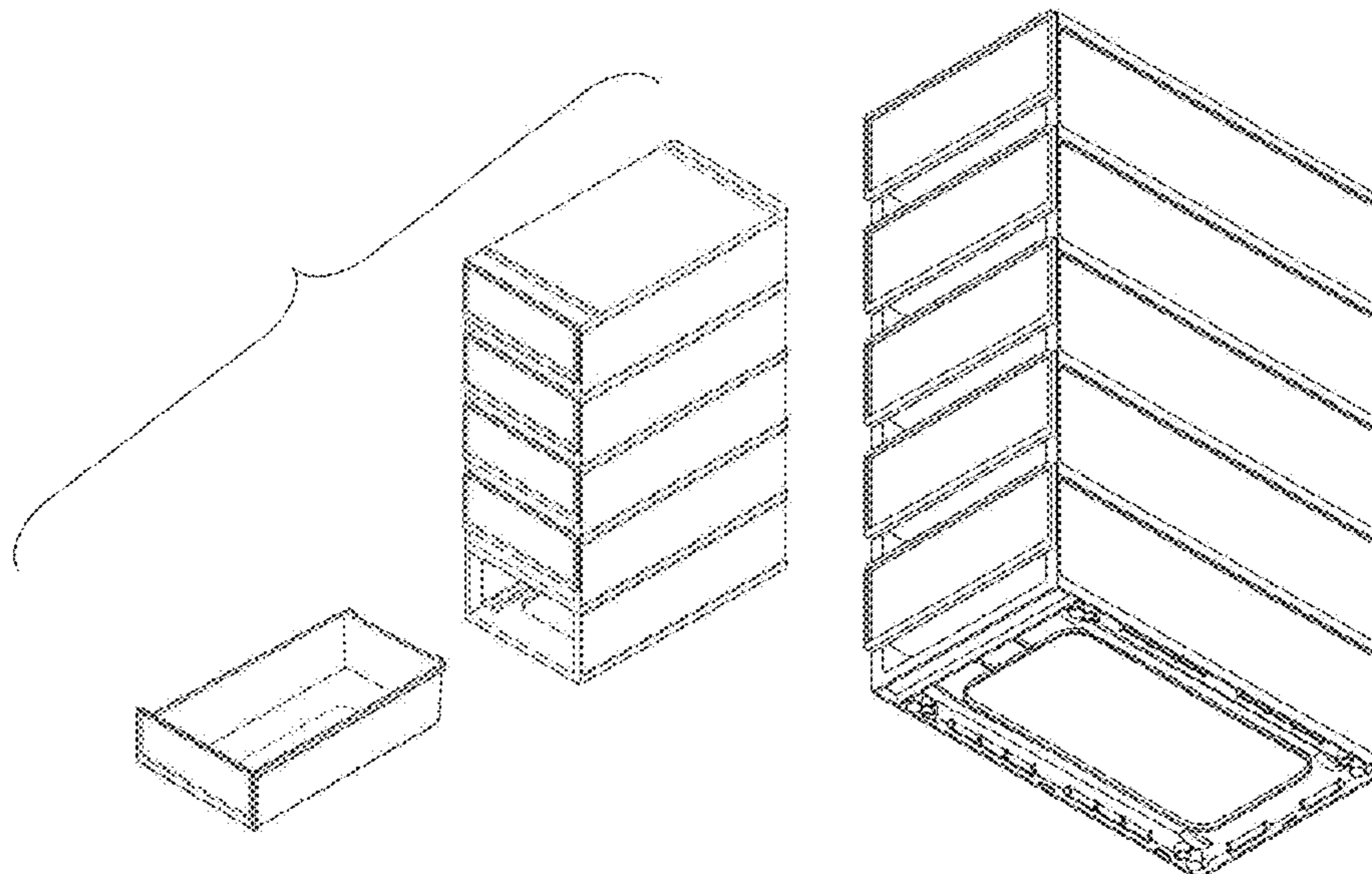

(56)

References Cited

U.S. PATENT DOCUMENTS

D549,408	S *	8/2007	Lee	D32/25
D553,393	S *	10/2007	Cassel	D6/675.1
D580,172	S *	11/2008	Perez	D3/297
D583,172	S *	12/2008	Cassel	D3/297
D597,341	S *	8/2009	Stein	D3/297
D599,589	S *	9/2009	Cassel	D3/297
D601,834	S *	10/2009	Szych	D3/203.1
D634,483	S *	3/2011	Sullivan	D30/108
D634,564	S *	3/2011	Licari	D6/657
D670,111	S *	11/2012	McNamara	D6/705
D671,318	S *	11/2012	Schmidt	D3/297
D708,875	S *	7/2014	McNamara	D6/705
D740,026	S *	10/2015	Yamamoto	D3/297
D740,027	S *	10/2015	Yamamoto	D3/297
D740,563	S *	10/2015	Yamamoto	D3/297
9,353,989	B2 *	5/2016	Furr	F25D 25/025
2002/0092787	A1 *	7/2002	Cheng	B65D 11/1893
					206/459.5
2005/0122008	A1 *	6/2005	Atwood	A47F 11/04
					312/117

* cited by examiner

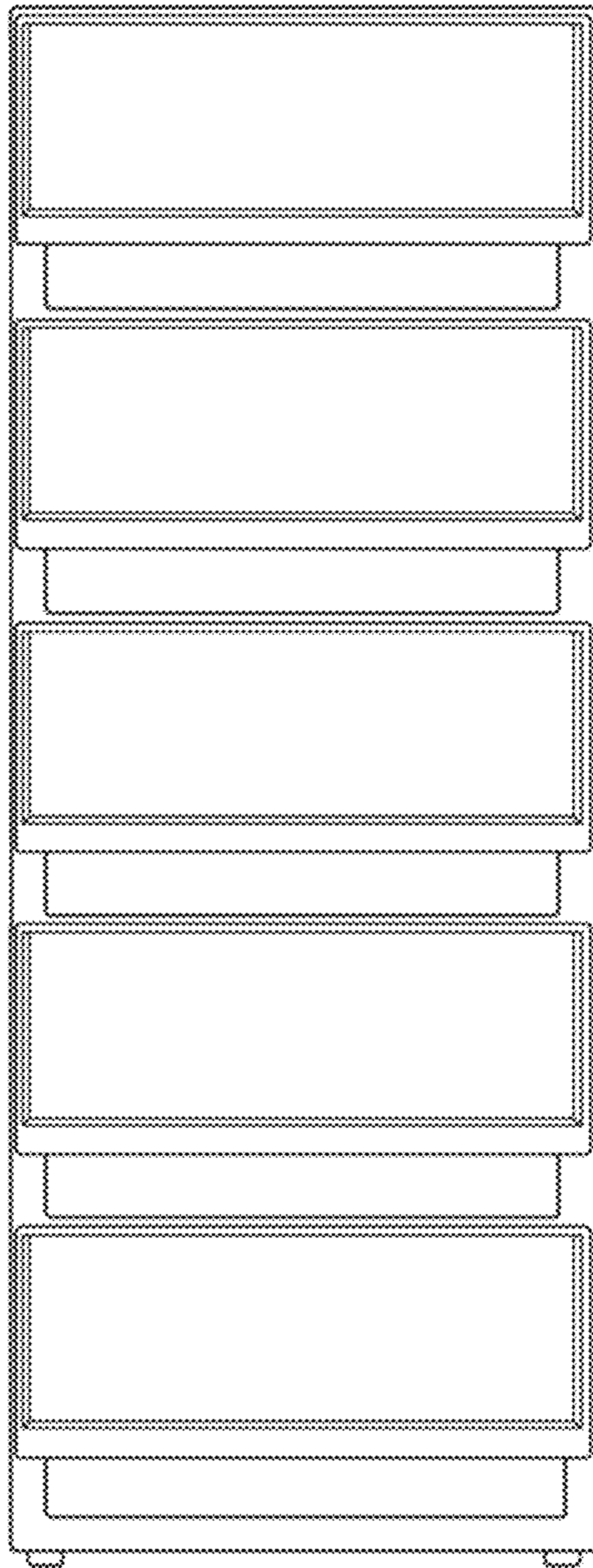

FIG. 1

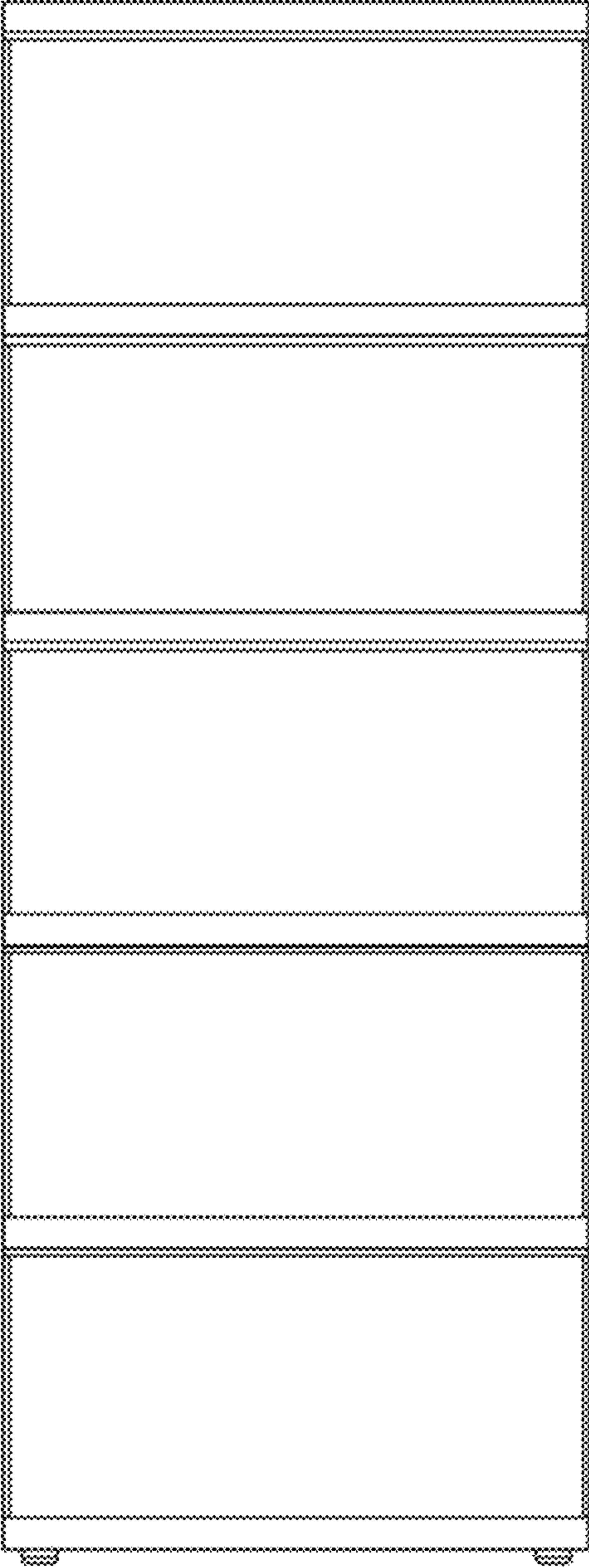

FIG. 2

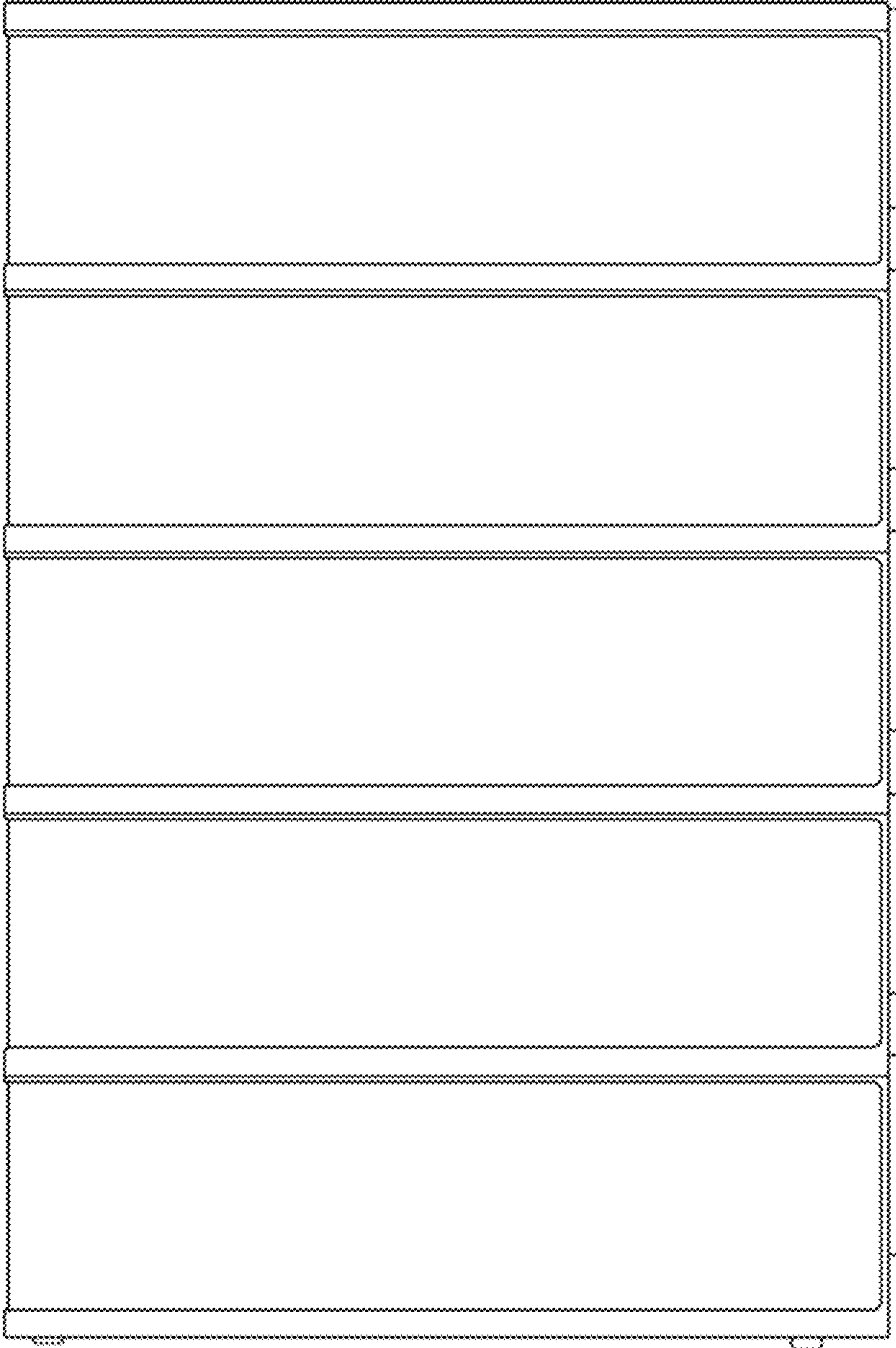

FIG. 3



FIG. 4

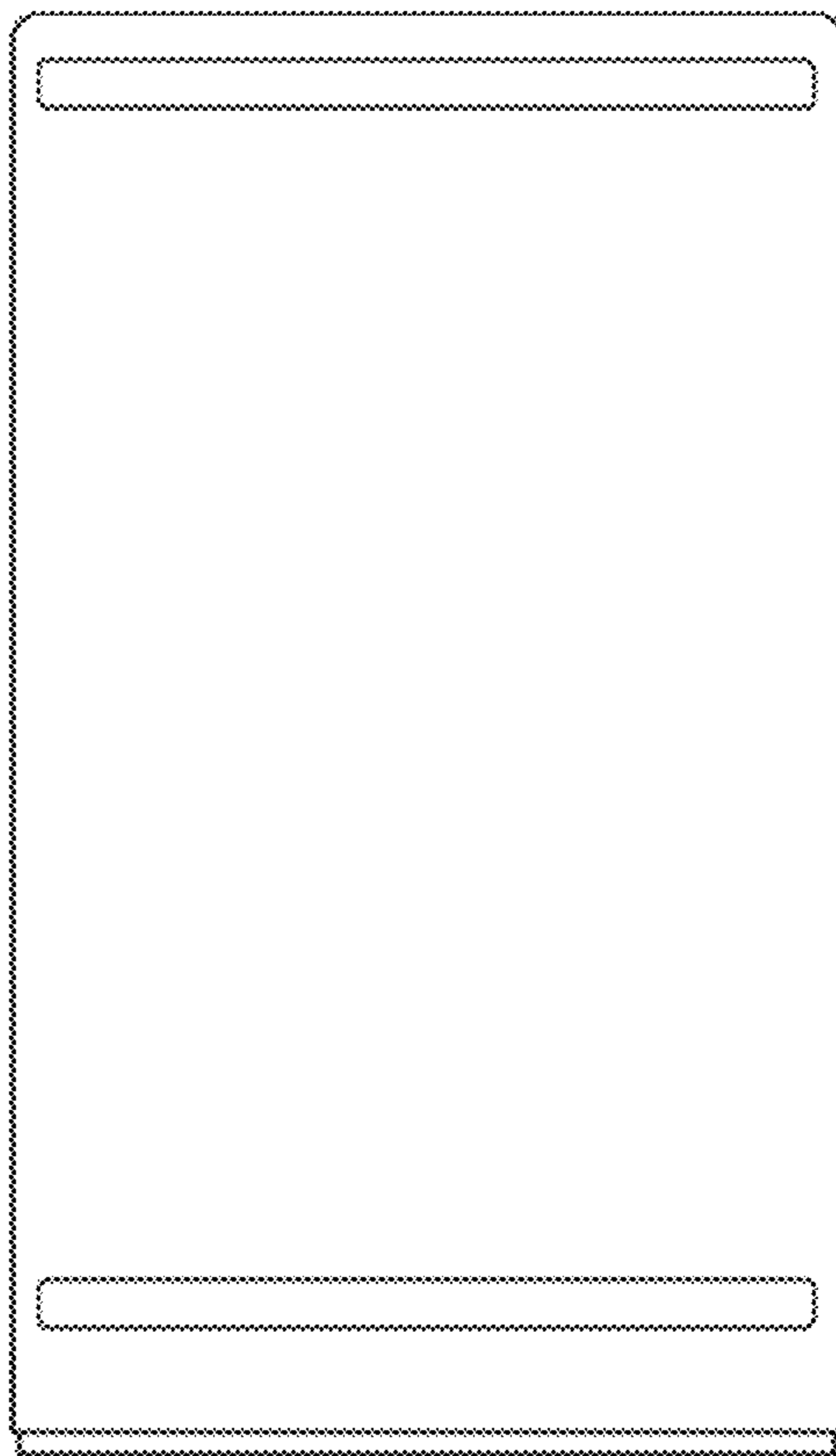

FIG. 5

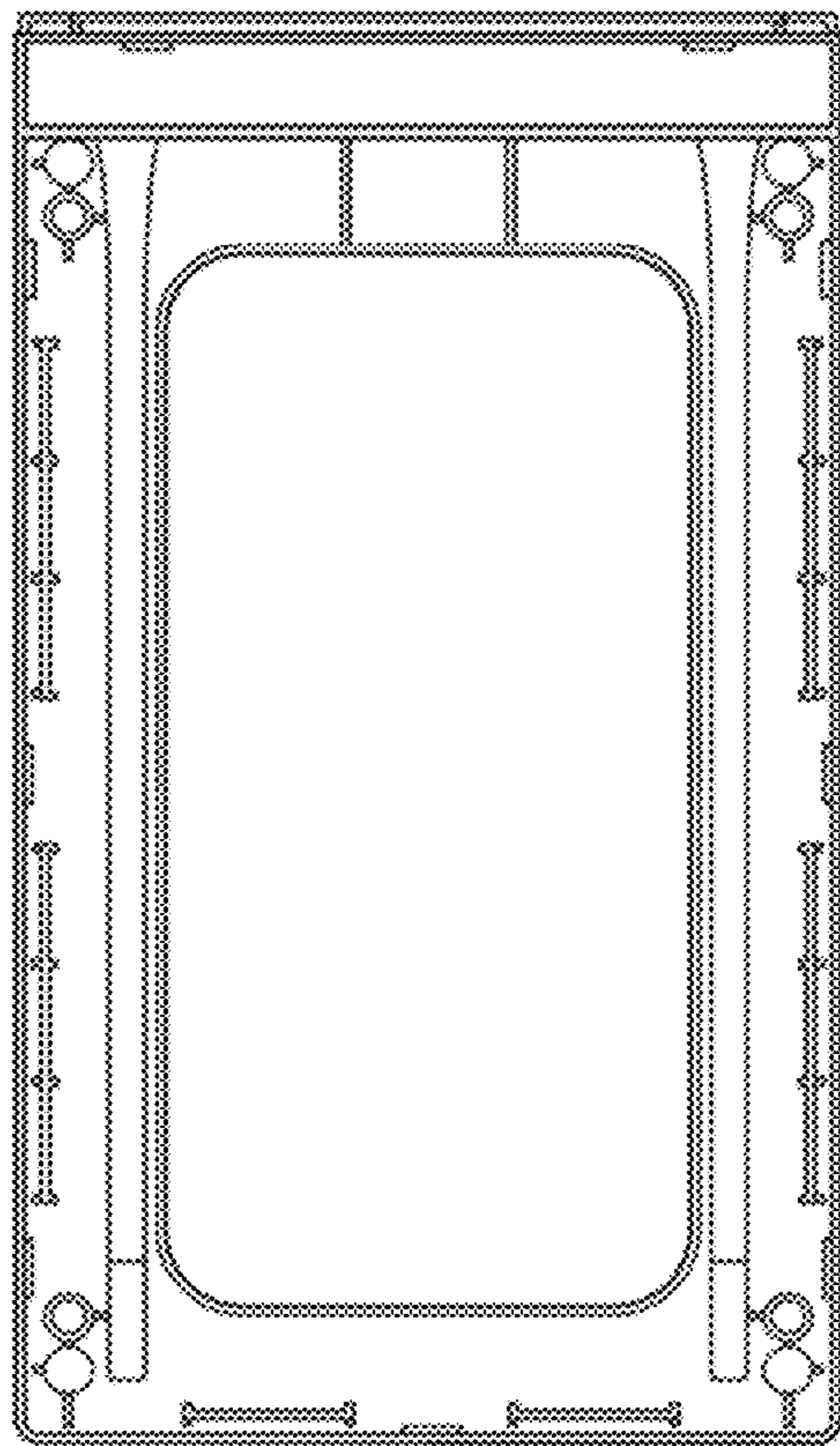

FIG. 6

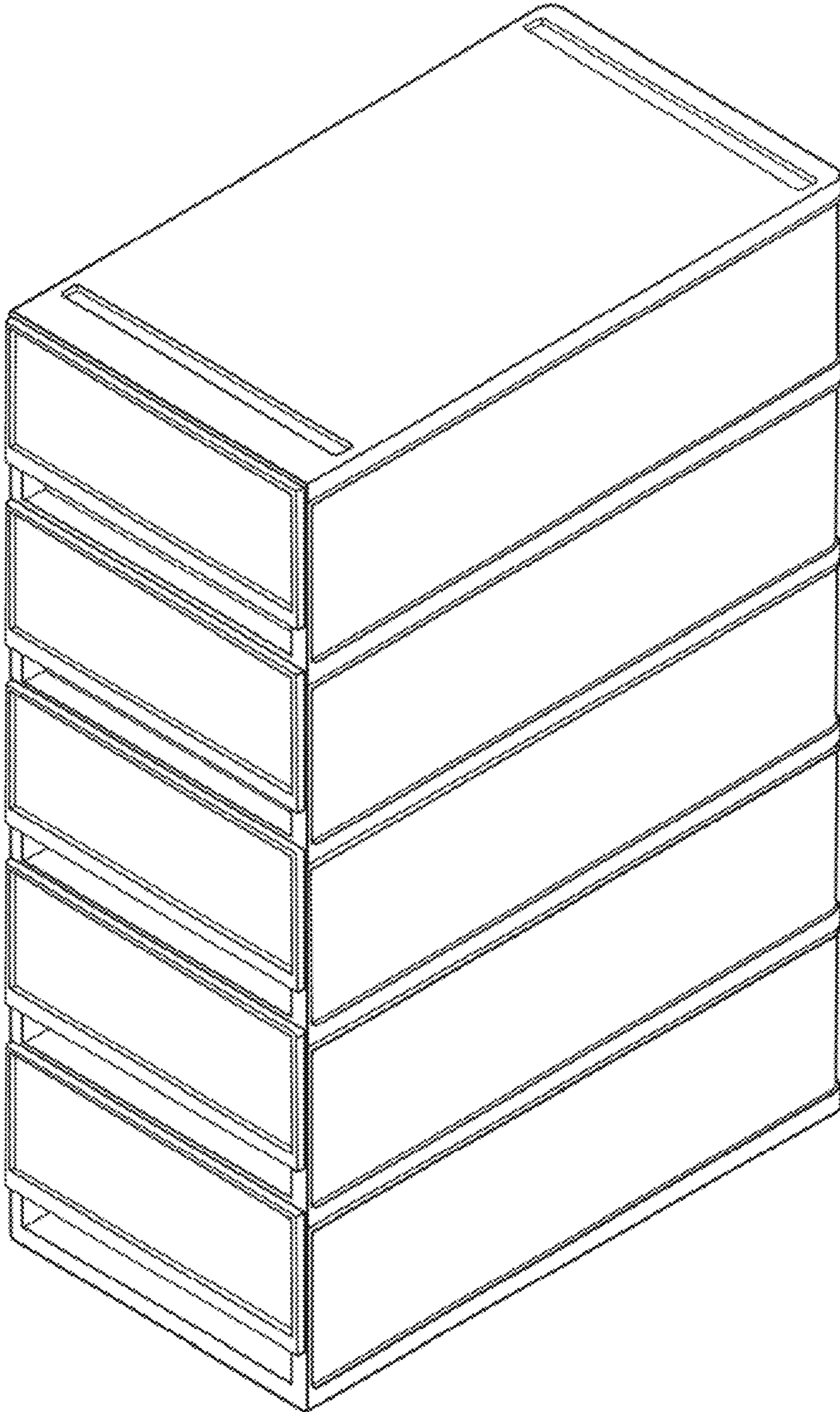

FIG. 7

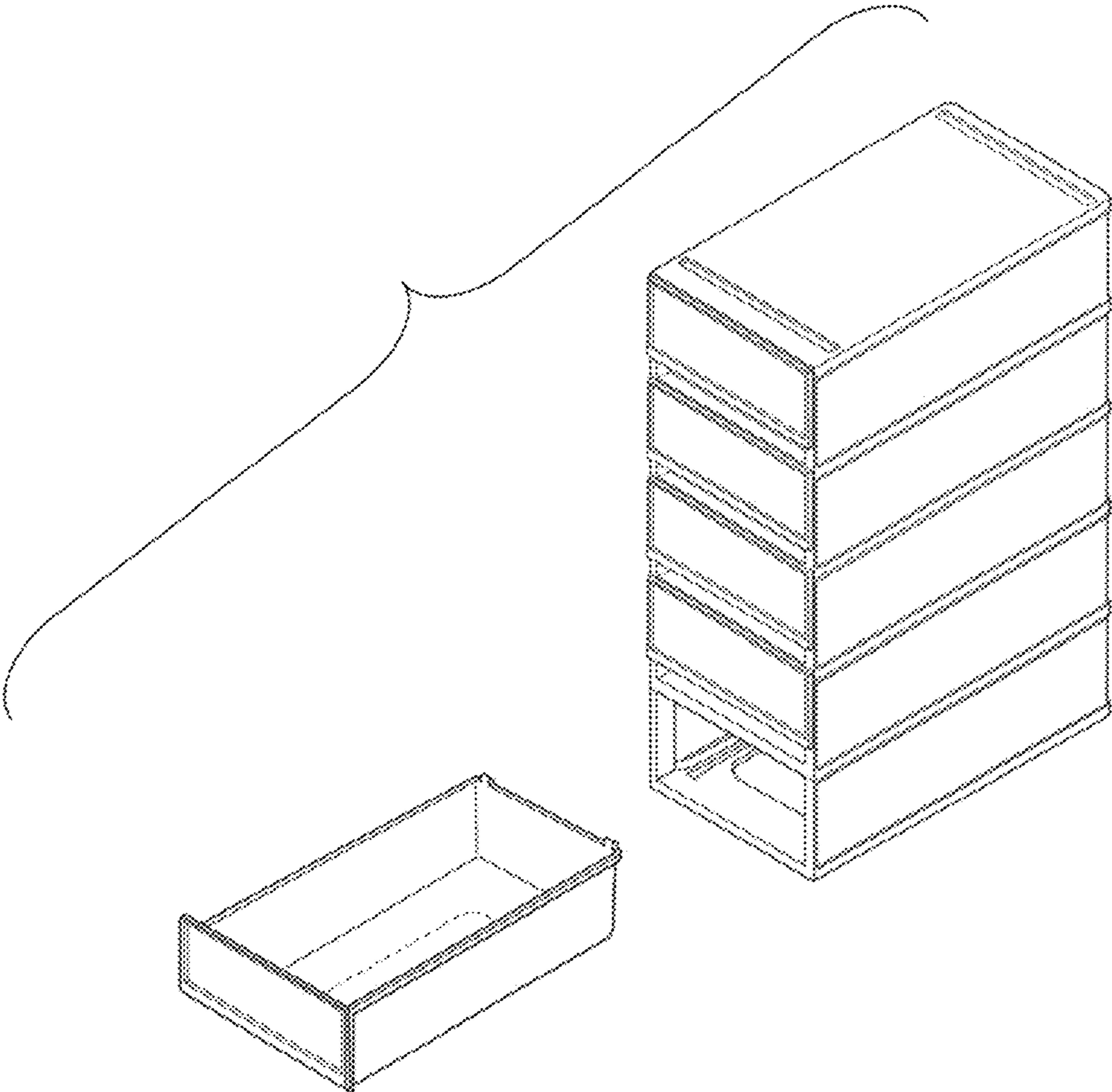

FIG. 8

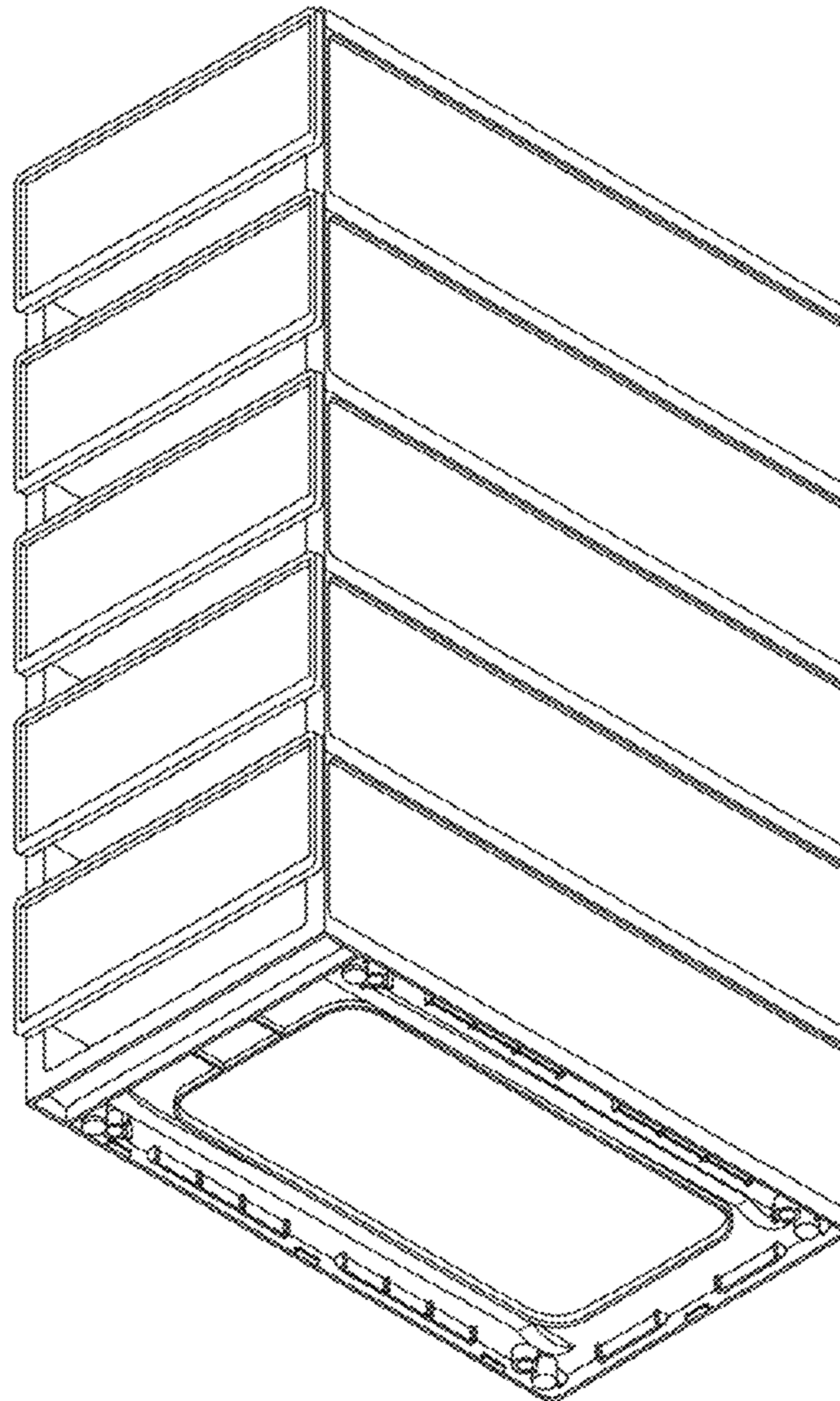

FIG. 9