



US00D785265S

(12) **United States Design Patent**
Palladino et al.

(10) **Patent No.:** **US D785,265 S**
(45) **Date of Patent:** **** Apr. 25, 2017**

- (54) **FLOOR CLEANER**
- (71) Applicant: **SharkNinja Operating LLC**, Newton, MA (US)
- (72) Inventors: **Gary Palladino**, Somerville, MA (US); **Dmitry Layevsky**, Newton, MA (US)
- (73) Assignee: **SharkNinja Operating LLC**, Newton, MA (US)

8,671,510 B2 * 3/2014 Han A47L 5/225
15/329
D704,399 S * 5/2014 Crawley D32/17
D711,058 S * 8/2014 Crawley D32/45
(Continued)

FOREIGN PATENT DOCUMENTS

CN 301826896 * 2/2012
CN 302387310 * 4/2013
(Continued)

(**) Term: **14 Years**

OTHER PUBLICATIONS

- (21) Appl. No.: **29/518,396**
- (22) Filed: **Feb. 23, 2015**
- (51) **LOC (10) Cl.** **04-01**
- (52) **U.S. Cl.**
USPC **D32/45; D32/50**
- (58) **Field of Classification Search**
USPC D32/38-40, 45, 50-52, 71-72
CPC A47L 13/22-13/26; A47L 13/254; A47L
9/00
See application file for complete search history.

Amazon.com—Bissell Steam Mop Hard-Floor Cleaner, online, review date 11/2/2209, http://www.amazon.com/Bissell-Steam-Hard-Floor-Cleaner-1867-7/dp/B000RPVHZU/ref=sr_1_57?s=vacuums&ie=UTF8&qid=1459206024&sr=1-57&keywords=shark+steam+mop, [site visited Mar. 28, 2016 7:02:03 PM].*

(Continued)

Primary Examiner — John Windmuller
Assistant Examiner — John R Yeh
(74) *Attorney, Agent, or Firm* — Ntellect Law, P.C.

(57) **CLAIM**

The ornamental design for a floor cleaner, as illustrated and described.

(56) **References Cited**

U.S. PATENT DOCUMENTS

- D458,427 S * 6/2002 Kunkler D32/45
- D497,699 S * 10/2004 Chi-Hsiang D32/45
- D597,717 S * 8/2009 Rosenzweig D32/45
- D656,283 S * 3/2012 Lavy D32/45
- D657,518 S * 4/2012 McGee D32/45
- D658,835 S * 5/2012 Houghton D32/45
- D661,035 S * 5/2012 McGee D32/45
- D673,337 S * 12/2012 Chow D32/45
- 8,425,137 B1 * 4/2013 Sampaio A47L 13/22
401/139
- D685,557 S * 7/2013 Rosenzweig D32/45
- D685,558 S * 7/2013 deBlois D32/17
- D685,967 S * 7/2013 Houghton D32/45
- 8,534,301 B2 * 9/2013 Nottingham A47L 13/22
134/105

DESCRIPTION

FIG. 1 is a perspective view of a floor cleaner in accordance with our design;
FIG. 2 is a front view thereof;
FIG. 3 is a rear view thereof;
FIG. 4 is a right side view thereof;
FIG. 5 is a left side view thereof;
FIG. 6 is a top view thereof; and,
FIG. 7 is a bottom view thereof.
The broken lines in the figures represent features of the floor cleaner which form no part of the claimed design.

1 Claim, 6 Drawing Sheets

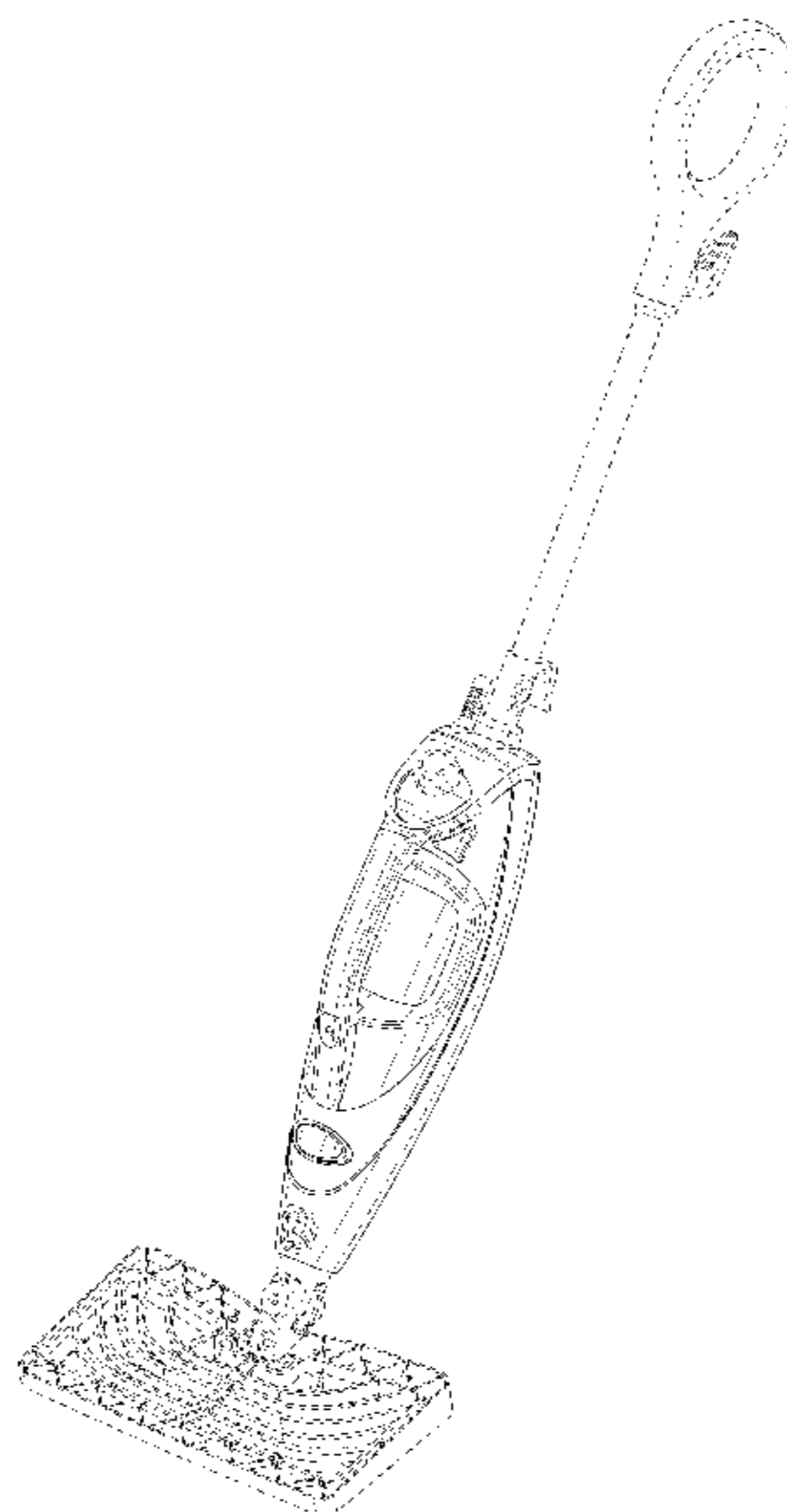

(56)

References Cited

U.S. PATENT DOCUMENTS

2004/0071490 A1* 4/2004 Vosbikian A47L 13/12
401/49
2007/0136984 A1* 6/2007 Hsu A47L 5/225
15/339
2009/0320231 A1* 12/2009 Rosenzweig A47L 13/22
15/339
2010/0050367 A1* 3/2010 Tsai A47L 13/225
15/320
2013/0232719 A1* 9/2013 Luedke A47L 13/225
15/320
2015/0013098 A1* 1/2015 Vrdoljak A47L 13/225
15/320
2015/0183108 A1* 7/2015 Thorne B25G 1/06
15/144.1

FOREIGN PATENT DOCUMENTS

CN 302738945 * 2/2014
JP 1358258 S 5/2009

OTHER PUBLICATIONS

Amazon.com—Shark 2-in-1 Blast & Scrub Steam Pocket Mop,
online, review date Dec. 24, 2015, http://www.amazon.com/Shark-Blast-Scrub-Steam-Pocket/dp/B016BJVAXY/ref=cm_cr_ar_p_d_product_top?ie=UTF8, site visited [Mar. 28, 2016 6:45:55 PM].*
Examiner Notice from Japanese Design No. 2015-013020 dated
Nov. 24, 2015.

* cited by examiner

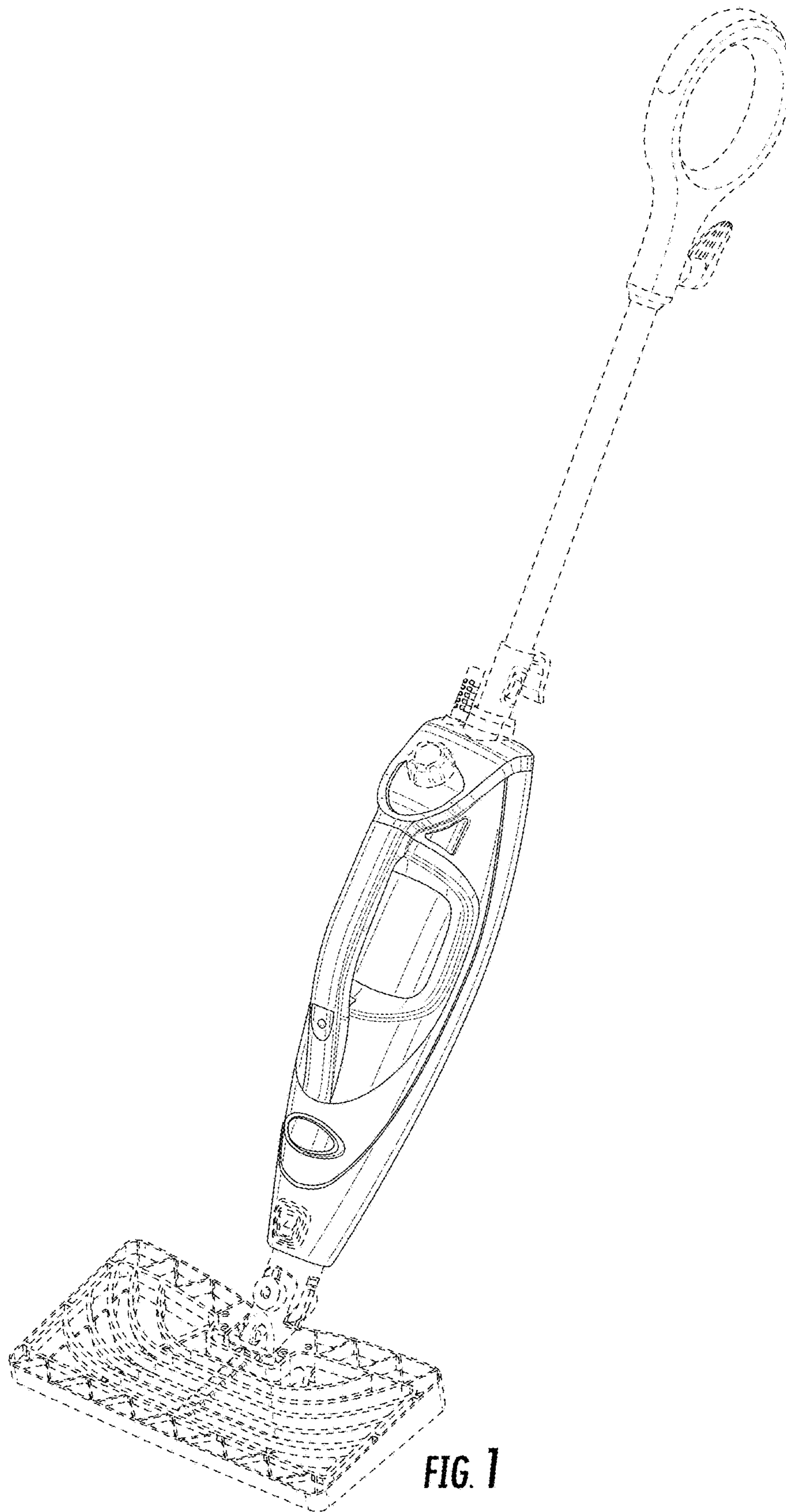

FIG. 1

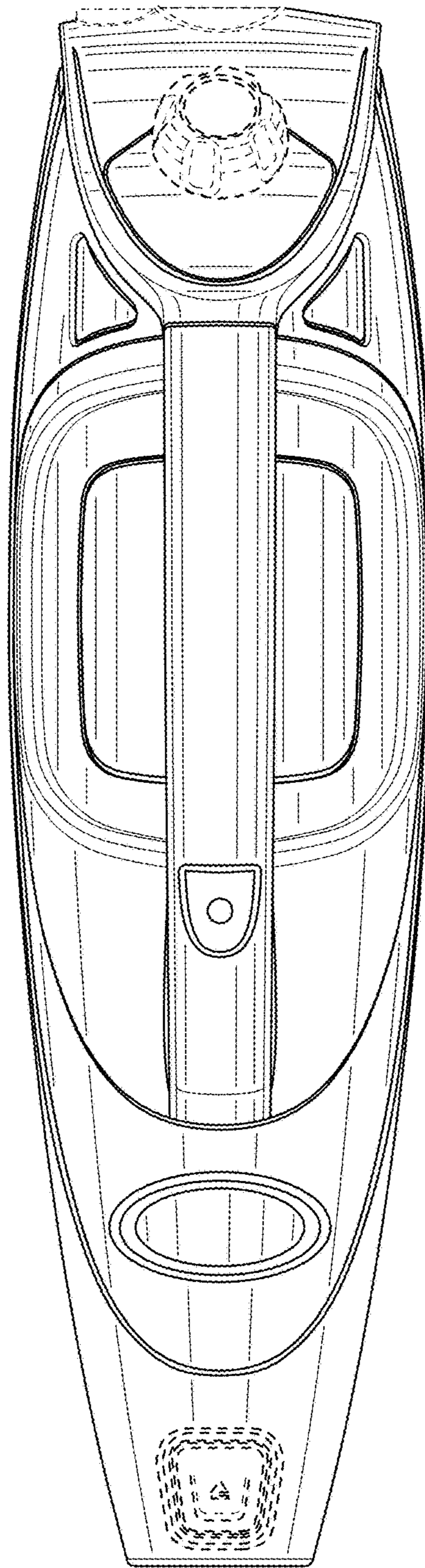

FIG. 2

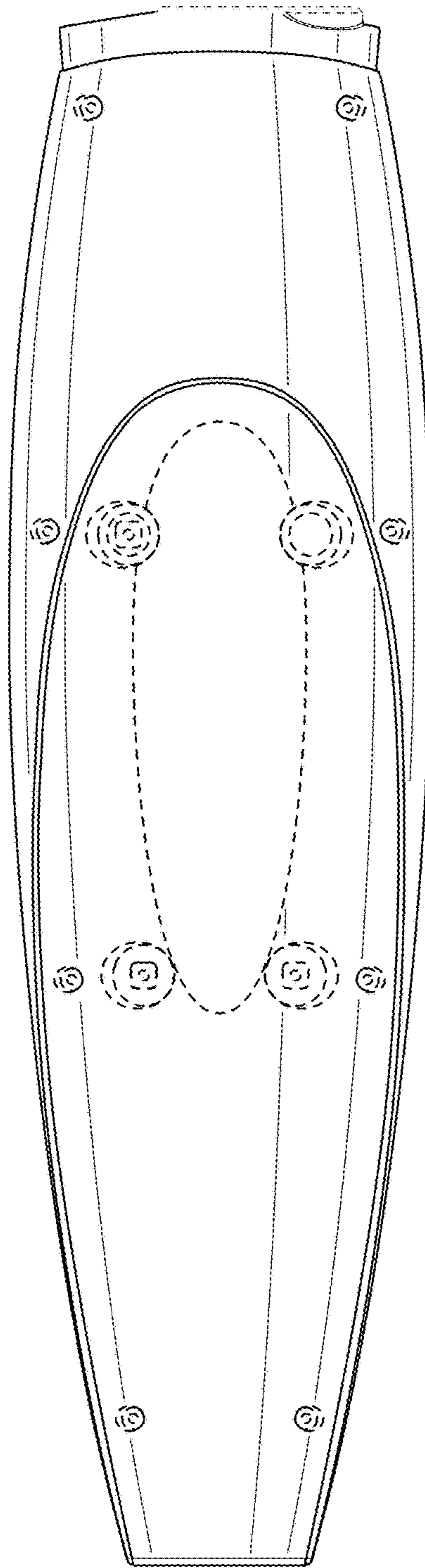

FIG. 3

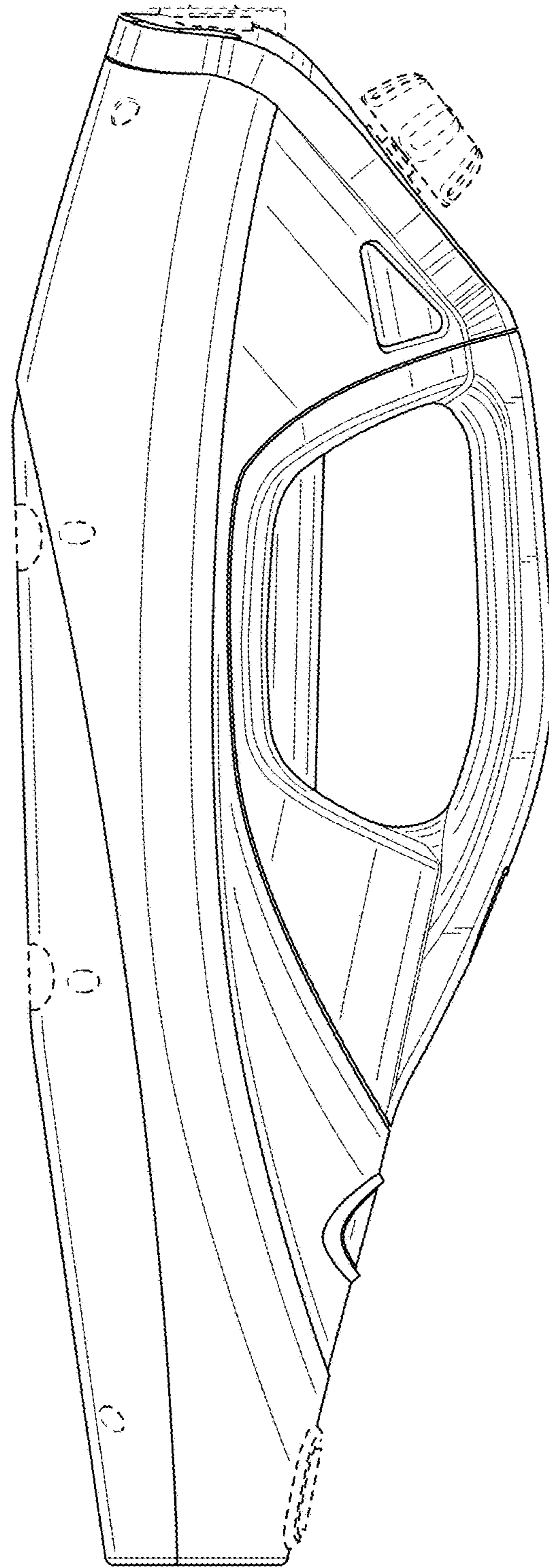

FIG. 4

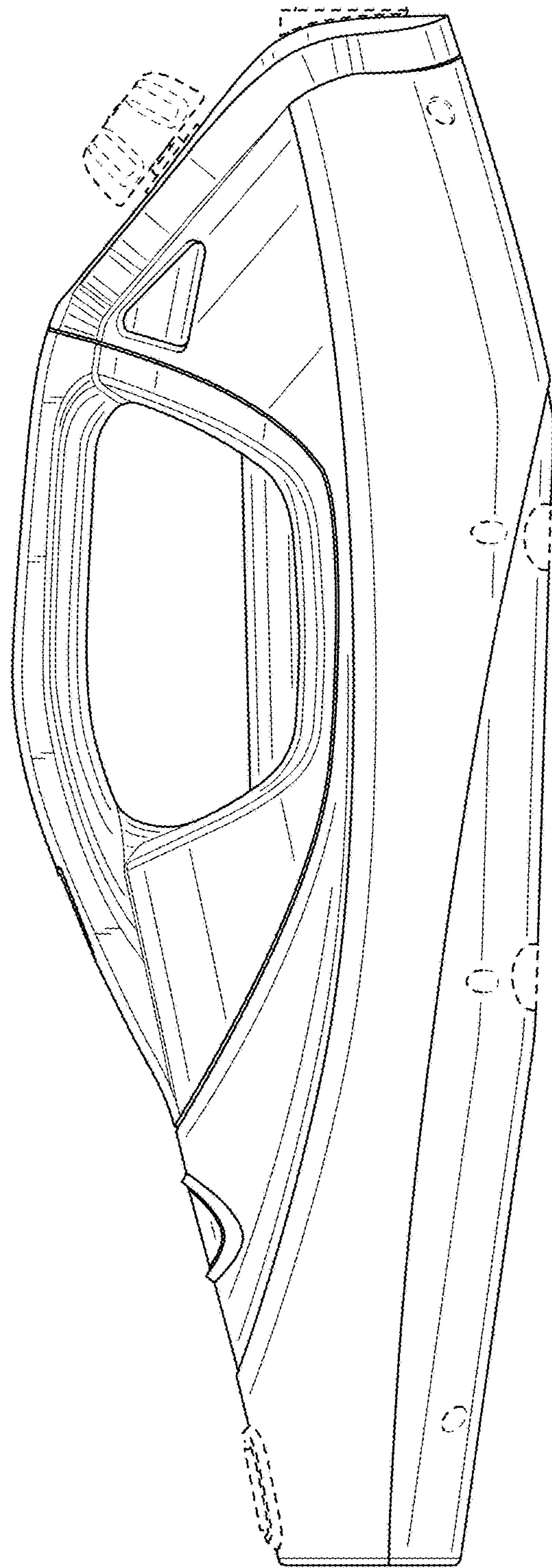

FIG. 5

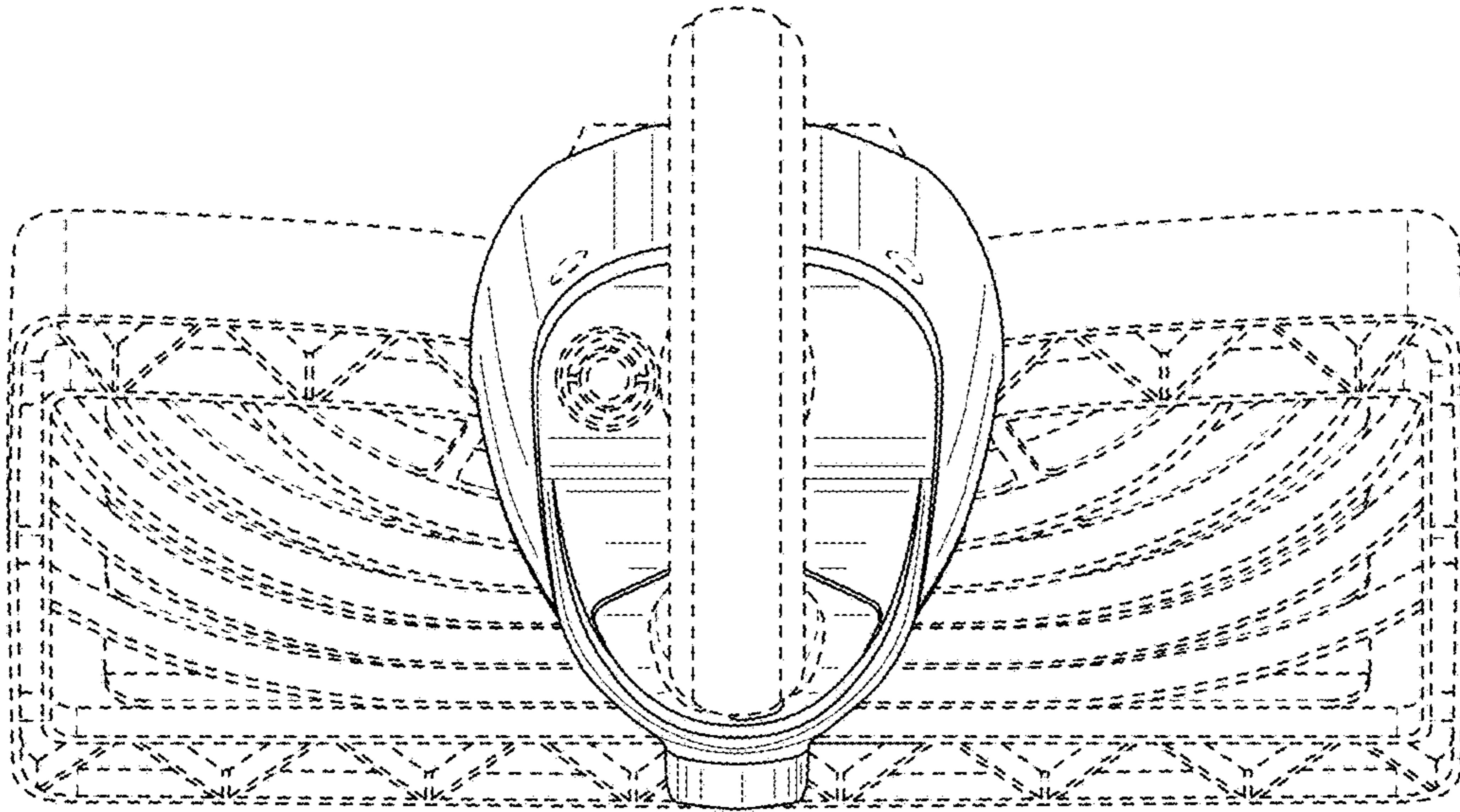

FIG. 6

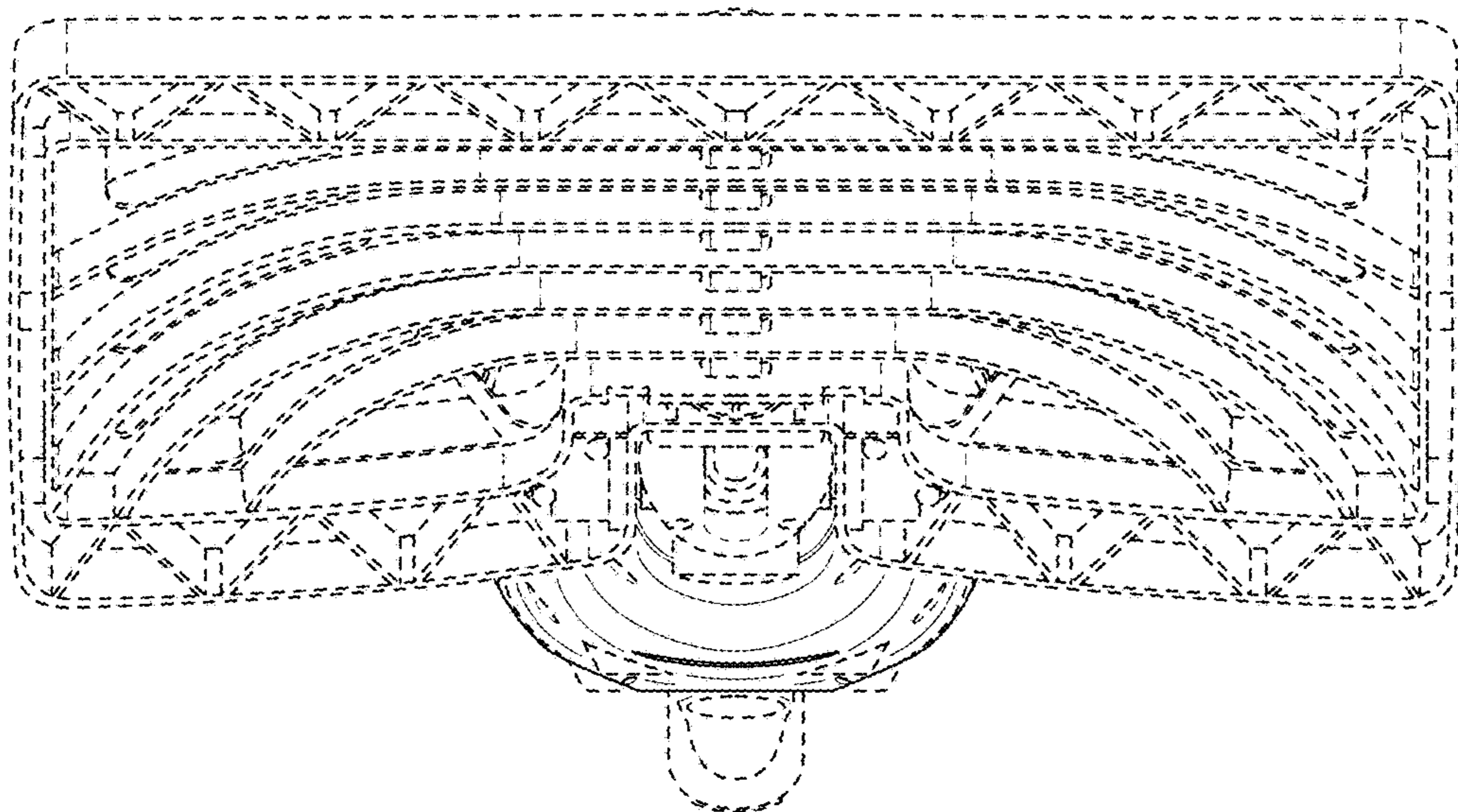

FIG. 7