



US00D785253S

(12) **United States Design Patent**
Thrasher

(10) **Patent No.:** **US D785,253 S**
(45) **Date of Patent:** **** Apr. 25, 2017**

(54) **CYLINDRICAL DISHWASHER WITH DOME TOP**

(71) Applicant: **Carl Thrasher**, Springfield, VA (US)

(72) Inventor: **Carl Thrasher**, Springfield, VA (US)

(**) Term: **15 Years**

(21) Appl. No.: **29/537,901**

(22) Filed: **Aug. 30, 2015**

(51) **LOC (10) Cl.** **15-05**

(52) **U.S. Cl.**
USPC **D32/2**

(58) **Field of Classification Search**
USPC D32/1-3, 25-27; D23/213, 218, 221
CPC A47L 15/0076; A47L 15/0078; A47L 15/0081

See application file for complete search history.

(56) **References Cited**

U.S. PATENT DOCUMENTS

- 598,432 A * 2/1898 McClausland A47L 15/08
134/190
- D119,849 S * 4/1940 Nielson D32/2
- 2,197,382 A * 4/1940 Murphy A47L 15/4418
134/175
- D126,848 S * 4/1941 Cox D32/2
- 2,241,144 A * 5/1941 Lattin B08B 9/28
134/170
- D129,304 S * 9/1941 Weeks D32/2
- 2,286,203 A * 6/1942 Fox A47L 15/23
239/227
- D135,250 S * 3/1943 Palmieri D32/2
- 2,395,747 A * 2/1946 Loeb A47L 15/06
134/182
- 2,425,812 A * 8/1947 Krebs A47L 15/0089
134/197

- D182,330 S * 3/1958 Corbett D32/2
- D182,402 S * 4/1958 Corbett D32/2
- D186,241 S * 9/1959 Otto D32/2
- 4,296,768 A * 10/1981 Saucedo A47L 15/0089
134/115 R
- 4,368,747 A * 1/1983 Taylor A47L 15/32
134/138

* cited by examiner

Primary Examiner — Michael A. Pratt
Assistant Examiner — Michelle E Wilson
(74) *Attorney, Agent, or Firm* — Steven Critzer

(57) **CLAIM**

The ornamental design for a cylindrical dishwasher with dome top, as shown and described.

DESCRIPTION

FIG. 1 is a perspective view of an apparatus embodying the design;
 FIG. 2 is a front view of an apparatus embodying the design;
 FIG. 3 is a back view of an apparatus embodying the design;
 FIG. 4 is a left-hand side view of an apparatus embodying the design;
 FIG. 5 is a right-hand side view of an apparatus embodying the design;
 FIG. 6 is a top view of an apparatus embodying the design;
 FIG. 7 is a bottom view of an apparatus embodying the design; and,
 FIG. 8 is a perspective view of an apparatus embodying the design. The broken-line illustration in FIG. 8 is not a part of the design sought to be patented.
 The broken lines showing the dishes and utensils inside the cylindrical dishwasher are included for the purpose of illustrating environment and form no part of the claimed design.

1 Claim, 5 Drawing Sheets

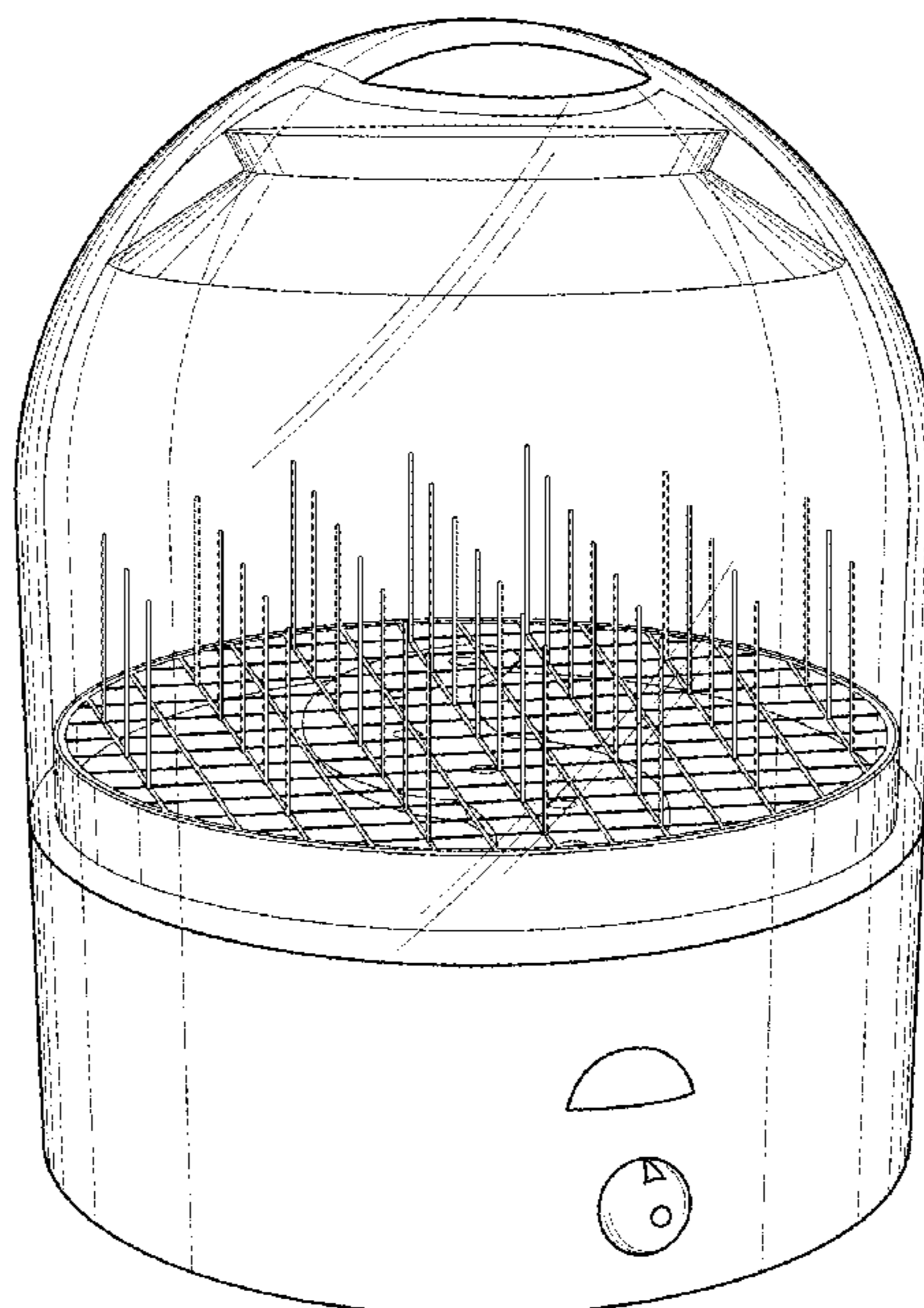

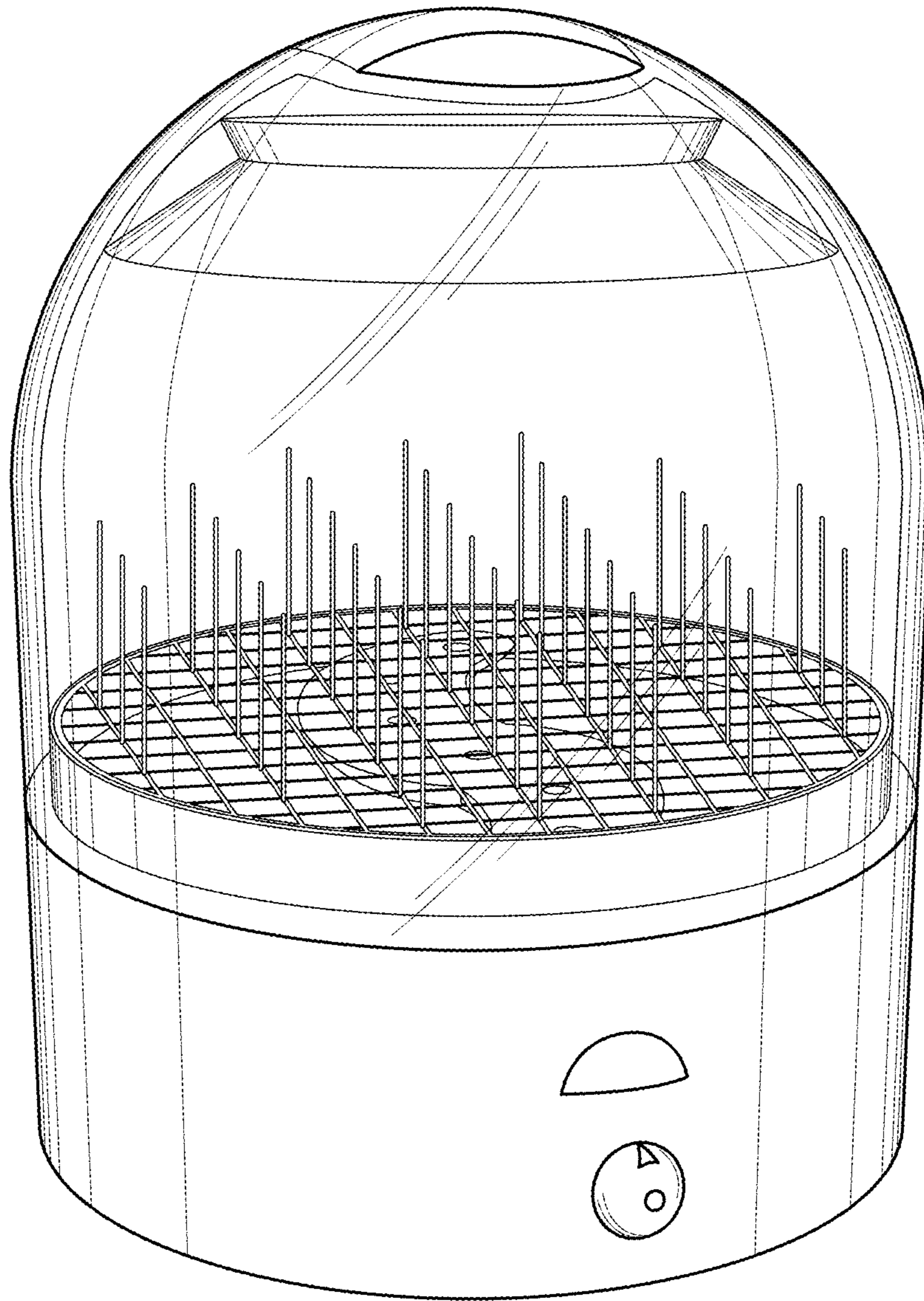

FIG. 1

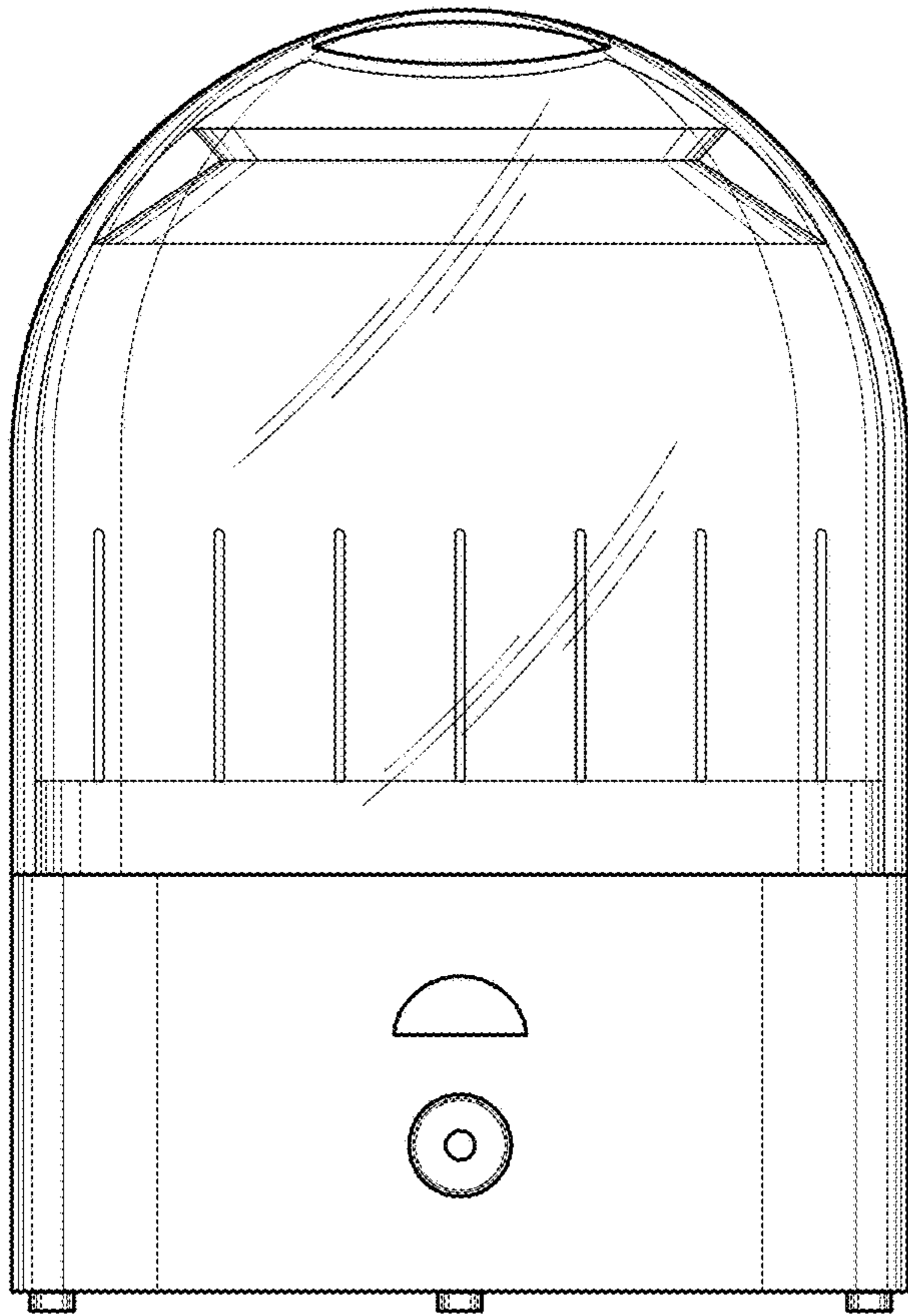

FIG. 2

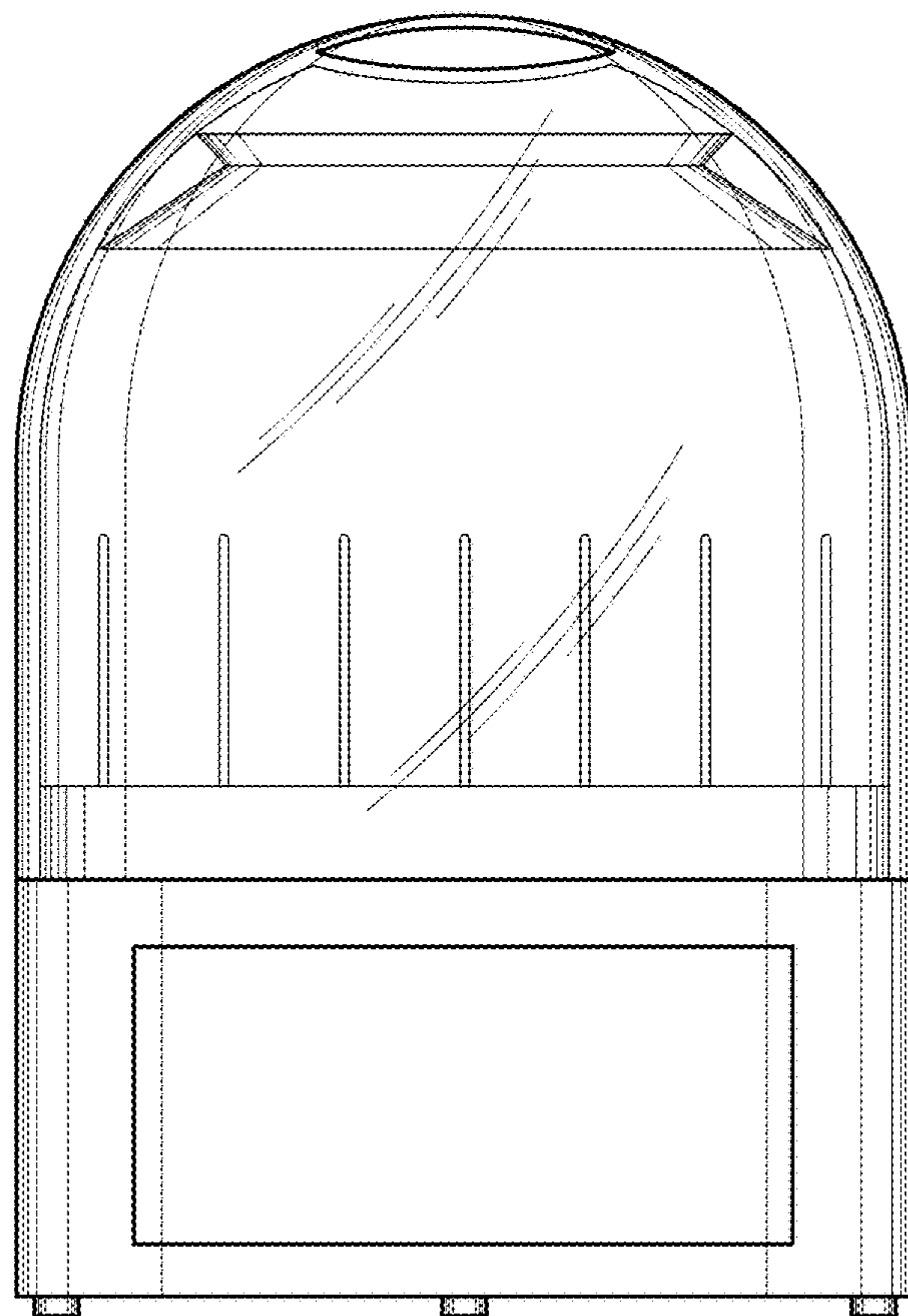

FIG. 3

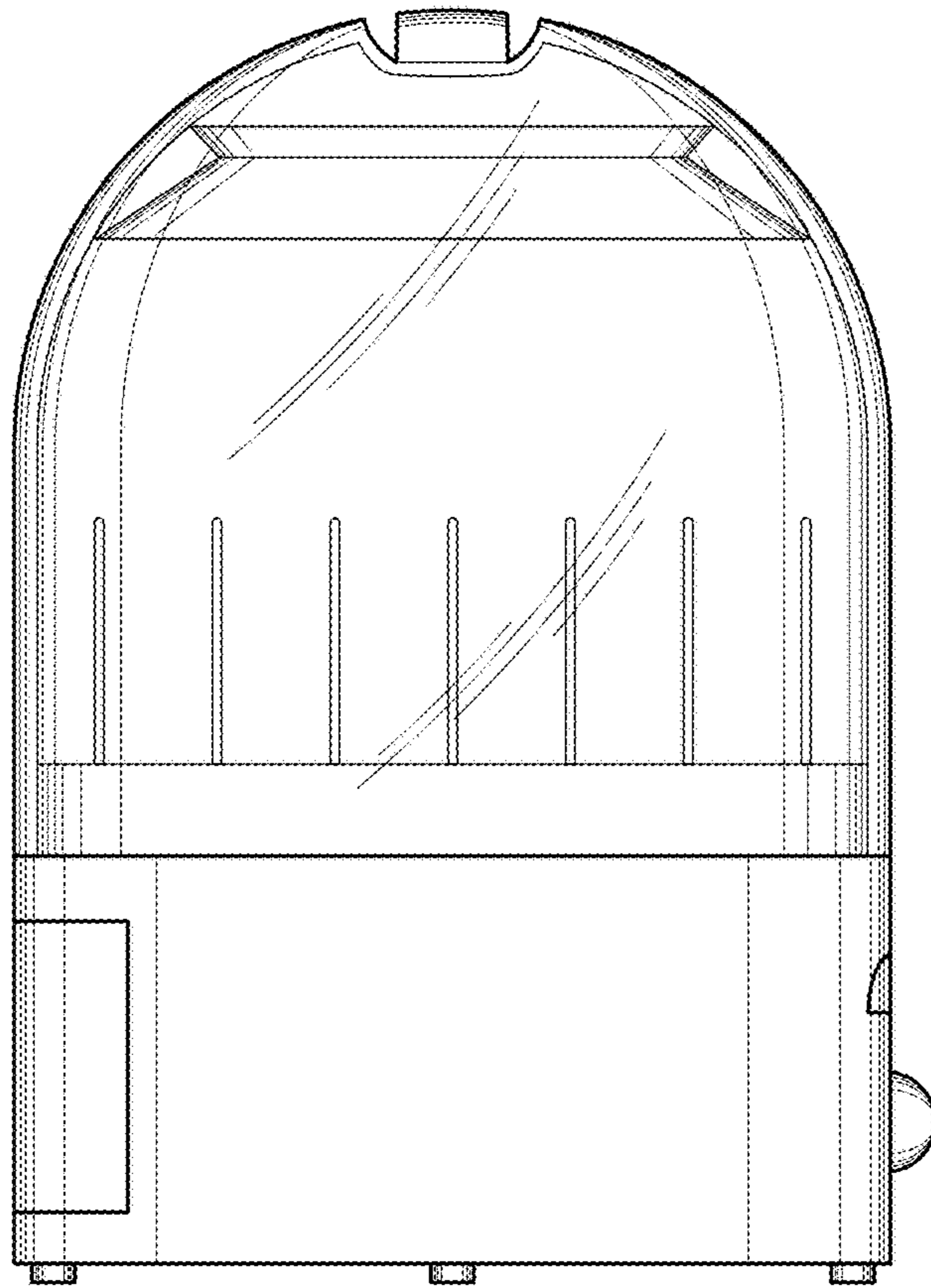

FIG. 4

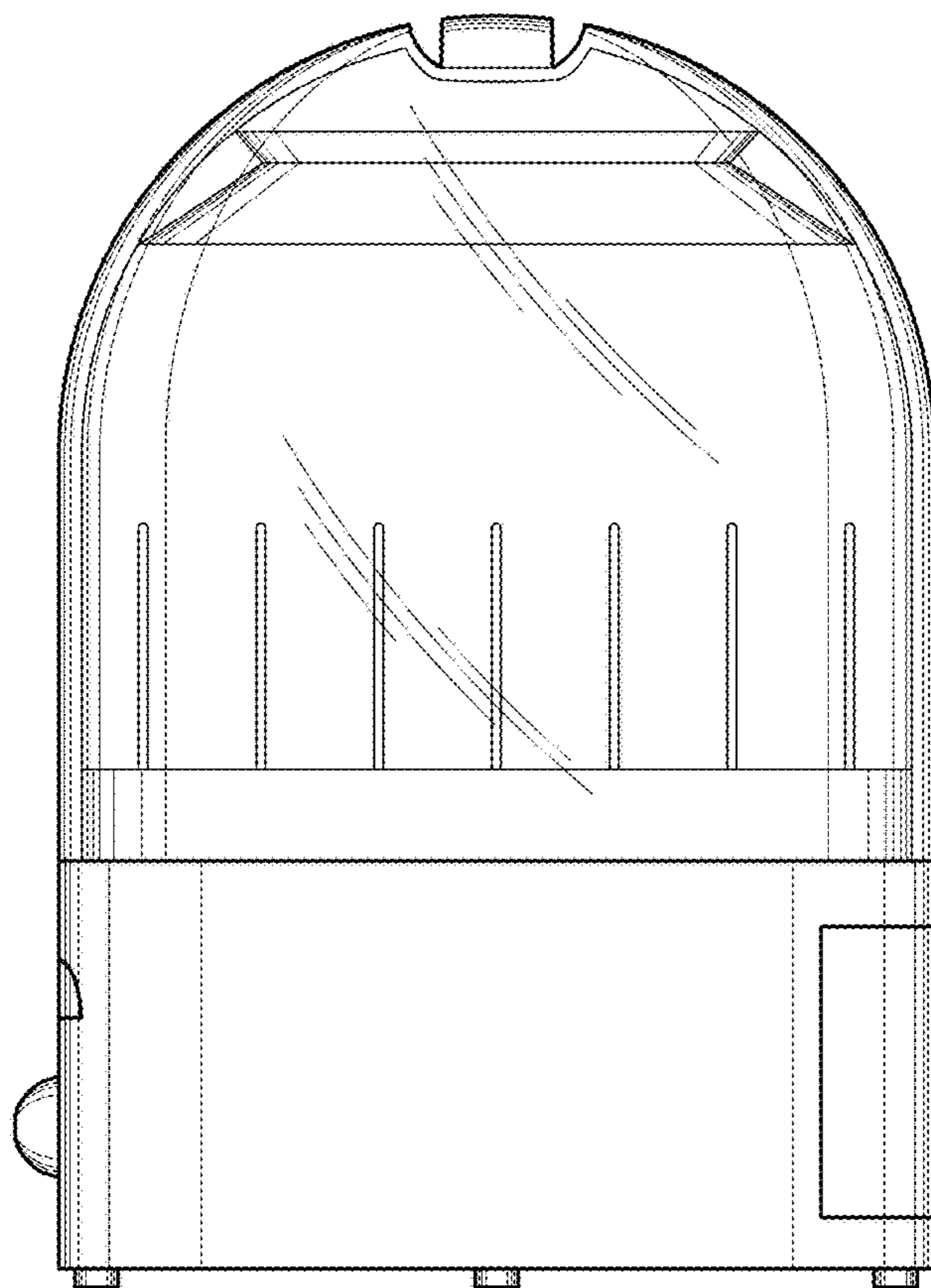

FIG. 5

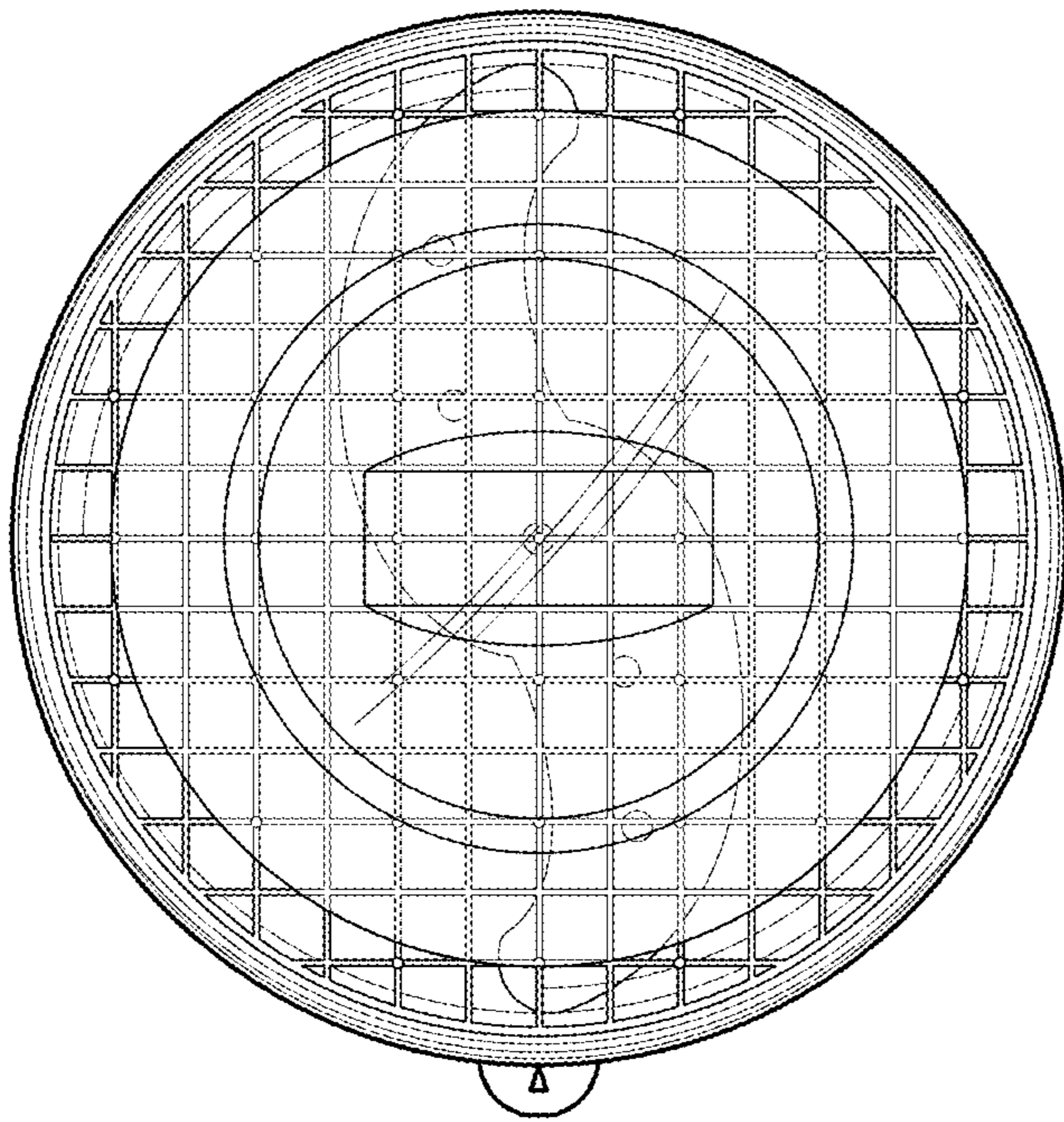

FIG. 6

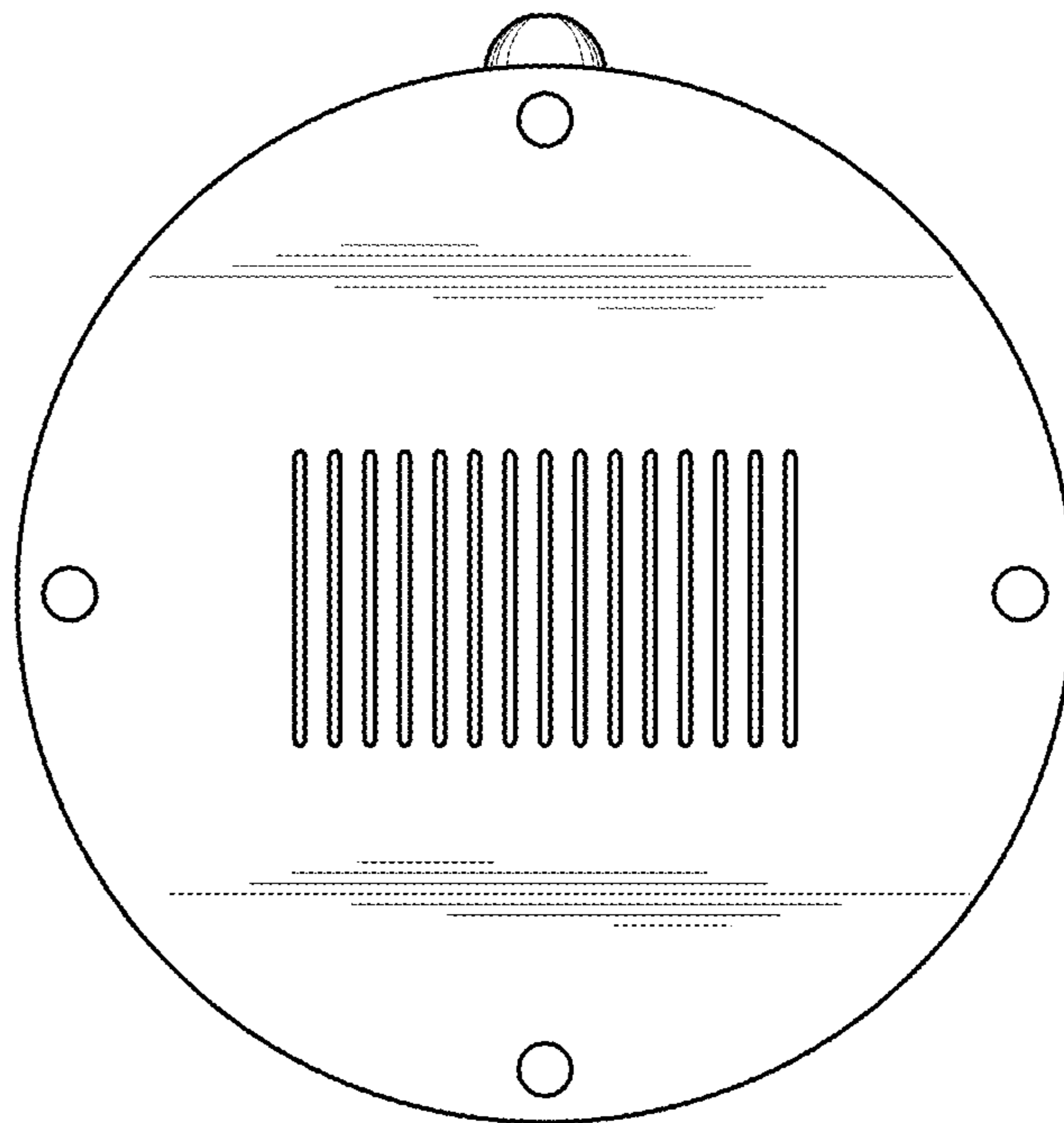

FIG. 7

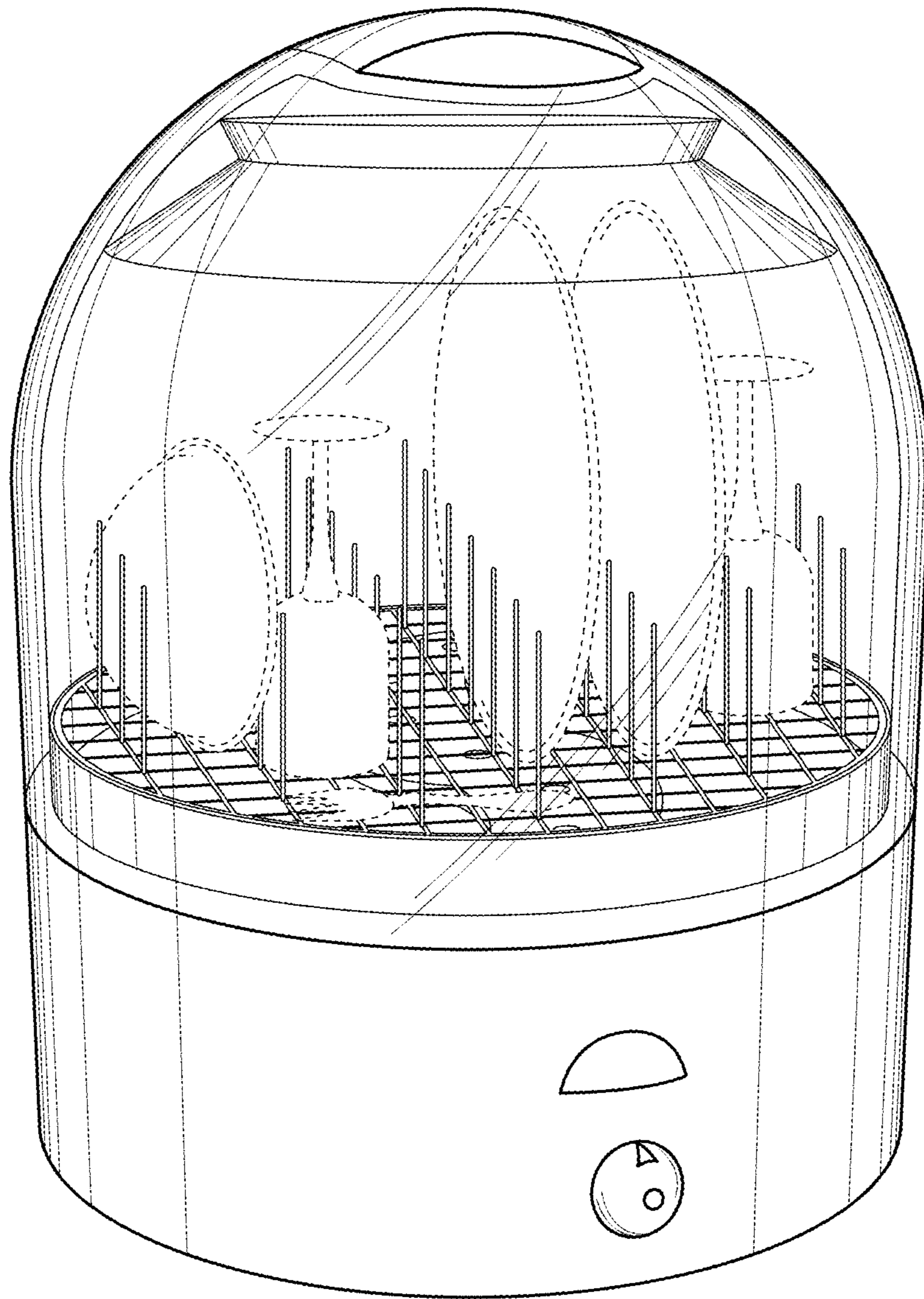

FIG. 8