



US00D785247S

(12) **United States Design Patent**
DoSouto

(10) **Patent No.:** **US D785,247 S**

(45) **Date of Patent:** **** Apr. 25, 2017**

(54) **SET OF THREE GOATEE TEMPLATES**

D662,258 S * 6/2012 Chapman D28/44.2
D768,332 S * 10/2016 Esnard D28/44.2
2003/0116172 A1* 6/2003 Bertucci A45D 24/36
132/214

(71) Applicant: **Carlitos DoSouto**, Los Angeles, CA
(US)

(Continued)

(72) Inventor: **Carlitos DoSouto**, Los Angeles, CA
(US)

Primary Examiner — Jennifer Rivard

(73) Assignee: **Carlitos DoSouto**, Los Angeles, CA
(US)

(57) **CLAIM**

I claim the ornamental design for a set of three goatee templates, as shown and described.

(**) Term: **15 Years**

DESCRIPTION

(21) Appl. No.: **29/558,731**

(22) Filed: **Mar. 21, 2016**

(51) **LOC (10) Cl.** **28-03**

(52) **U.S. Cl.**
USPC **D28/44.2**

(58) **Field of Classification Search**
USPC D28/9–10, 44.2
CPC A45D 24/36; A45D 24/06; A45D 24/08;
A45D 24/10; A45D 27/42
See application file for complete search history.

FIG. 1 is a front elevation view of the first goatee template of the set of three goatee templates;
FIG. 2 is a perspective view thereof;
FIG. 3 is a front elevation view thereof;
FIG. 4 is a rear elevation view thereof;
FIG. 5 is a left side elevation view thereof;
FIG. 6 is a top plan view thereof;
FIG. 7 is a bottom plan view thereof;
FIG. 8 is a front elevation view of the second goatee template of the set of three goatee templates;
FIG. 9 is a perspective view thereof;
FIG. 10 is a front elevation view thereof;
FIG. 11 is a rear elevation view thereof;
FIG. 12 is a left side elevation view thereof;
FIG. 13 is a top plan view thereof;
FIG. 14 is a bottom plan view thereof;
FIG. 15 is a front elevation view of the third goatee template of the set of three goatee templates;
FIG. 16 is a perspective view thereof;
FIG. 17 is a front elevation view thereof;
FIG. 18 is a rear elevation view thereof;
FIG. 19 is a left side elevation view thereof;
FIG. 20 is a top plan view thereof; and,
FIG. 21 is a bottom plan view thereof.

The broken lines illustrate the environment of the set of three goatee templates and form no part of the claimed design. The three goatee templates are shown separately for convenience of illustration.

(56) **References Cited**

U.S. PATENT DOCUMENTS

4,003,390 A * 1/1977 Solie A45D 24/36
132/213
5,427,122 A * 6/1995 Hamilton A45D 24/36
132/214
5,494,057 A * 2/1996 Gianfrancesco A45D 24/36
132/200
7,559,331 B2 * 7/2009 Ward A45D 24/36
132/214
D634,893 S * 3/2011 Brown D28/10
D642,740 S * 8/2011 Chiodo D28/44
8,082,927 B2 * 12/2011 Bonge A45D 27/42
132/214

1 Claim, 12 Drawing Sheets

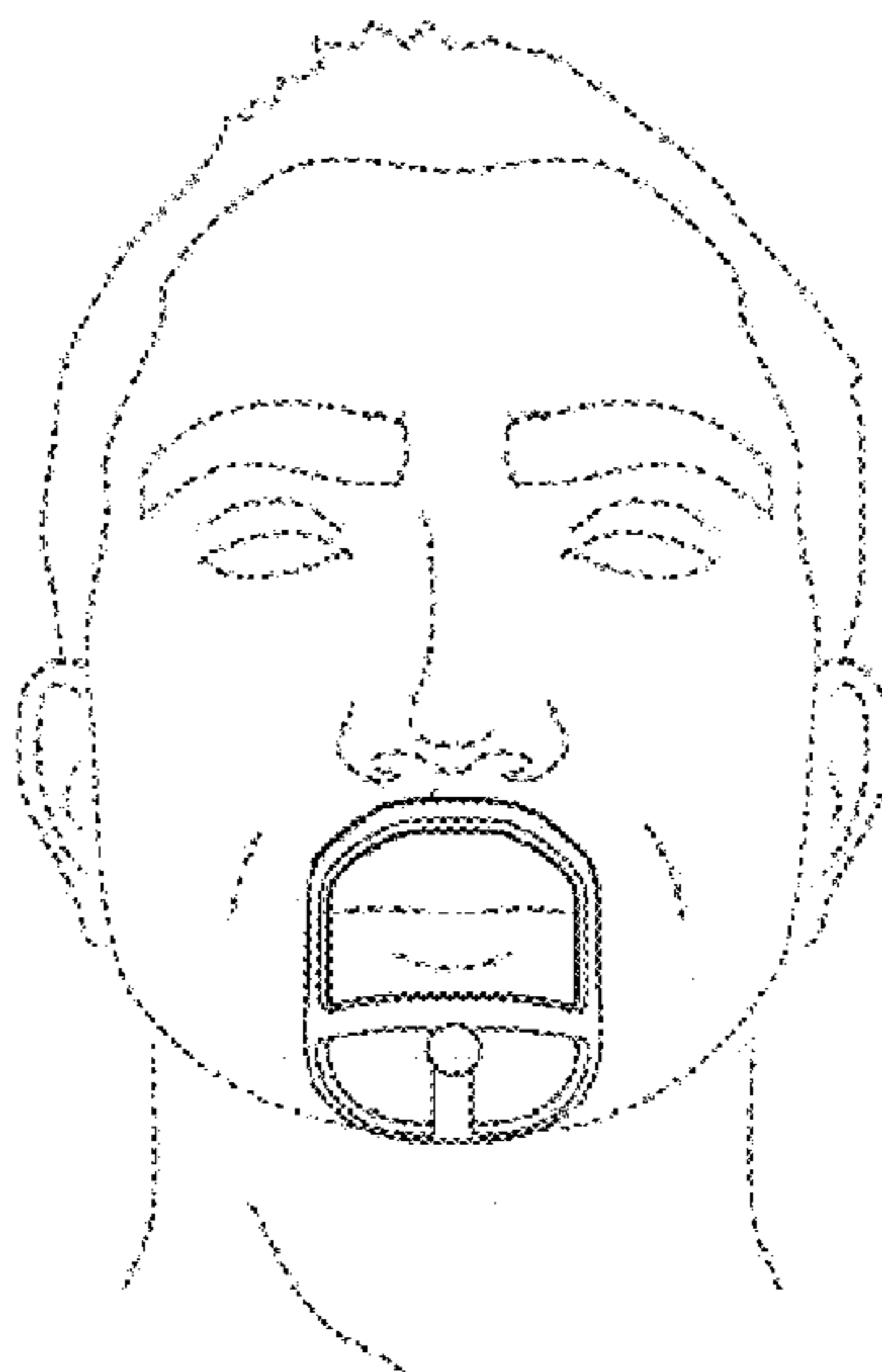

(56)

References Cited

U.S. PATENT DOCUMENTS

2004/0074511 A1* 4/2004 Sussan A45D 24/36
132/214
2013/0213429 A1* 8/2013 Allen A45D 27/42
132/214
2015/0027281 A1* 1/2015 Andrade A45D 24/36
83/13
2016/0250762 A1* 9/2016 Eljaouhari B26B 19/14
2016/0309876 A1* 10/2016 Brunett A45D 24/02

* cited by examiner

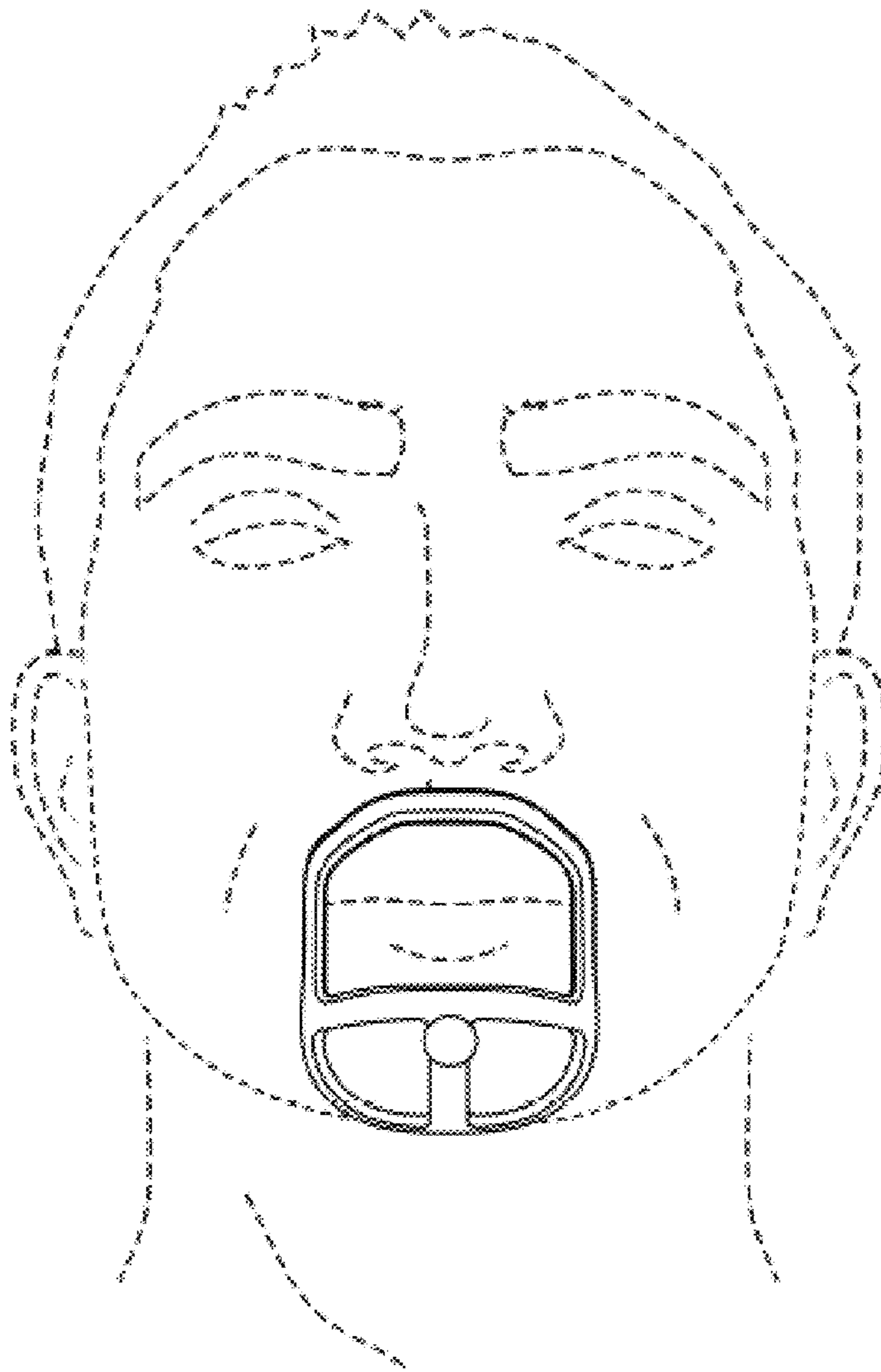

Fig. 1

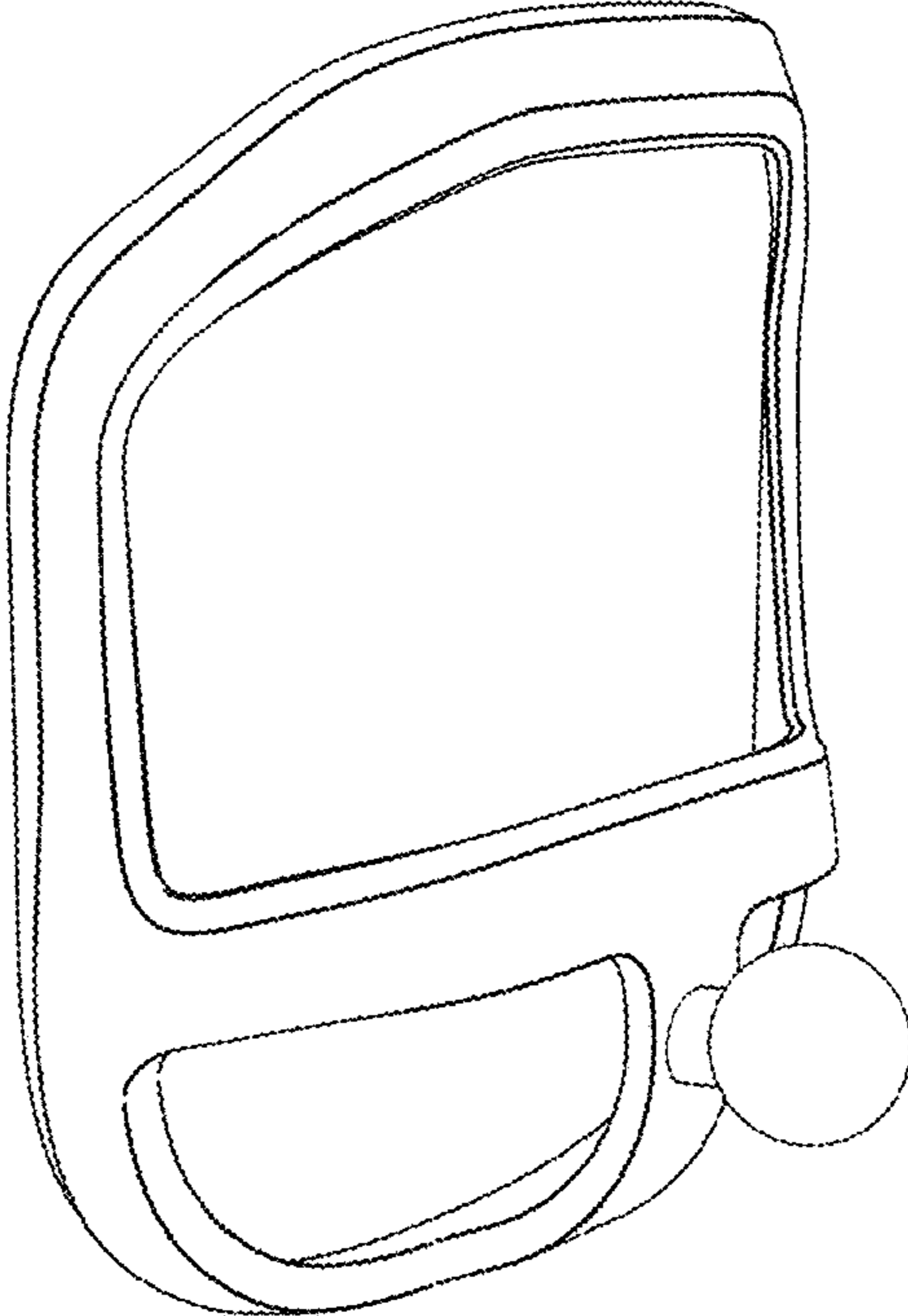

Fig. 2

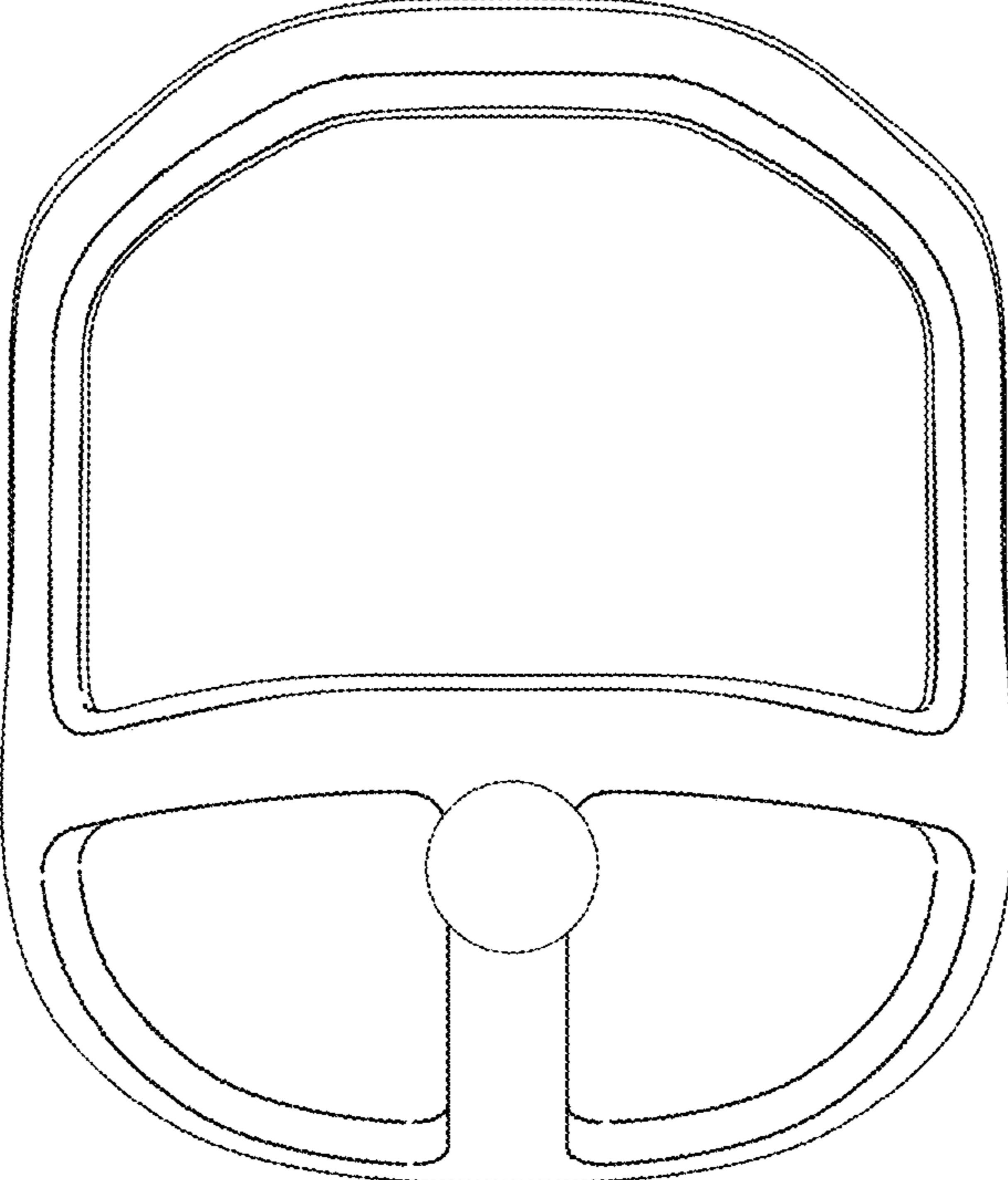

Fig. 3

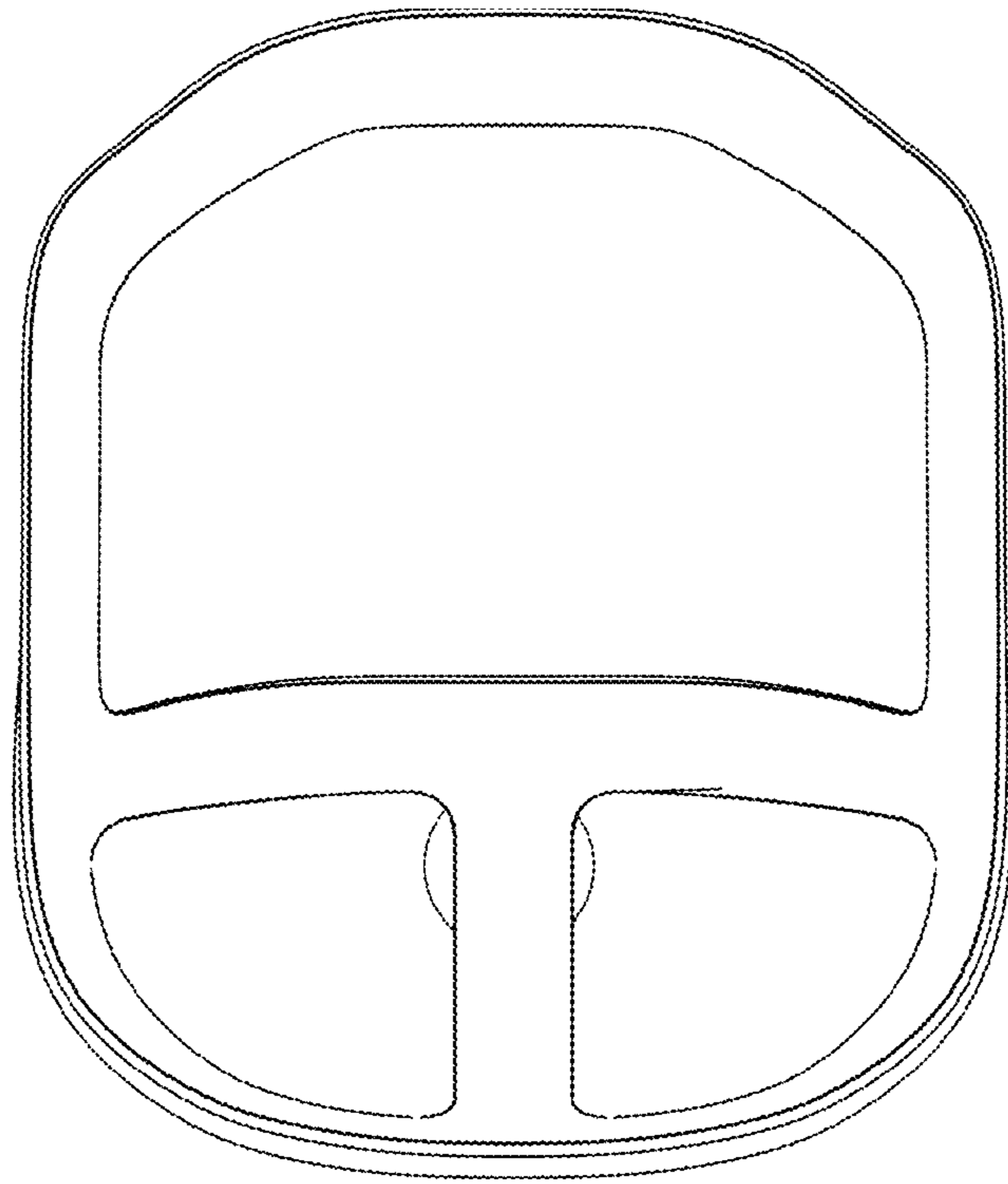

Fig. 4

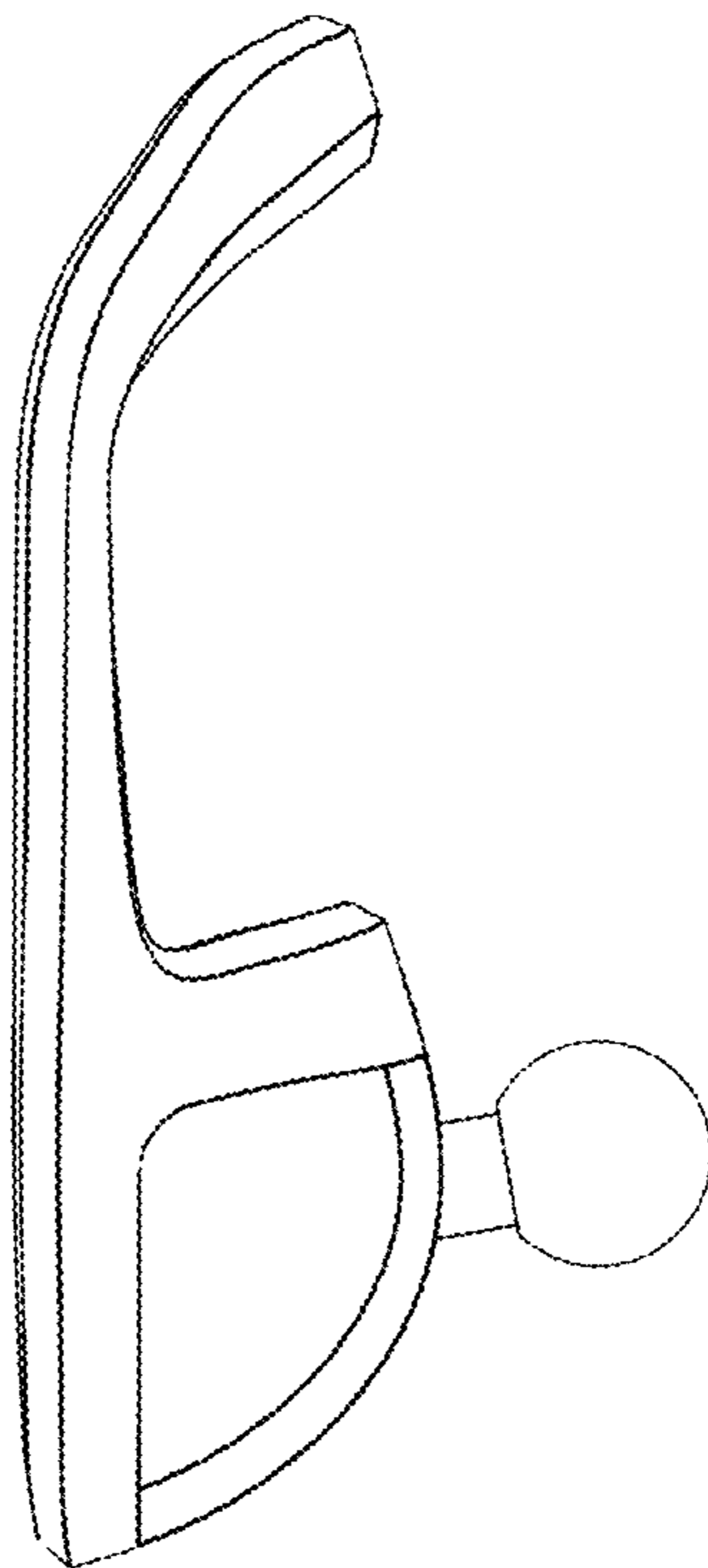

Fig. 5

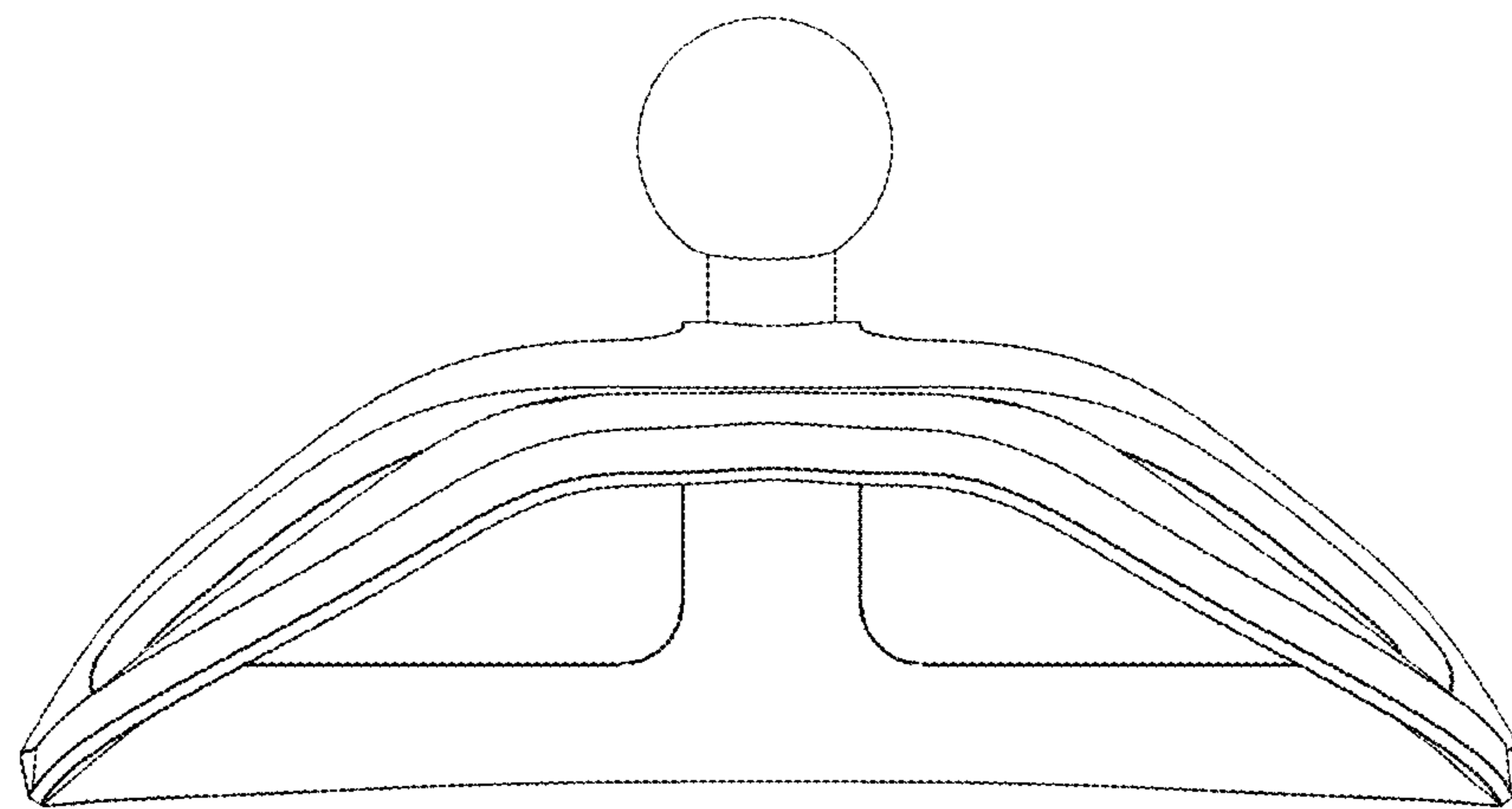

Fig. 6

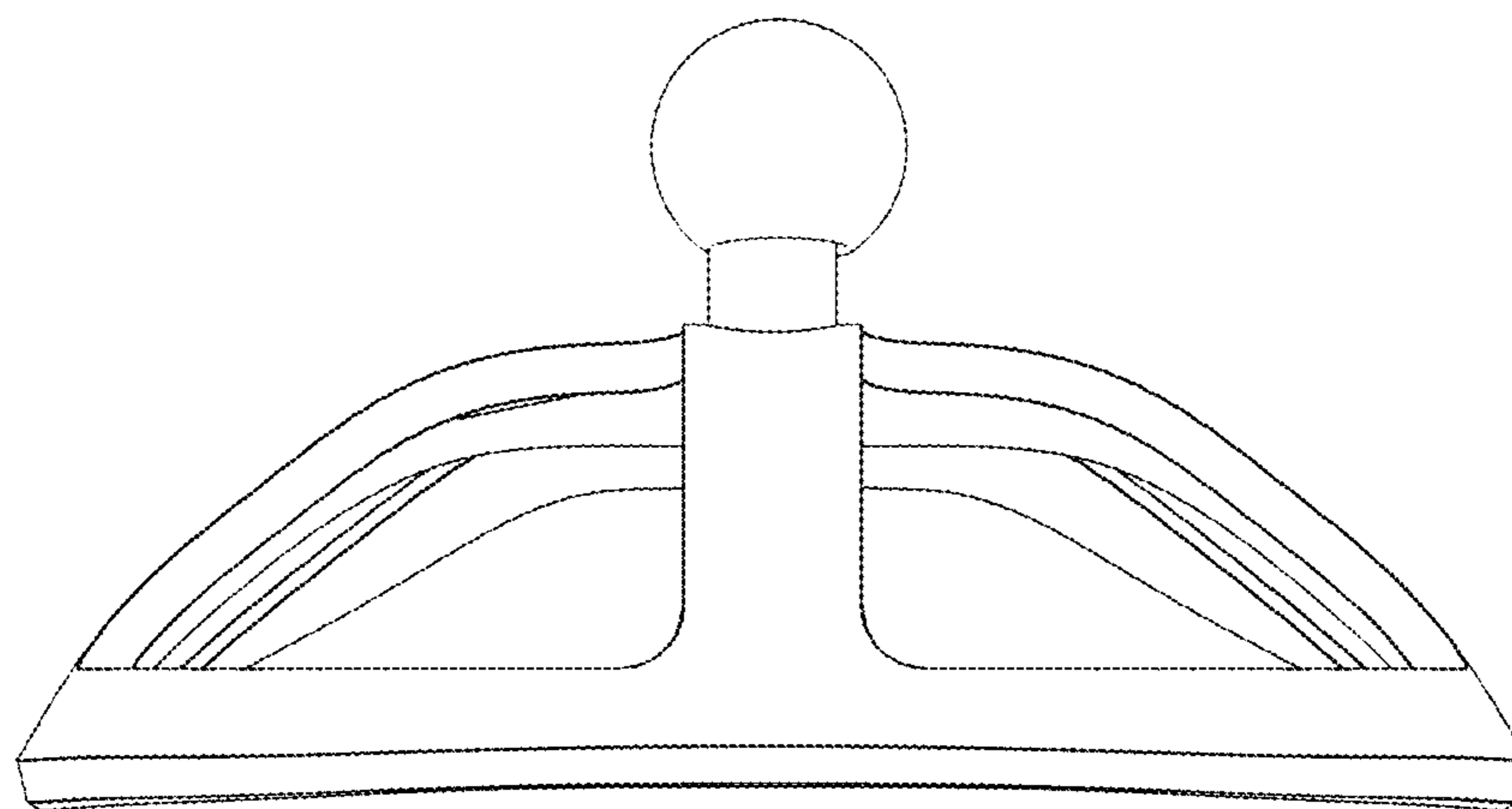

Fig. 7

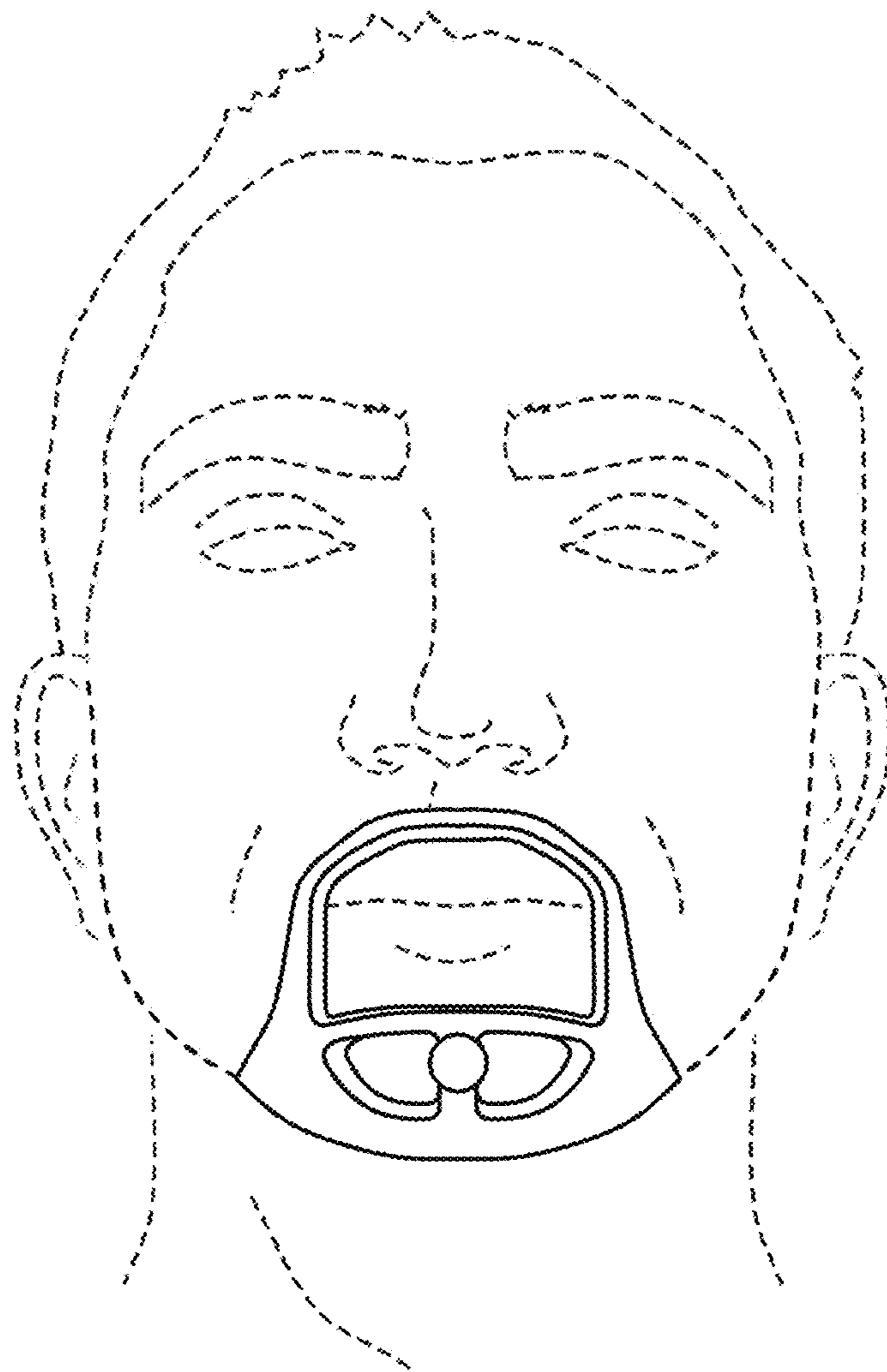

Fig.8

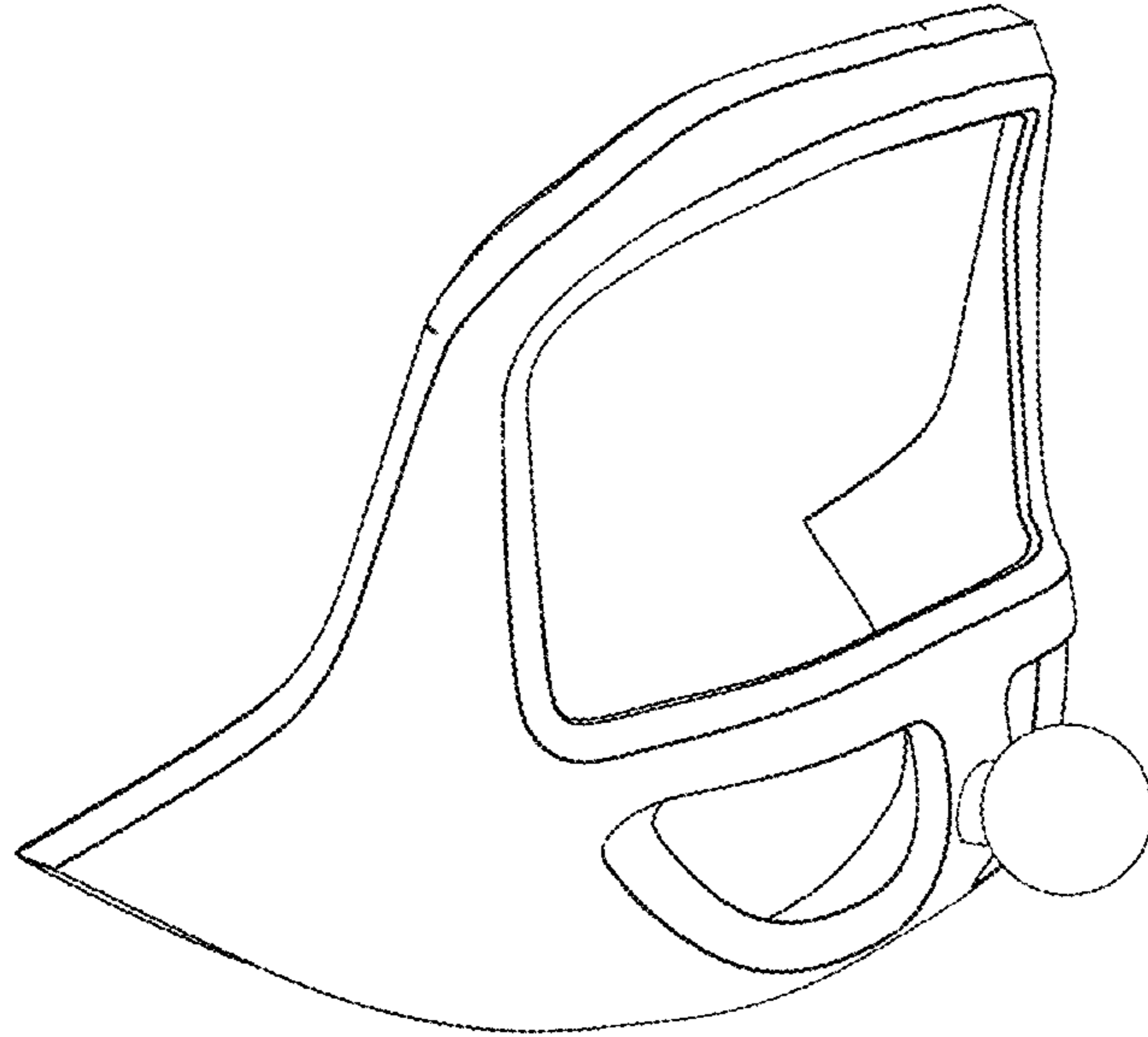

Fig. 9

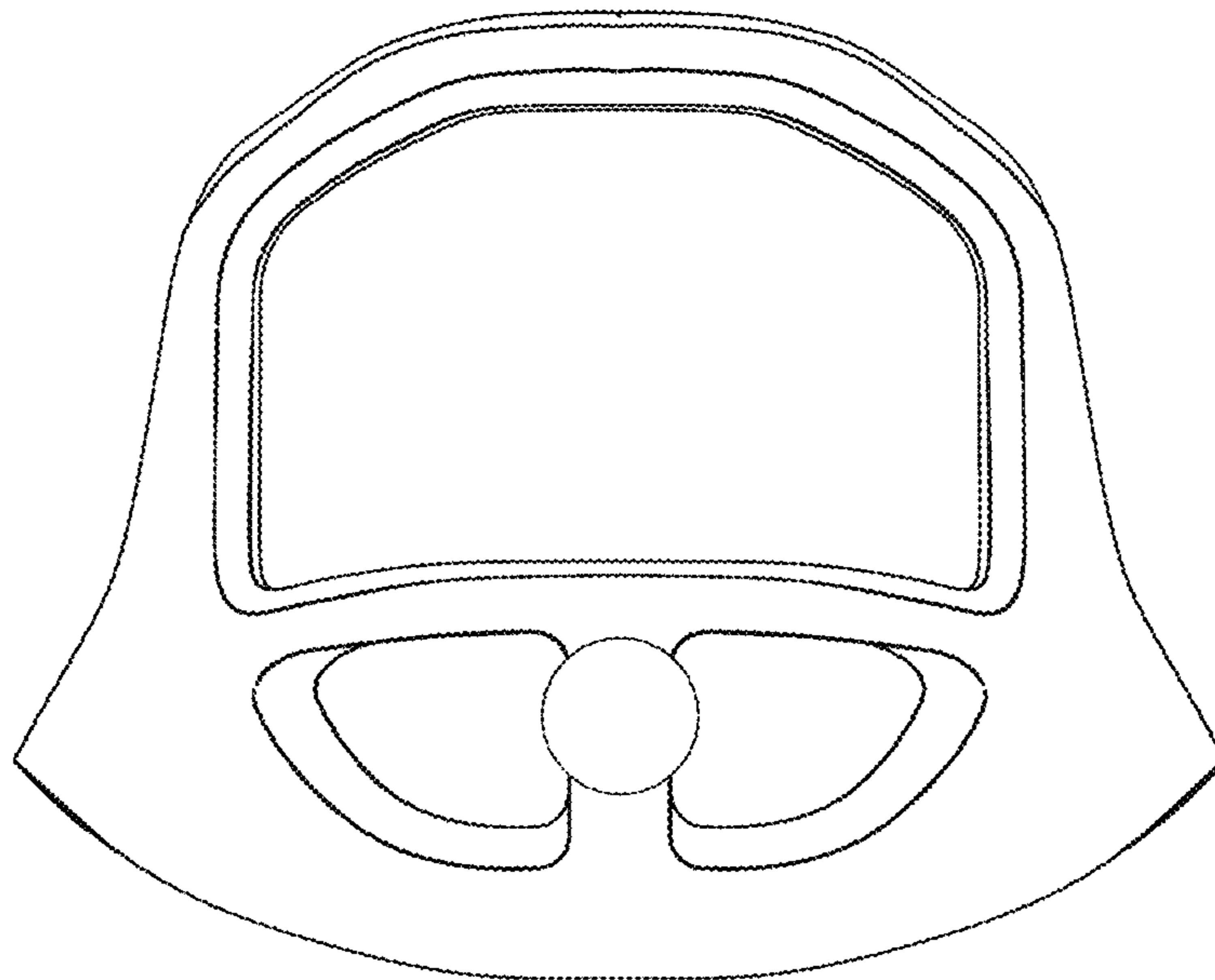

Fig. 10

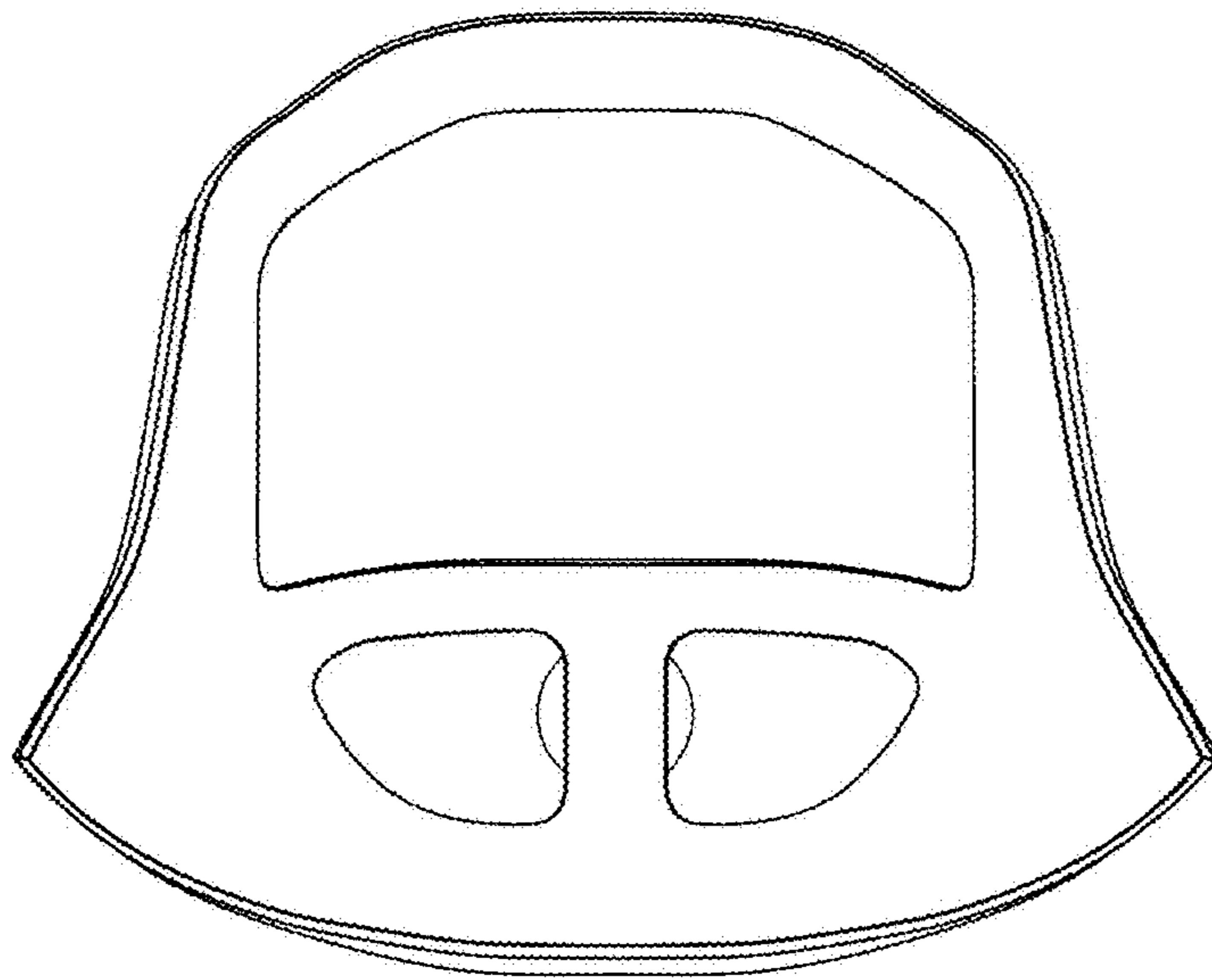

Fig. 11

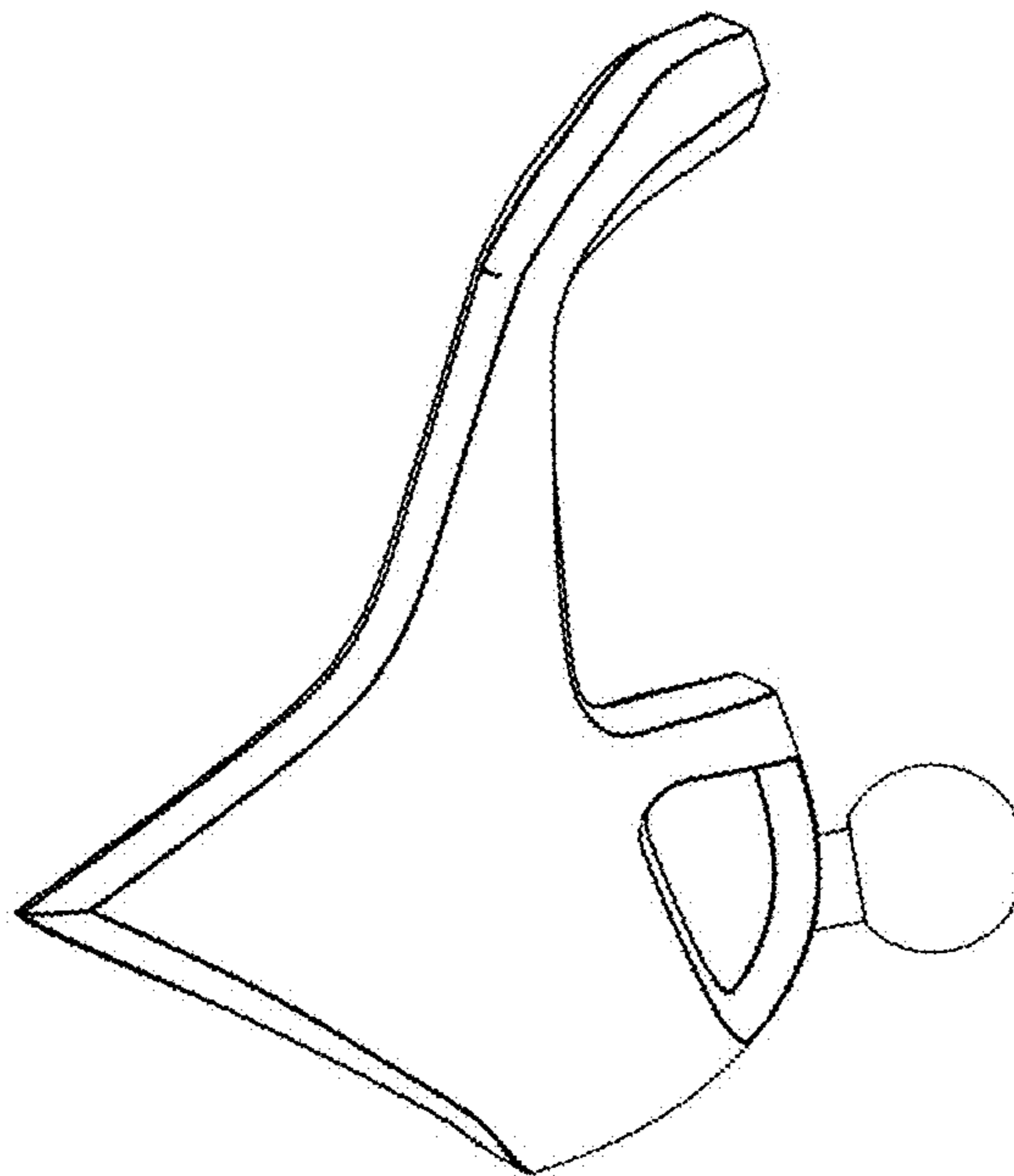

Fig. 12

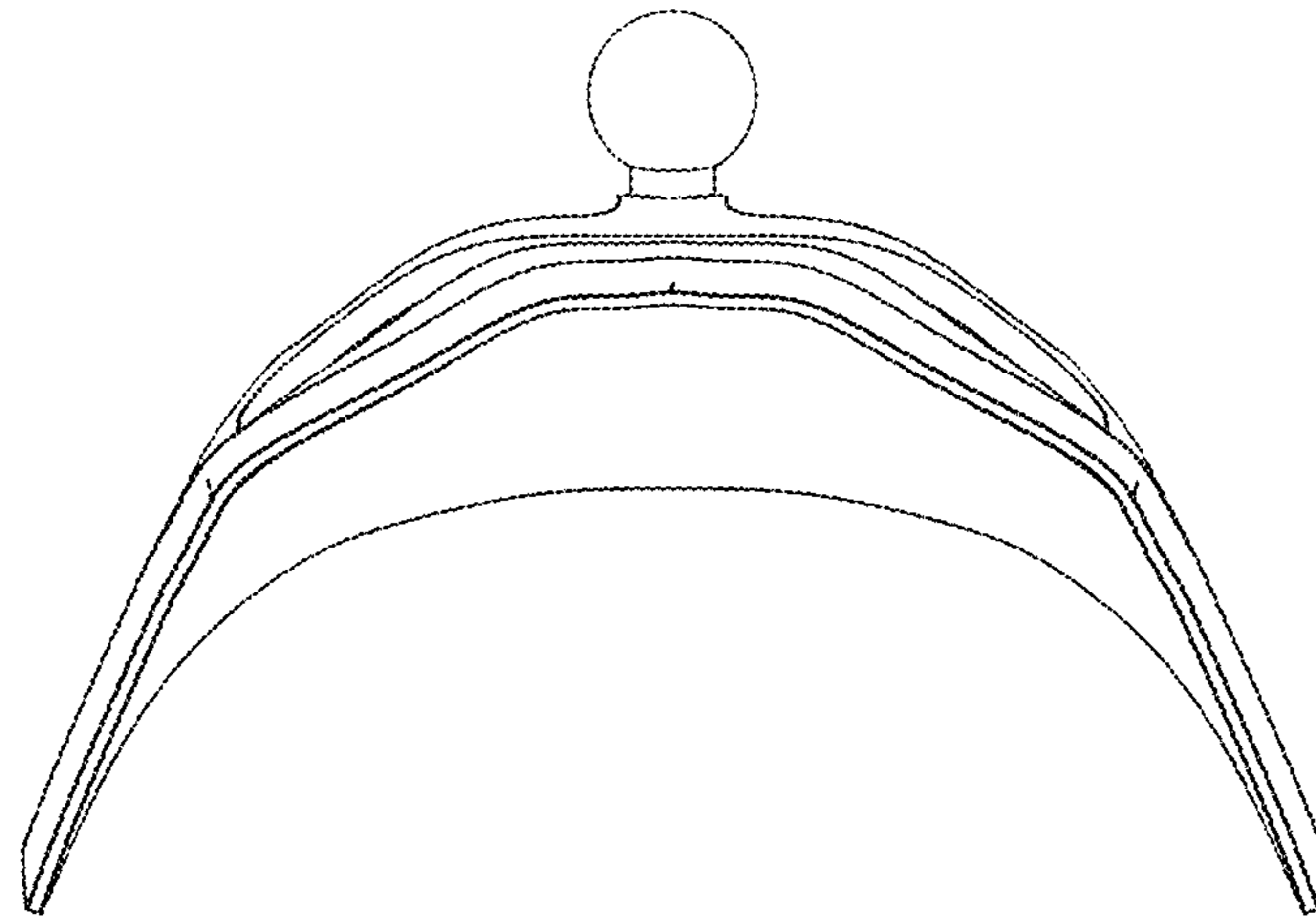

Fig. 13

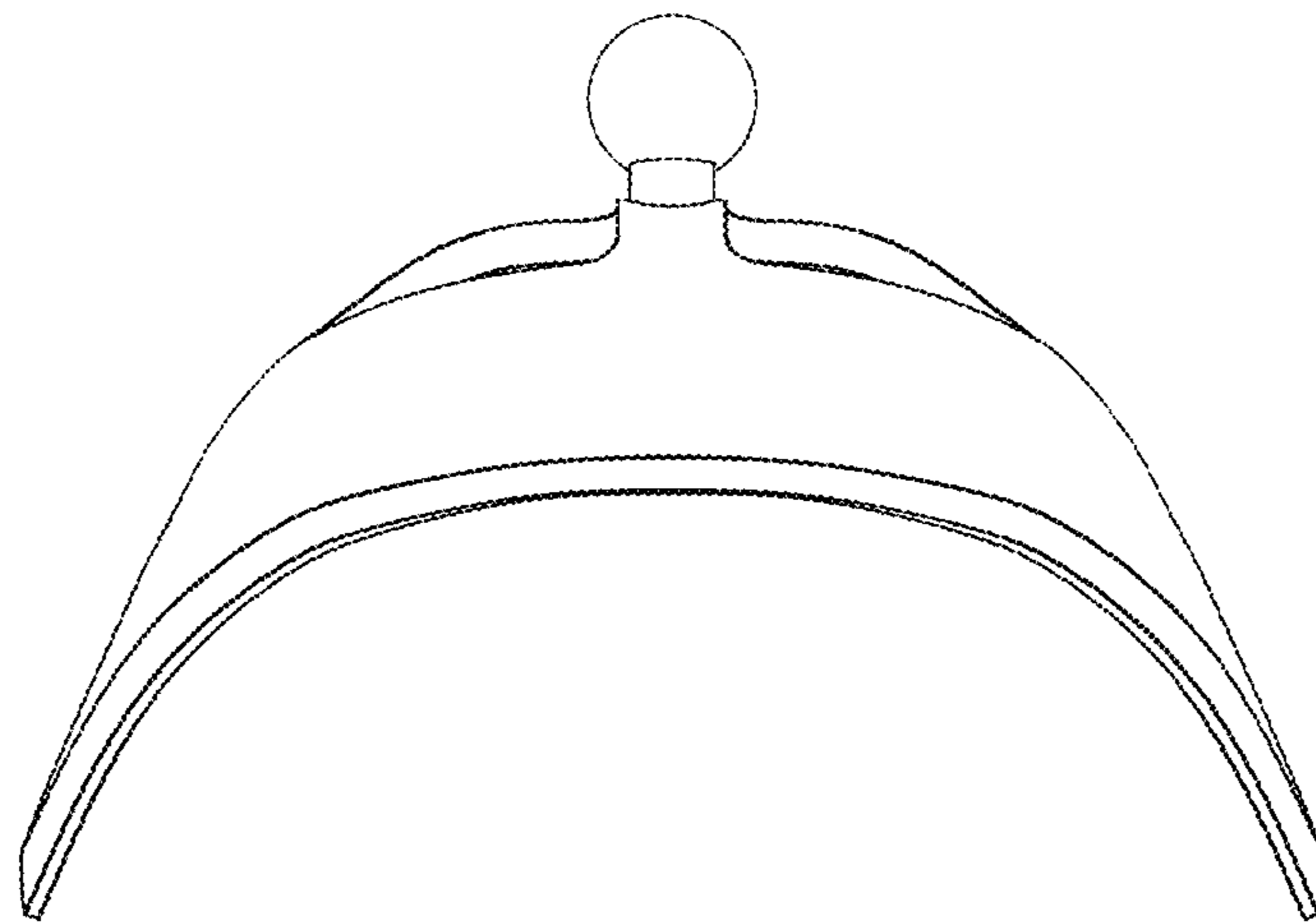

Fig. 14

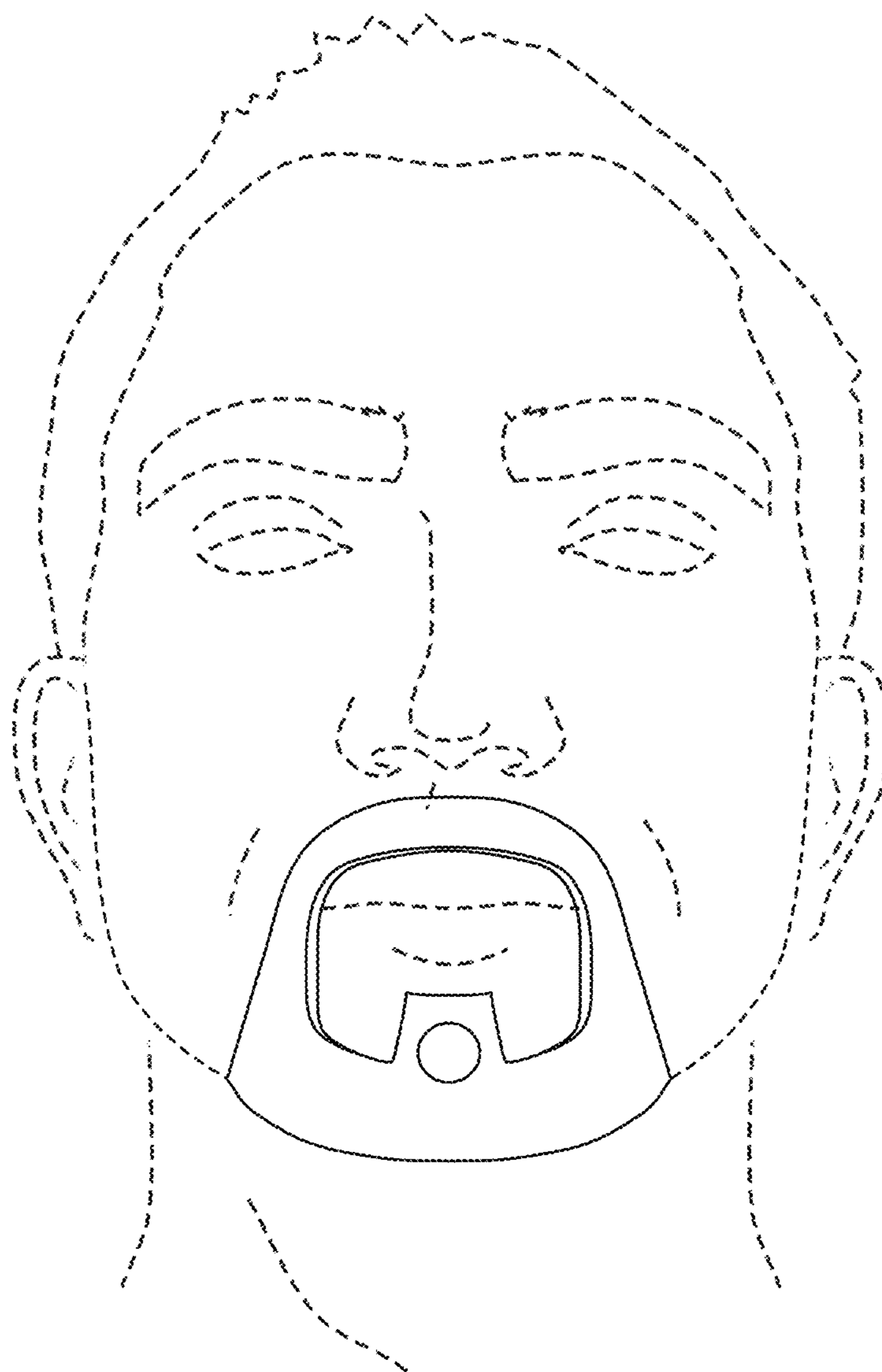

Fig.15

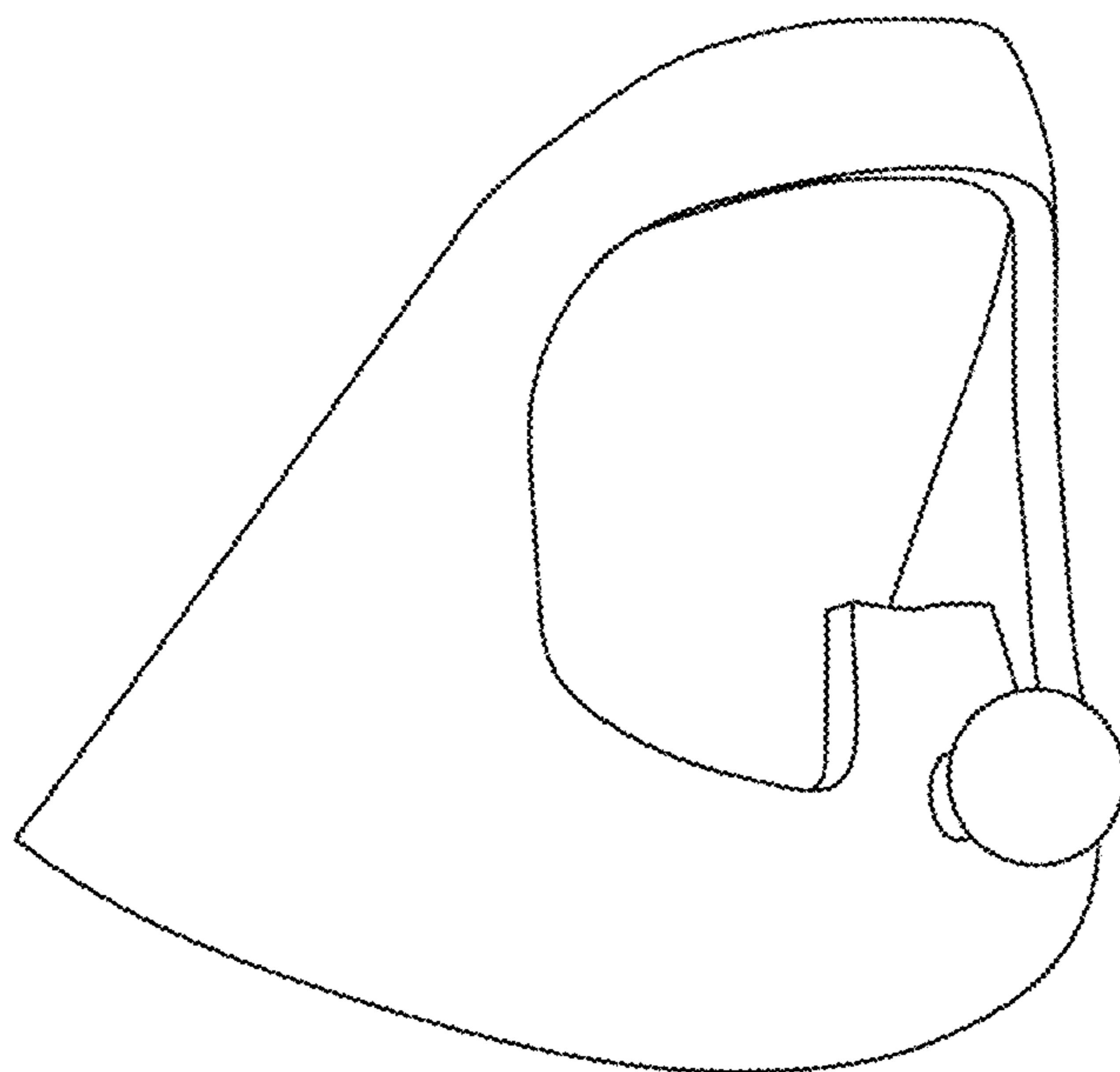

Fig. 16

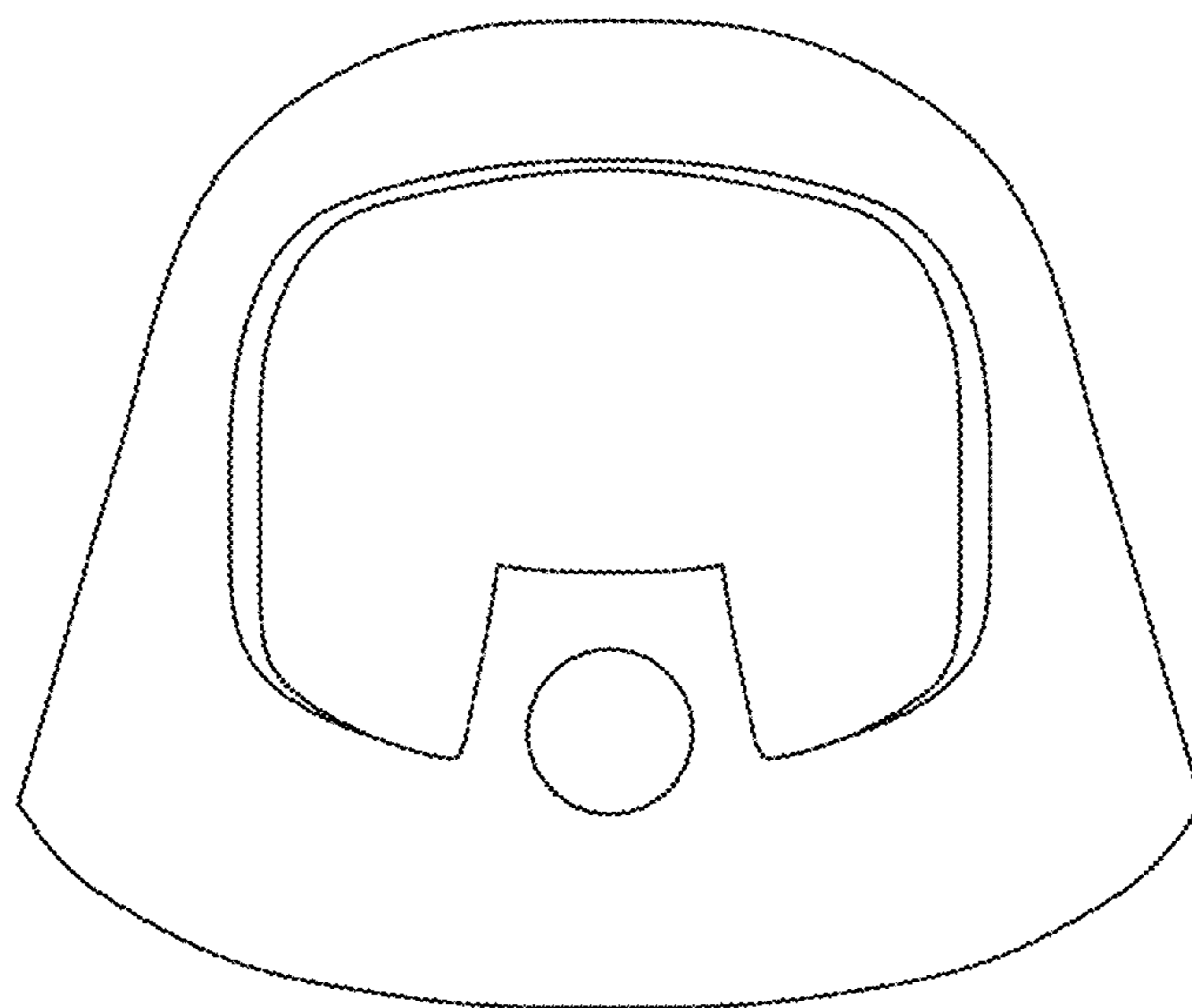

Fig. 17

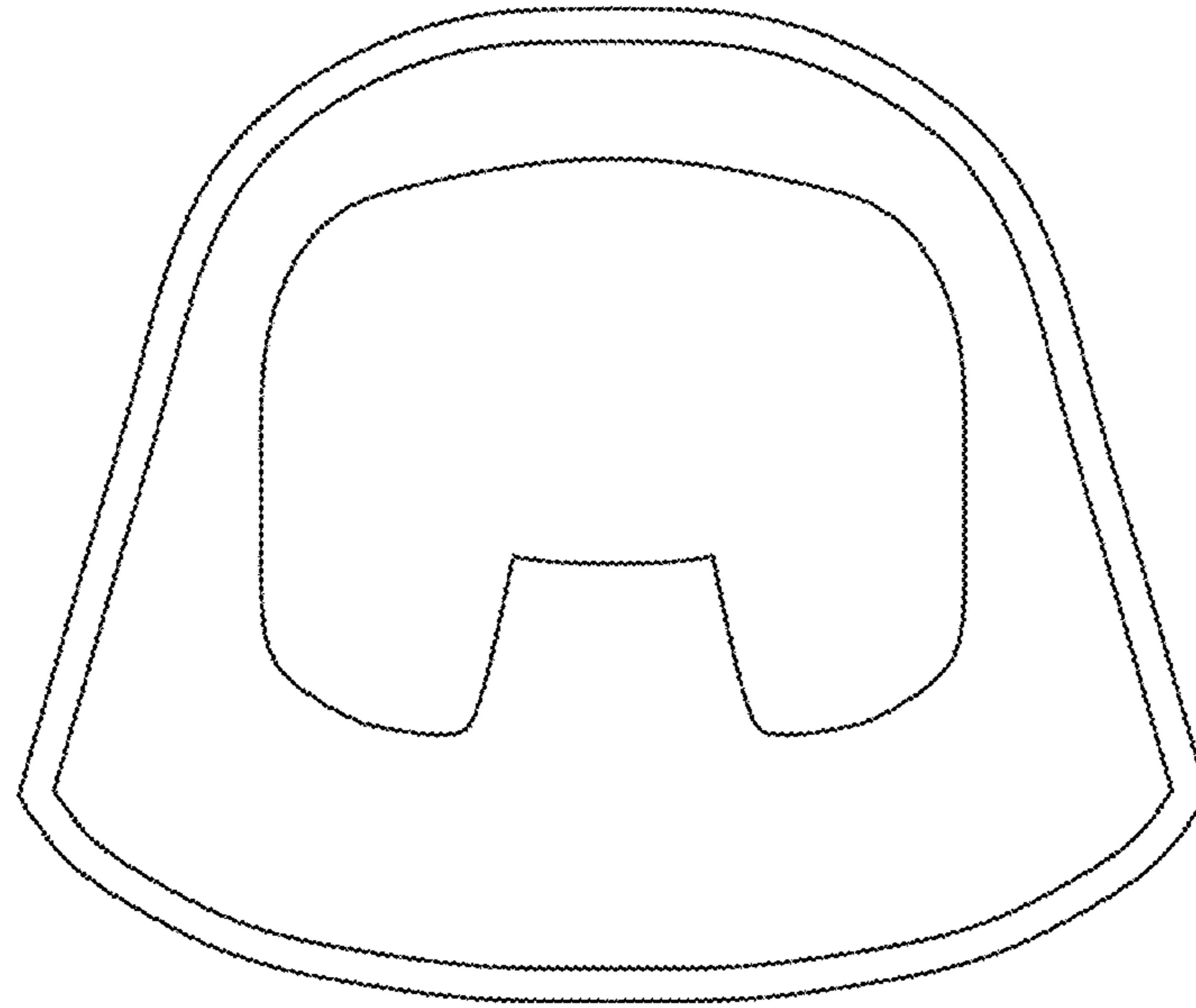

Fig. 18

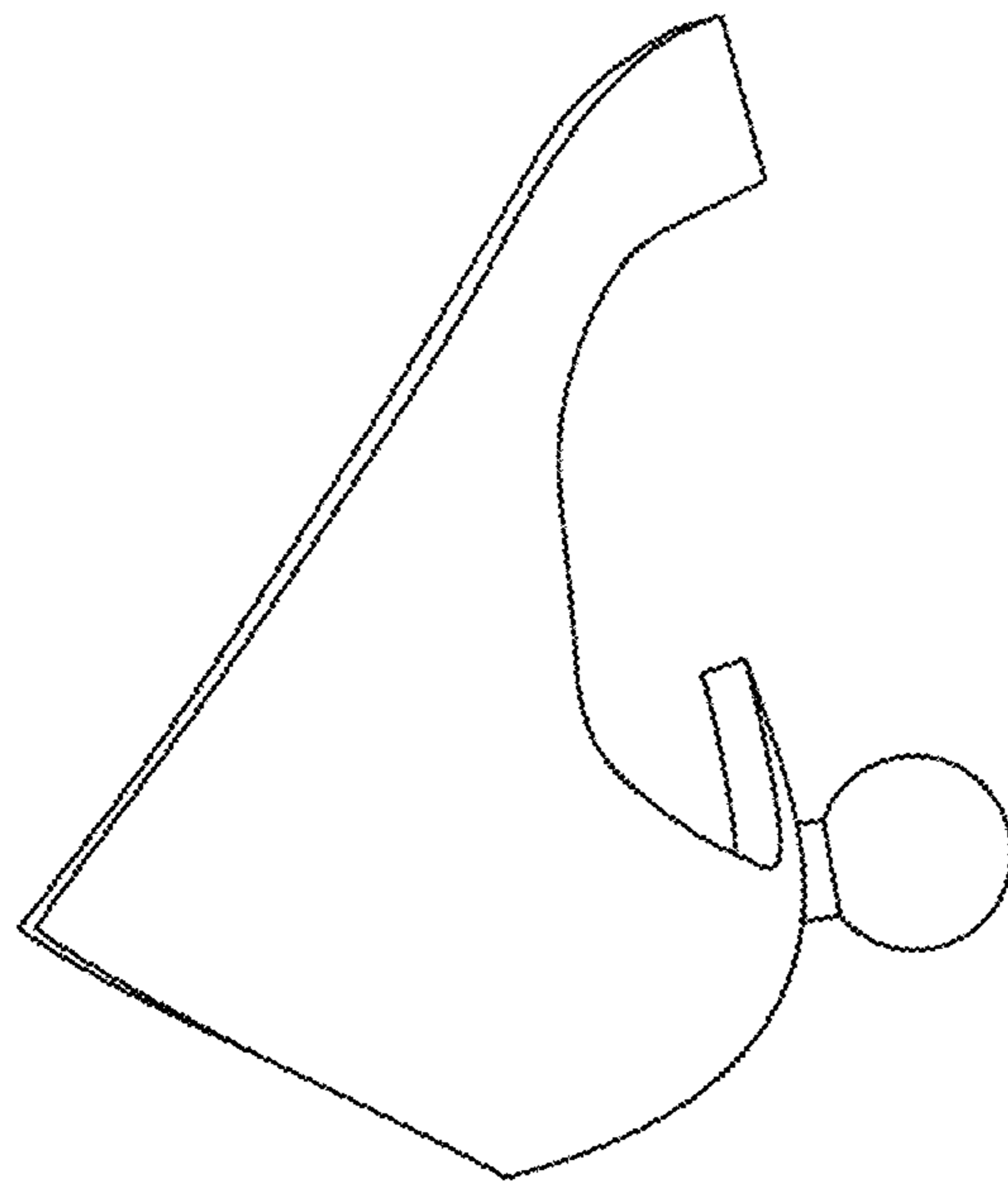

Fig. 19

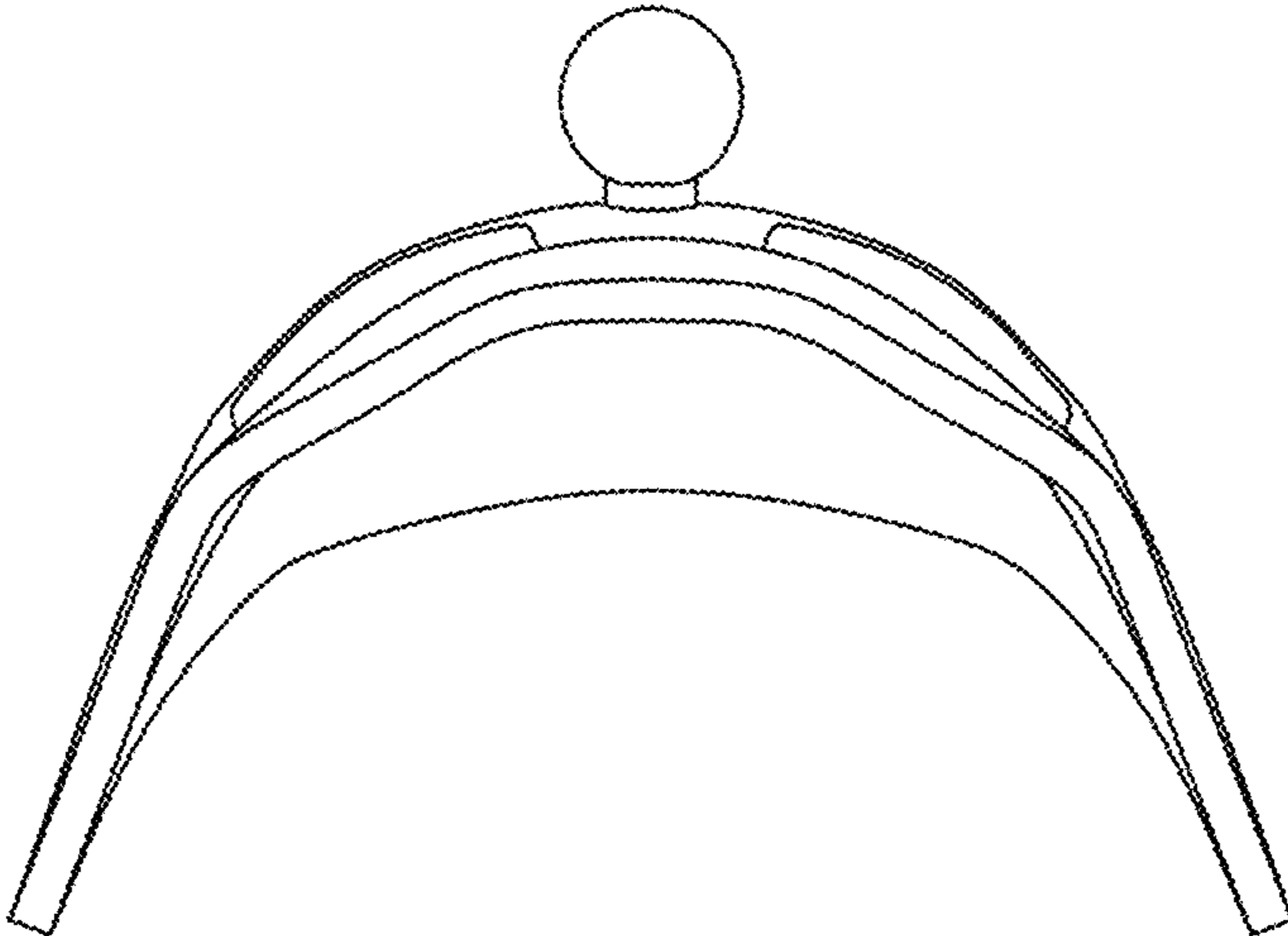

Fig. 20

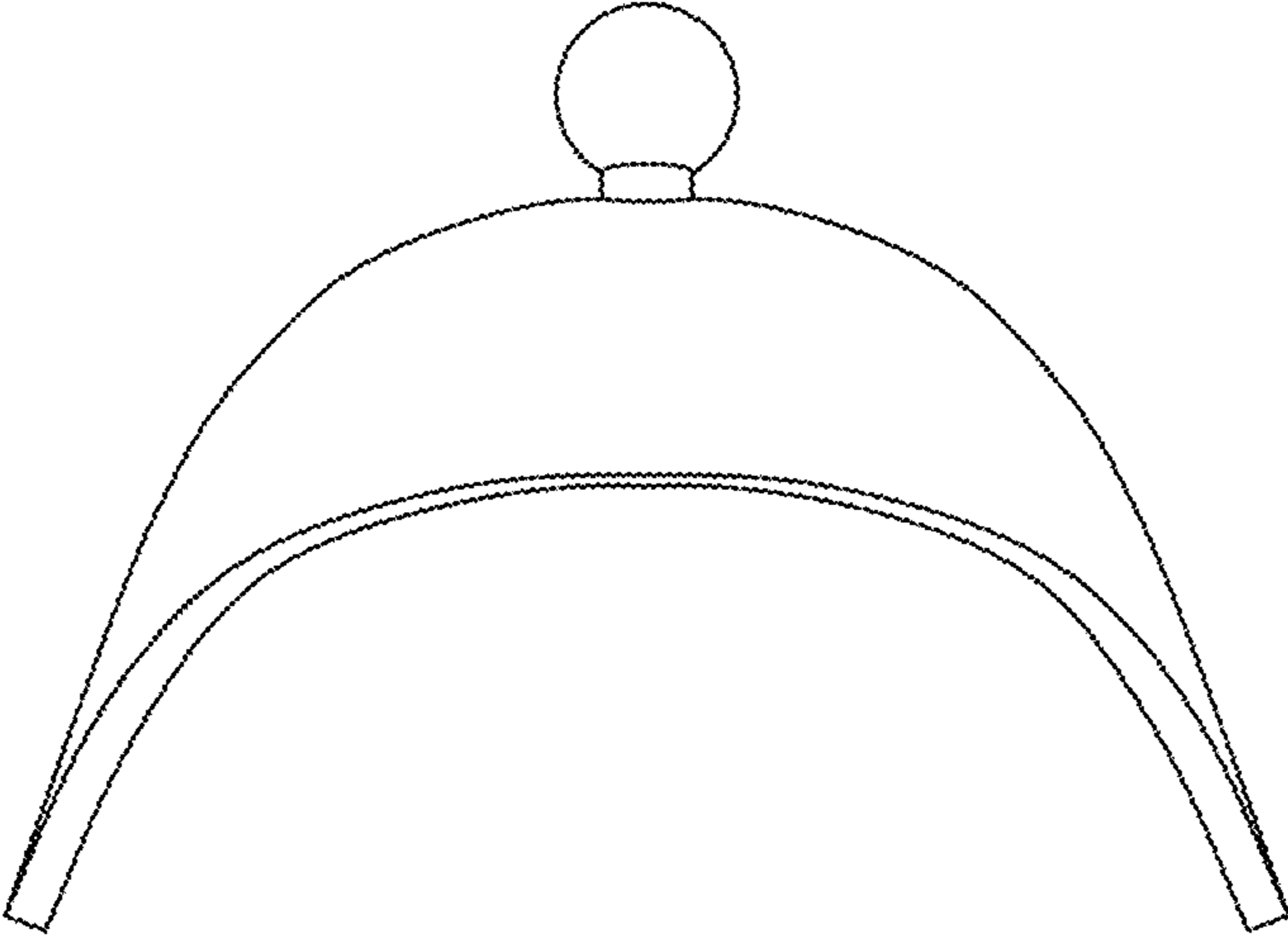

Fig. 21