



US00D785191S

(12) **United States Design Patent**
Lee et al.

(10) **Patent No.:** **US D785,191 S**
(45) **Date of Patent:** **** Apr. 25, 2017**

- (54) **WALKING FRAME**
- (71) Applicant: **Samsung Electronics Co., Ltd.**,
Suwon-si, Gyeonggi-do (KR)
- (72) Inventors: **Seo Lee**, Yongin-si (KR); **Baekki Kim**,
Seoul (KR); **Jongchan Kwon**,
Yongin-si (KR); **Sangsung Woo**, Seoul
(KR); **Yangjic Lee**, Gwacheon-si (KR)
- (73) Assignee: **SAMSUNG ELECTRONICS CO.,**
LTD., Suwon-si, Gyeonggi-Do (KR)

- (**) Term: **15 Years**
- (21) Appl. No.: **29/541,340**
- (22) Filed: **Oct. 2, 2015**

(30) **Foreign Application Priority Data**

Apr. 3, 2015 (KR) 30-2015-0017158

- (51) **LOC (10) Cl.** **24-04**
- (52) **U.S. Cl.**
USPC **D24/190**
- (58) **Field of Classification Search**
USPC D24/190
CPC A61F 5/028; A61F 5/0193; A61F 5/0123;
A61F 5/024; A61F 5/026; A61F 5/0125;
A61F 5/0102; A41D 13/0015; A41D
13/0506; A61H 2201/165
See application file for complete search history.

(56) **References Cited**

U.S. PATENT DOCUMENTS

- 4,905,678 A * 3/1990 Cumins A61F 5/0193
602/16
- 5,840,050 A * 11/1998 Lerman A61F 5/0193
602/19
- 6,027,466 A * 2/2000 Diefenbacher A61F 5/0125
602/16

- 6,039,707 A * 3/2000 Crawford A61F 5/0193
602/18
- 6,090,057 A * 7/2000 Collins A61F 5/0193
602/16
- 6,488,644 B1 * 12/2002 Ostrom A61F 5/0193
403/87
- 6,769,134 B1 * 8/2004 Mendez A41D 13/065
2/22
- D527,825 S 9/2006 Ingimundarson et al.
- 7,597,672 B2 * 10/2009 Kruijssen A61F 5/0193
128/117.1
- D720,860 S 1/2015 Meyer et al.
(Continued)

FOREIGN PATENT DOCUMENTS

- EM 001834615-0001 3/2011
- EM 001924853-0001 9/2011

OTHER PUBLICATIONS

CTi OA (Custom): <http://www.activ8rehab.co.uk/knee-brace-centre.php> downloaded Jan. 5, 2017.

Primary Examiner — George D Kirschbaum
Assistant Examiner — Jennifer Watkins
(74) *Attorney, Agent, or Firm* — Ladas & Parry LLP

(57) **CLAIM**

We claim the ornamental design for a walking frame, as shown and described.

DESCRIPTION

FIG. 1 is a front perspective view of a walking frame showing our new design.
FIG. 2 is a front view thereof;
FIG. 3 is a rear view thereof;
FIG. 4 is a left-side view thereof;
FIG. 5 is a right-side view thereof;
FIG. 6 is a top view thereof;
FIG. 7 is a bottom view thereof; and,
FIG. 8 is a rear perspective view thereof.

1 Claim, 7 Drawing Sheets

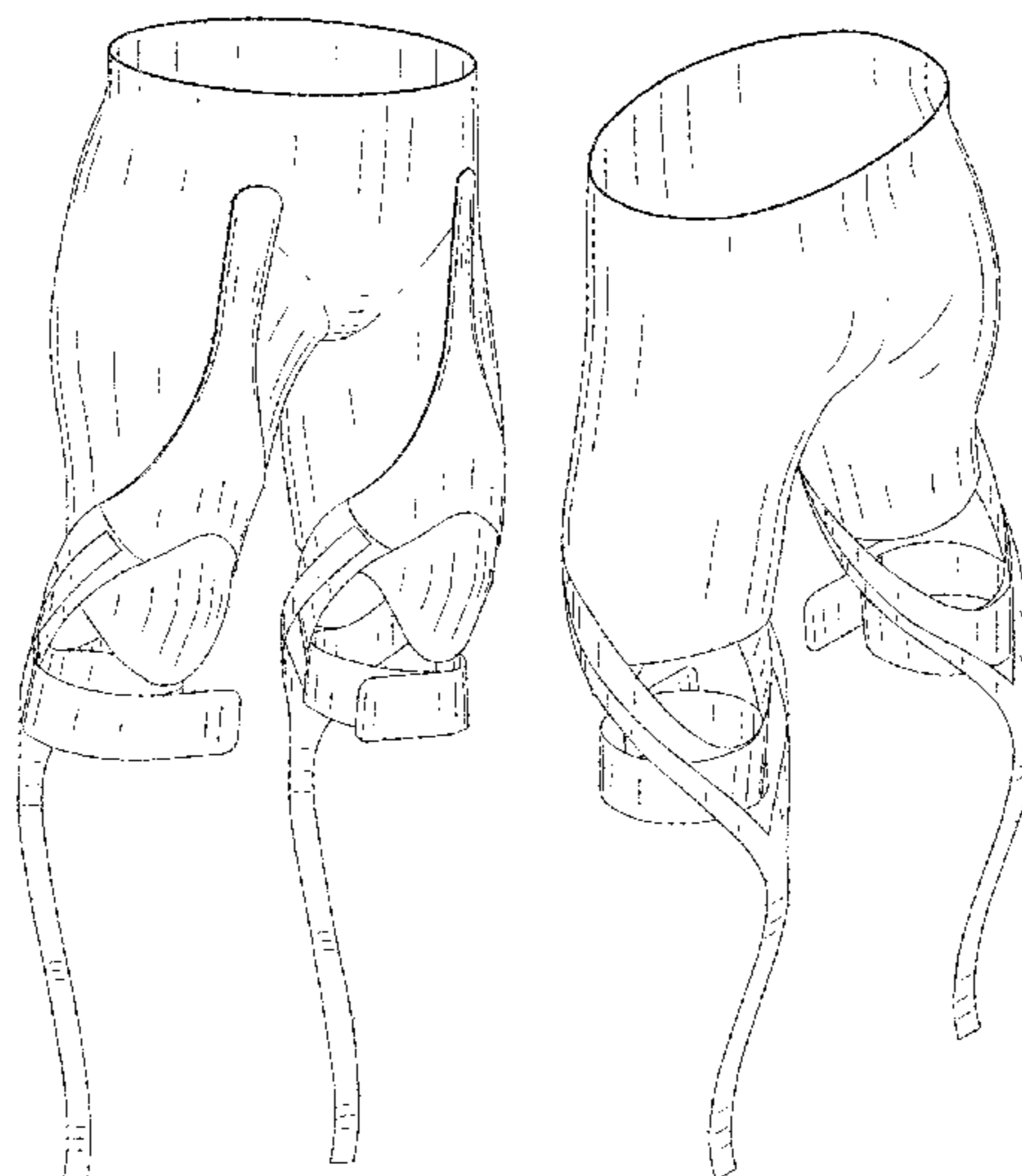

(56)

References Cited

U.S. PATENT DOCUMENTS

D726,925	S *	4/2015	Fraser	D24/190
D735,872	S *	8/2015	Ljubimir	D24/192
D749,227	S *	2/2016	Takama	D15/199
2004/0024340	A1 *	2/2004	Schwenn	A61F 5/0125 602/62
2004/0116260	A1 *	6/2004	Drennan	A61F 5/0193 482/124
2011/0000005	A1 *	1/2011	Brown	A61F 5/0104 2/227
2013/0012852	A1 *	1/2013	Imaida	A61F 5/01 602/16

* cited by examiner

FIG. 1

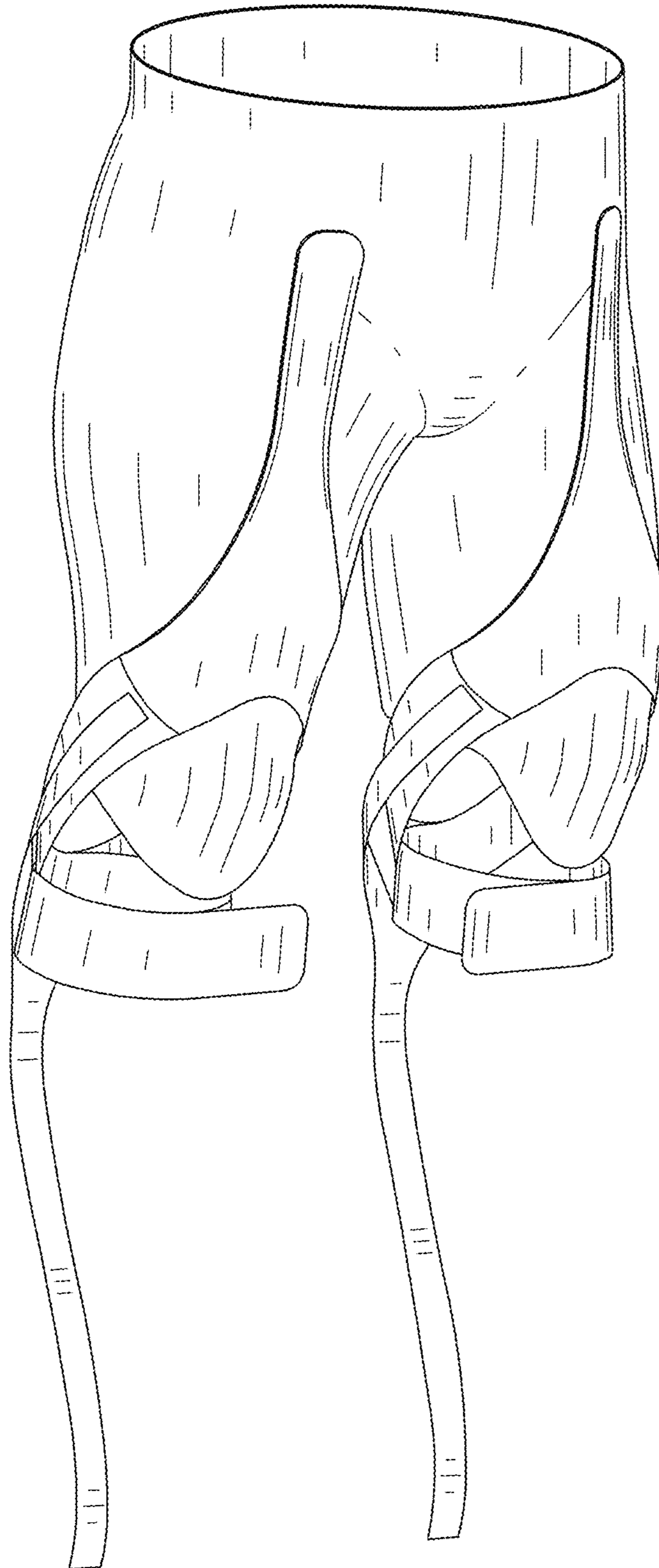

FIG. 2

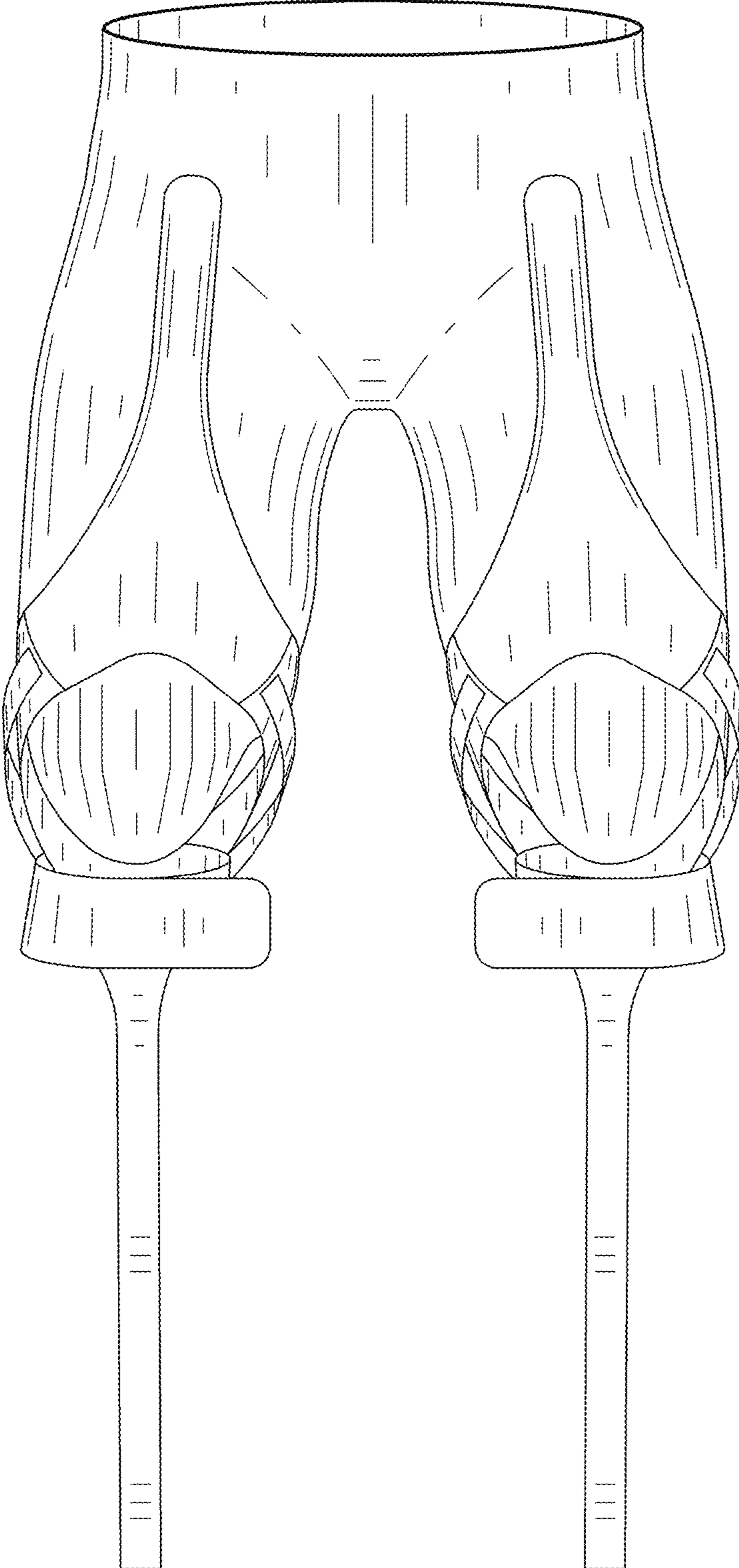

FIG. 3

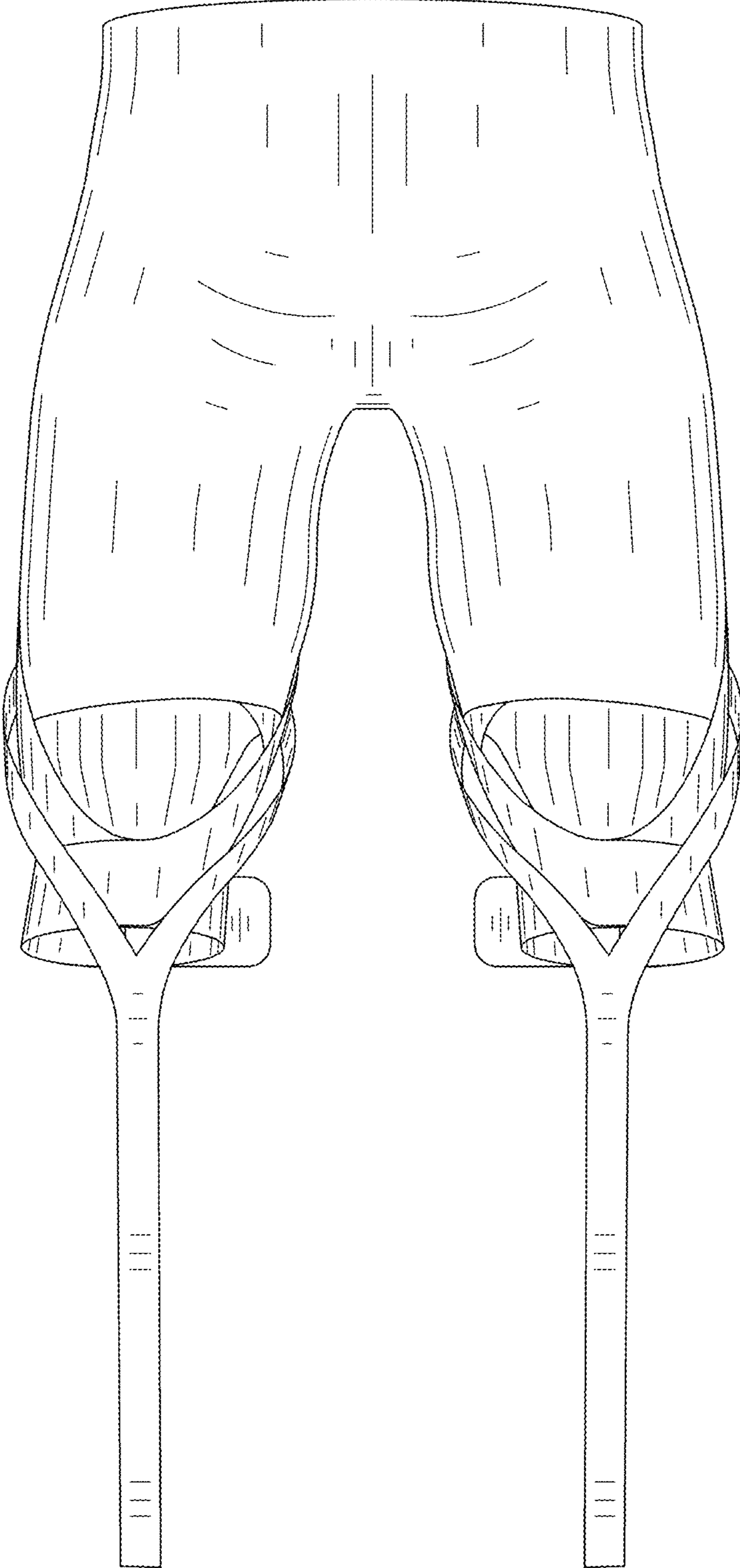

FIG. 4

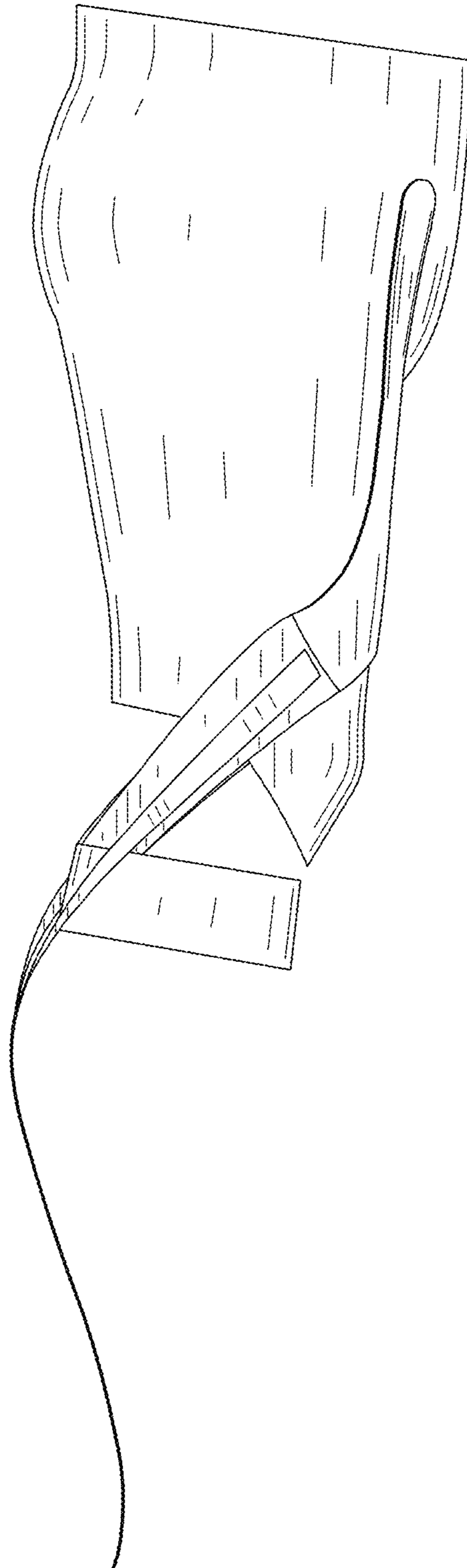

FIG. 5

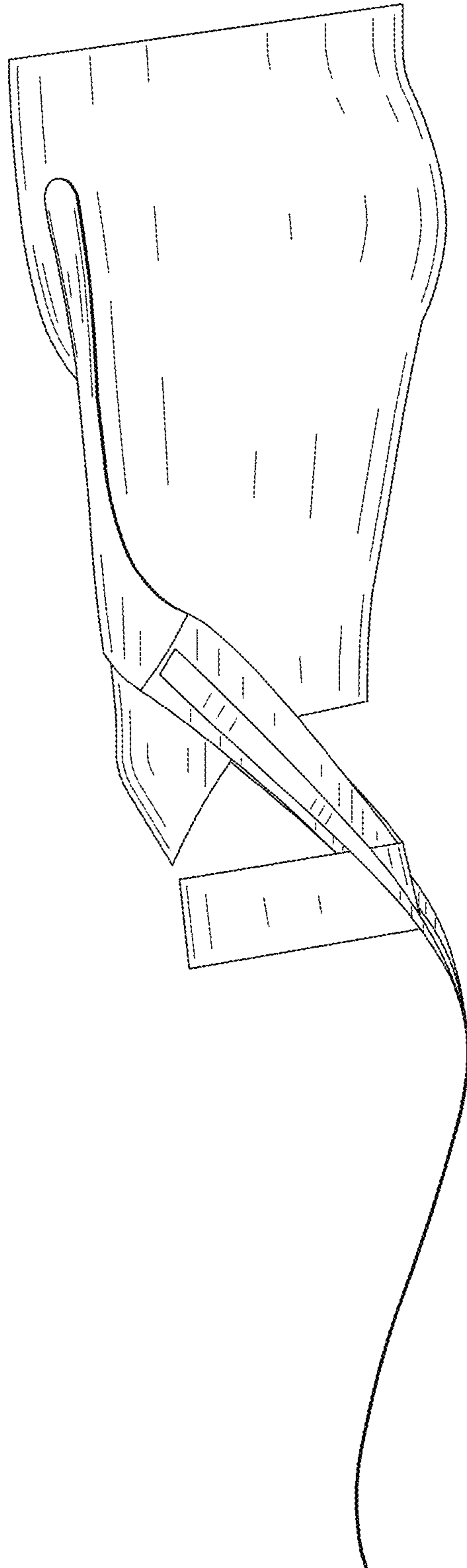

FIG. 6

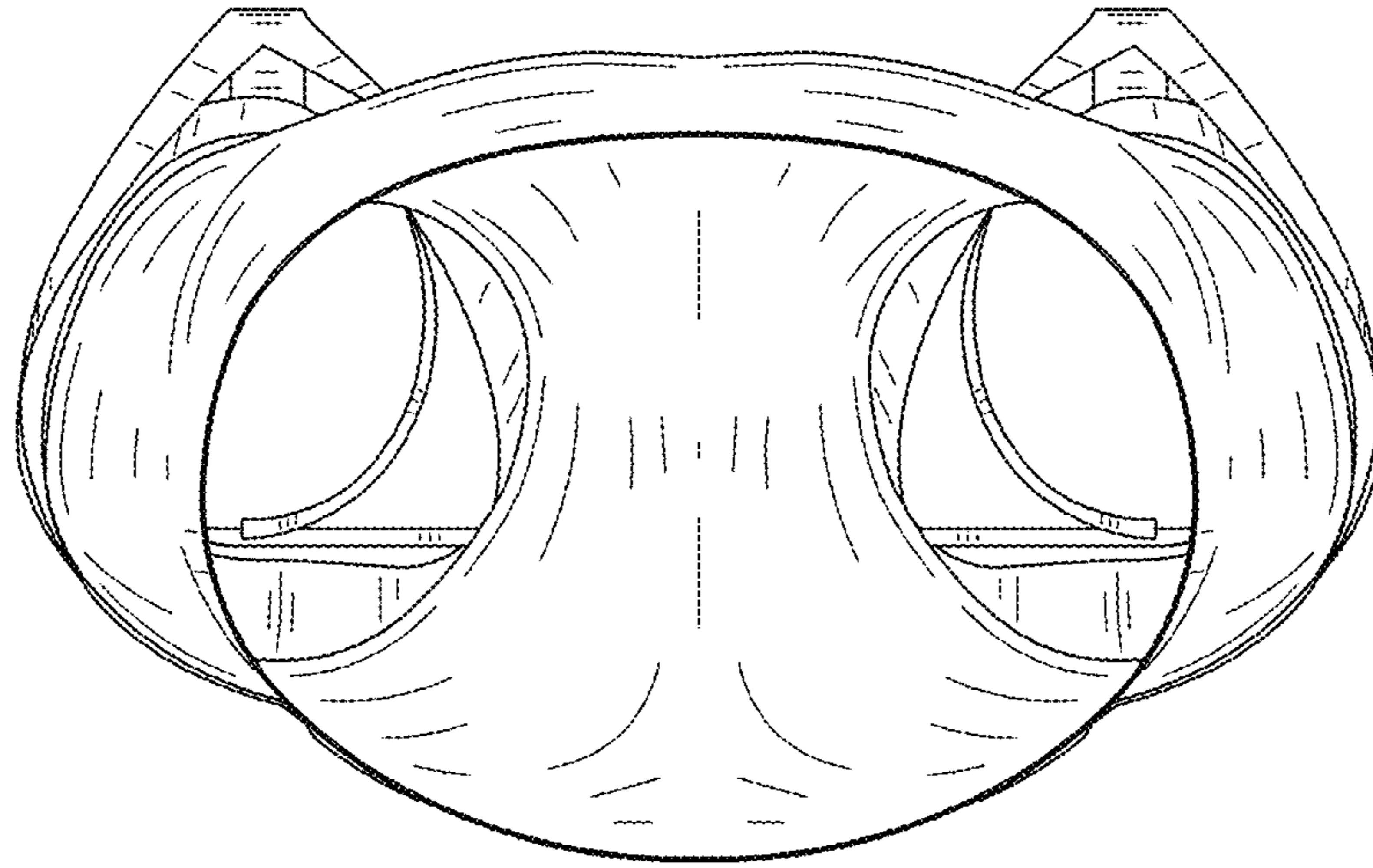

FIG. 7

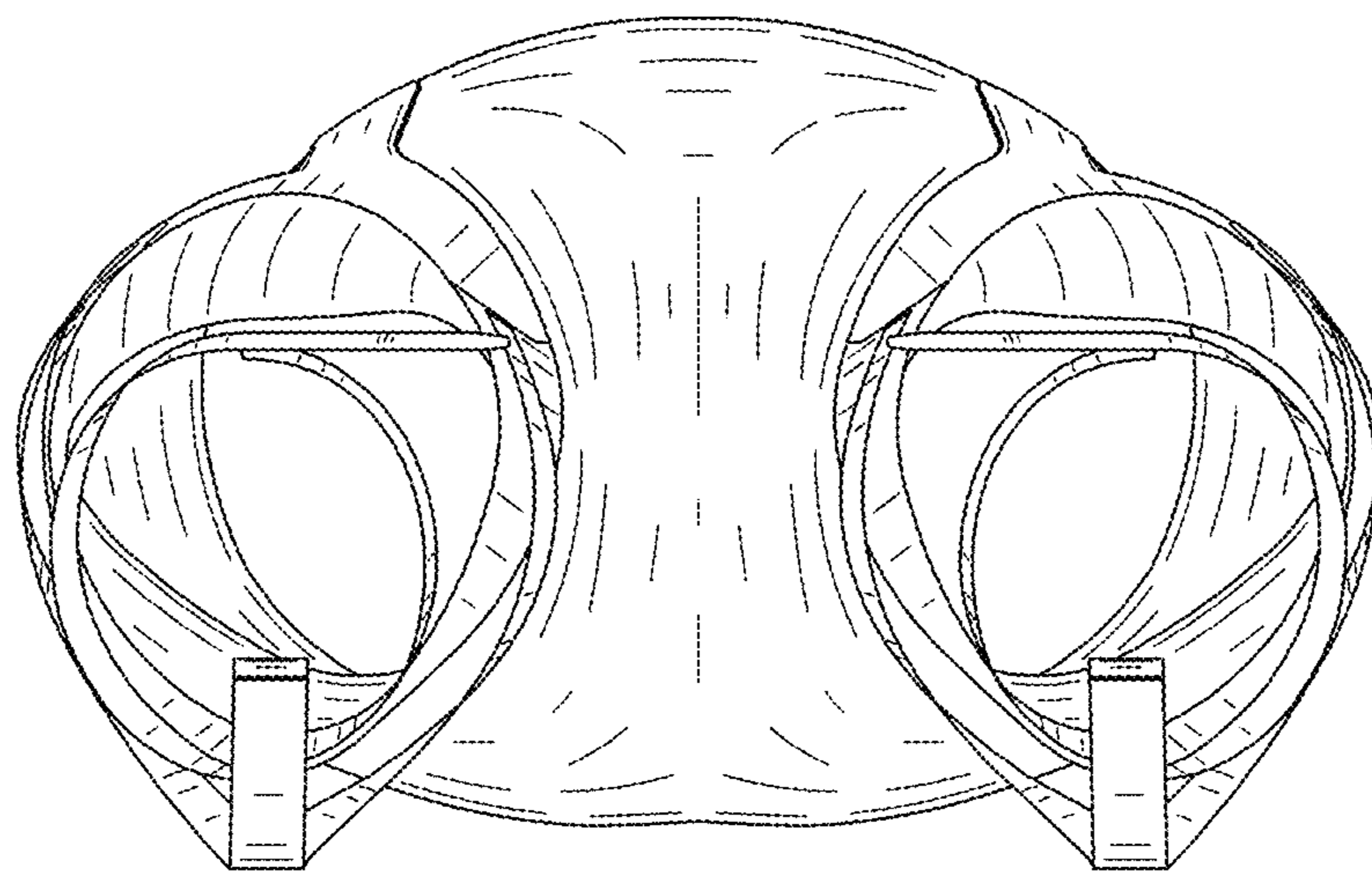

FIG. 8

