



US00D785175S

(12) **United States Design Patent** (10) **Patent No.:** **US D785,175 S**  
**Zhou et al.** (45) **Date of Patent:** **\*\* Apr. 25, 2017**

(54) **TROCAR NEEDLE**  
(71) Applicant: **Guangzhou T.K Medical Instrument Co., Ltd.**, Guangzhou (CN)  
(72) Inventors: **Xing Zhou**, Guangzhou (CN); **Shaoming Zhu**, Guangzhou (CN); **Linhai Liu**, Guangzhou (CN); **Jiajiang Wei**, Guangzhou (CN); **Huaping Xu**, Guangzhou (CN); **Lifei Luo**, Guangzhou (CN)

(73) Assignee: **GUANGZHOU T. K. MEDICAL INSTRUMENT CO., LTD.**, Guangzhou (CN)

(\*\*) Term: **15 Years**

(21) Appl. No.: **29/528,986**

(22) Filed: **Jun. 2, 2015**

(30) **Foreign Application Priority Data**

Mar. 19, 2015 (CN) ..... 2015 3 0067286  
Mar. 19, 2015 (CN) ..... 2015 3 0067313

(51) **LOC (10) Cl.** ..... **24-02**

(52) **U.S. Cl.**  
USPC ..... **D24/146**

(58) **Field of Classification Search**  
USPC ..... D7/649; D8/93, 97, 300, 310, 311, 313; D19/110, 115; D24/146, 147, 148  
See application file for complete search history.

(56) **References Cited**

**U.S. PATENT DOCUMENTS**

D541,417 S \* 4/2007 Albrecht ..... D24/146  
D542,918 S \* 5/2007 Albrecht ..... D24/146  
8,206,411 B2 \* 6/2012 Thompson ..... A61B 17/3462  
600/184

D667,554 S \* 9/2012 Casabonne ..... D24/117  
D753,303 S \* 4/2016 Dannaher ..... D24/146  
2004/0230161 A1 \* 11/2004 Zeiner ..... A61B 17/34  
604/167.06  
2004/0260244 A1 \* 12/2004 Piechowicz ..... A61B 17/34  
604/167.06  
2005/0070946 A1 \* 3/2005 Franer ..... A61B 17/3498  
606/185  
2006/0264992 A1 \* 11/2006 Franer ..... A61B 17/3462  
606/167  
2007/0066988 A1 \* 3/2007 Datta ..... A61B 17/3417  
606/185

(Continued)

**OTHER PUBLICATIONS**

Guangzhou, Certificate of Registration HK1501161.8 (M001), Oct. 2, 2015, 8 pgs.

(Continued)

*Primary Examiner* — Ian Simmons  
*Assistant Examiner* — Samantha Q Lawrence  
(74) *Attorney, Agent, or Firm* — Morgan, Lewis & Bockius LLP

(57) **CLAIM**

The ornamental design for a trocar needle, as shown and described.

**DESCRIPTION**

FIG. 1 is a perspective view of a trocar needle; FIG. 2 is a first side view of the design of FIG. 1; FIG. 3 is a second side view of the design of FIG. 1; FIG. 4 is a third side view of the design of FIG. 1; FIG. 5 is a fourth side view of the design of FIG. 1; FIG. 6 is a top view of the design of FIG. 1; and, FIG. 7 is a bottom view of the design of FIG. 1. The broken lines shown in the drawings represent portions of the trocar needle that form no part of the claimed design.

**1 Claim, 6 Drawing Sheets**

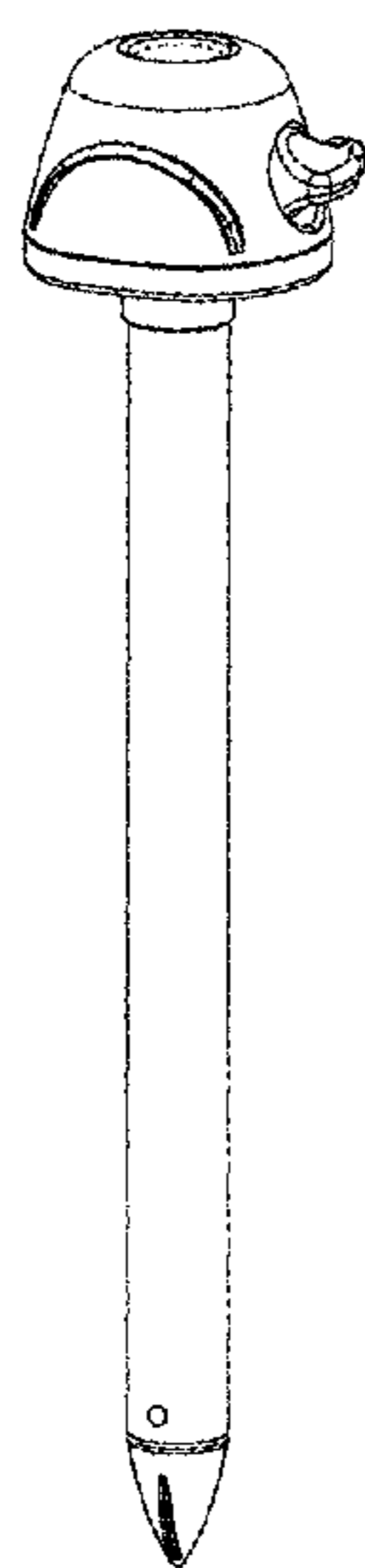

(56)

**References Cited**

U.S. PATENT DOCUMENTS

2007/0185453 A1\* 8/2007 Michael ..... A61B 17/3462  
604/164.01  
2007/0260273 A1\* 11/2007 Cropper ..... A61B 1/00087  
606/185  
2008/0228214 A1\* 9/2008 Hoan ..... A61B 17/34  
606/185  
2009/0270817 A1\* 10/2009 Moreno ..... A61B 17/3462  
604/264  
2011/0046449 A1\* 2/2011 Minnelli ..... A61B 1/00128  
600/205  
2013/0338694 A1\* 12/2013 Fischvogt ..... A61B 17/3494  
606/185

OTHER PUBLICATIONS

Guangzhou, Certificate of Registration HK1501161.8 (M002), Oct. 2, 2015, 8 pgs.  
Guangzhou, Office Action, CA163513. Nov. 24, 2015, 3 pgs.  
Guangzhou, Notice of Allowance TW104302974, Jun. 22, 2016, 2 pgs.  
Guangzhou, Decision of a Design Registration, (Decision to Allow), KR30-2015-0047413, Design No. M001, Mar. 7, 2016, 3 pgs.  
Guangzhou, Notice to file a Response, KR30-2015-0047413, Design No. M002, Feb. 7, 2016, 3 pgs.  
Guangzhou, Patent Certificate, TW104302974, Aug. 11, 2016, 2 pgs.  
Guangzhou, Certificate of Registration, CA 163513. Nov. 16, 2016, 2 pgs.  
Guangzhou, Decision of a Design Registration, (Decision to Allow), KR30-2015-0047413, Design No. M002, Nov. 10, 2016, 3 pgs.  
Guangzhou, Notice of Allowance, TW104302974D01, Nov. 25, 2016, 2 pgs.

\* cited by examiner

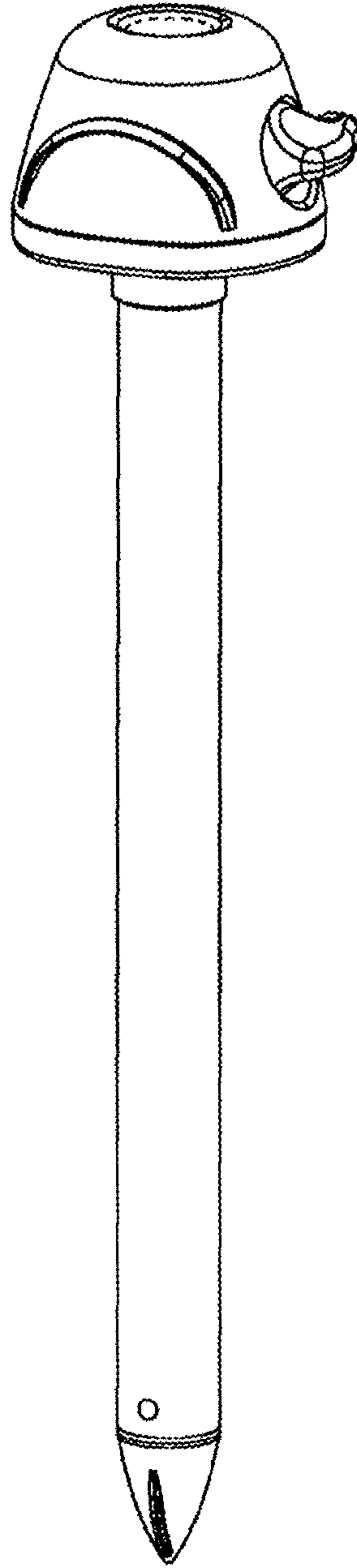

FIG. 1

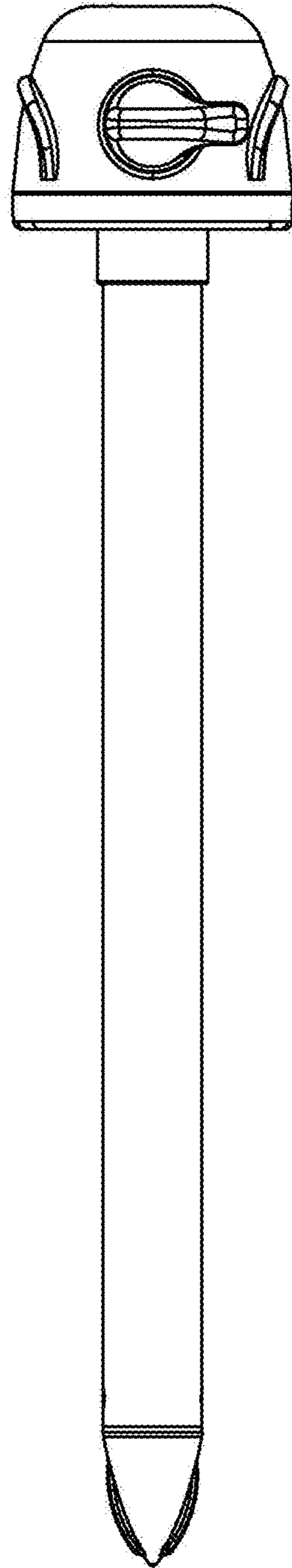

FIG. 2

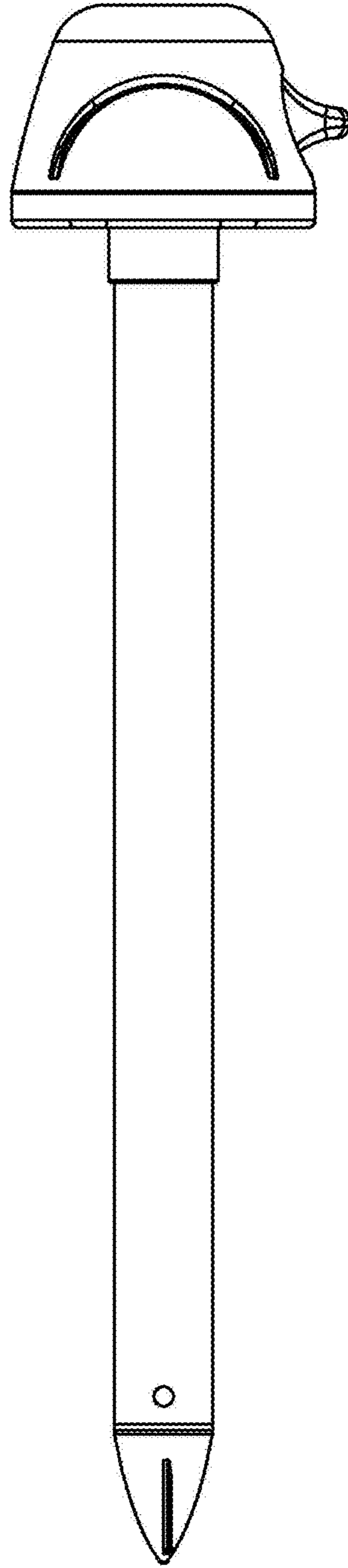

FIG. 3

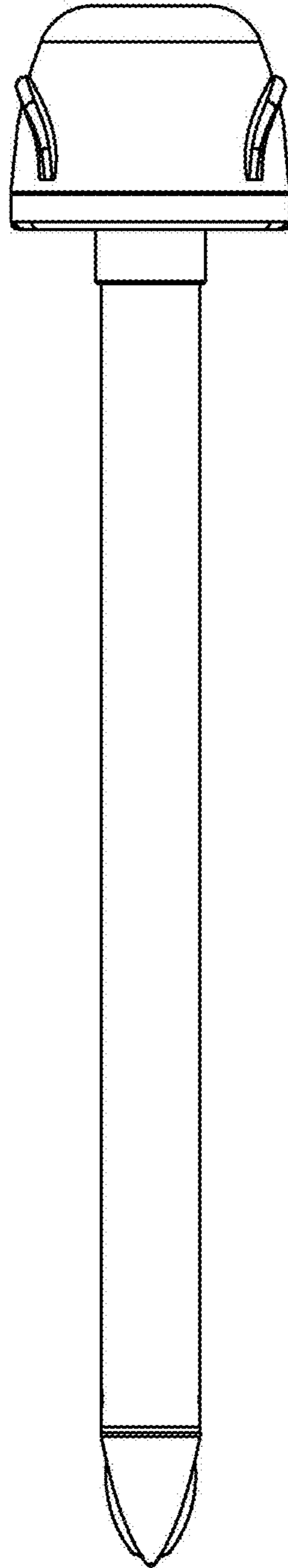

FIG. 4

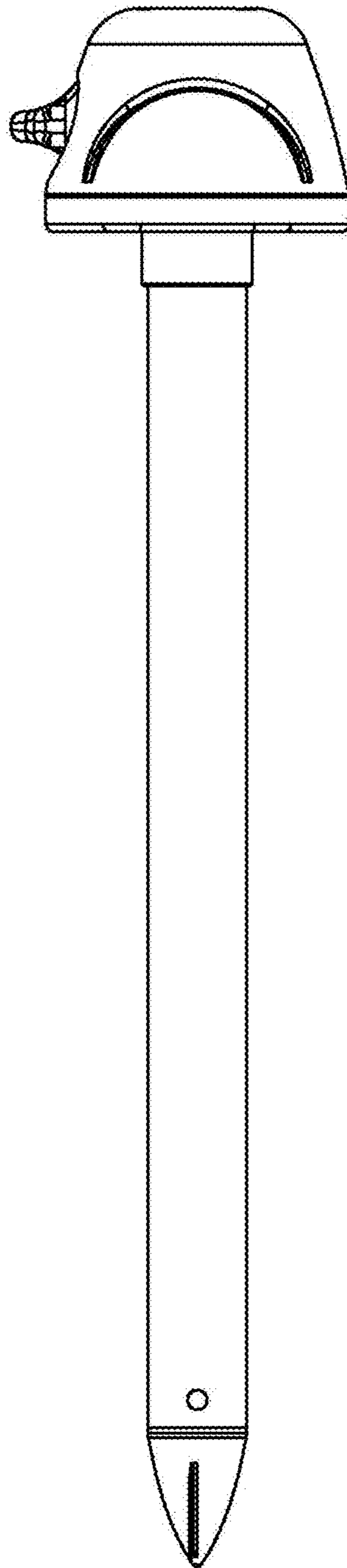

FIG. 5

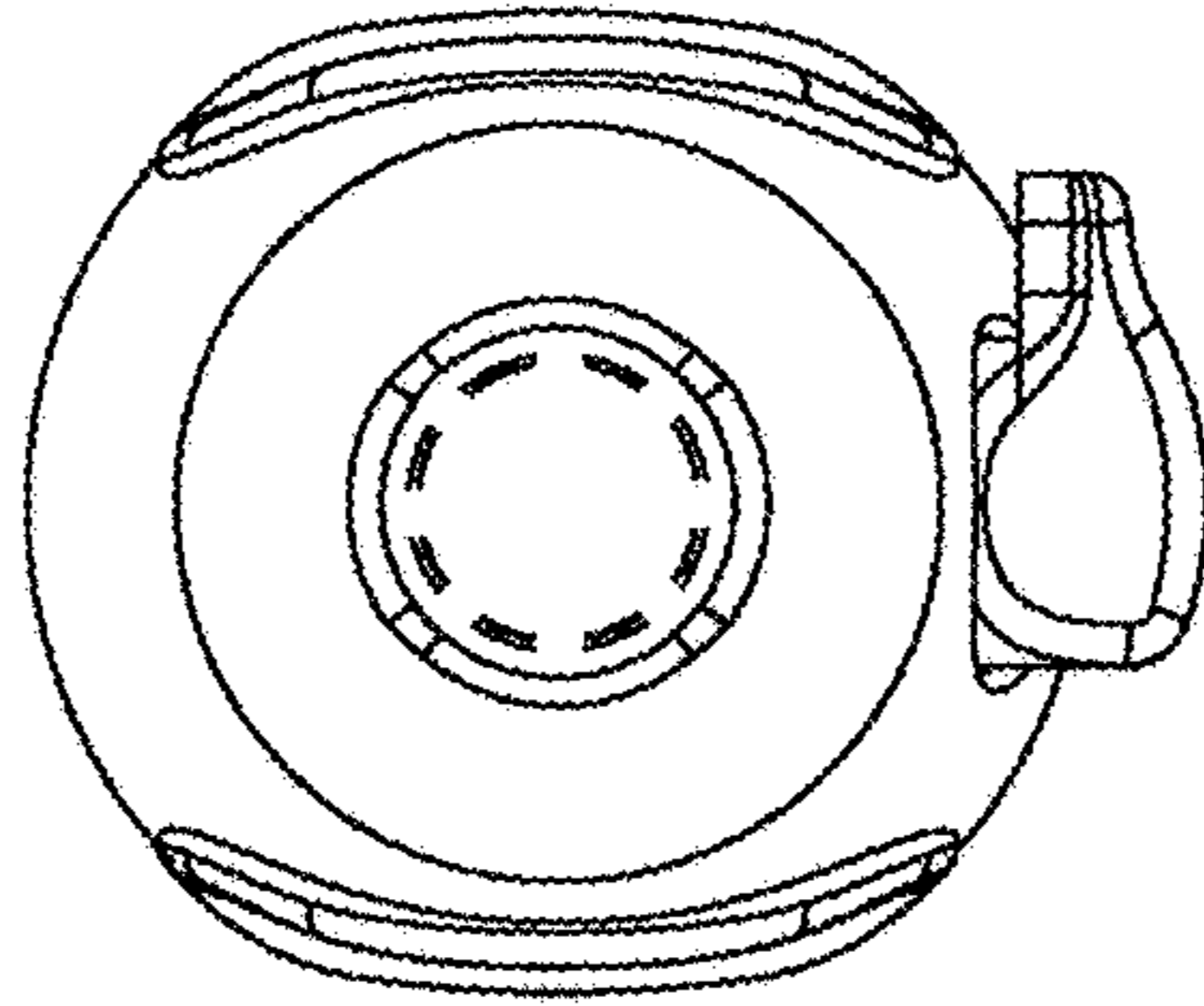

FIG. 6

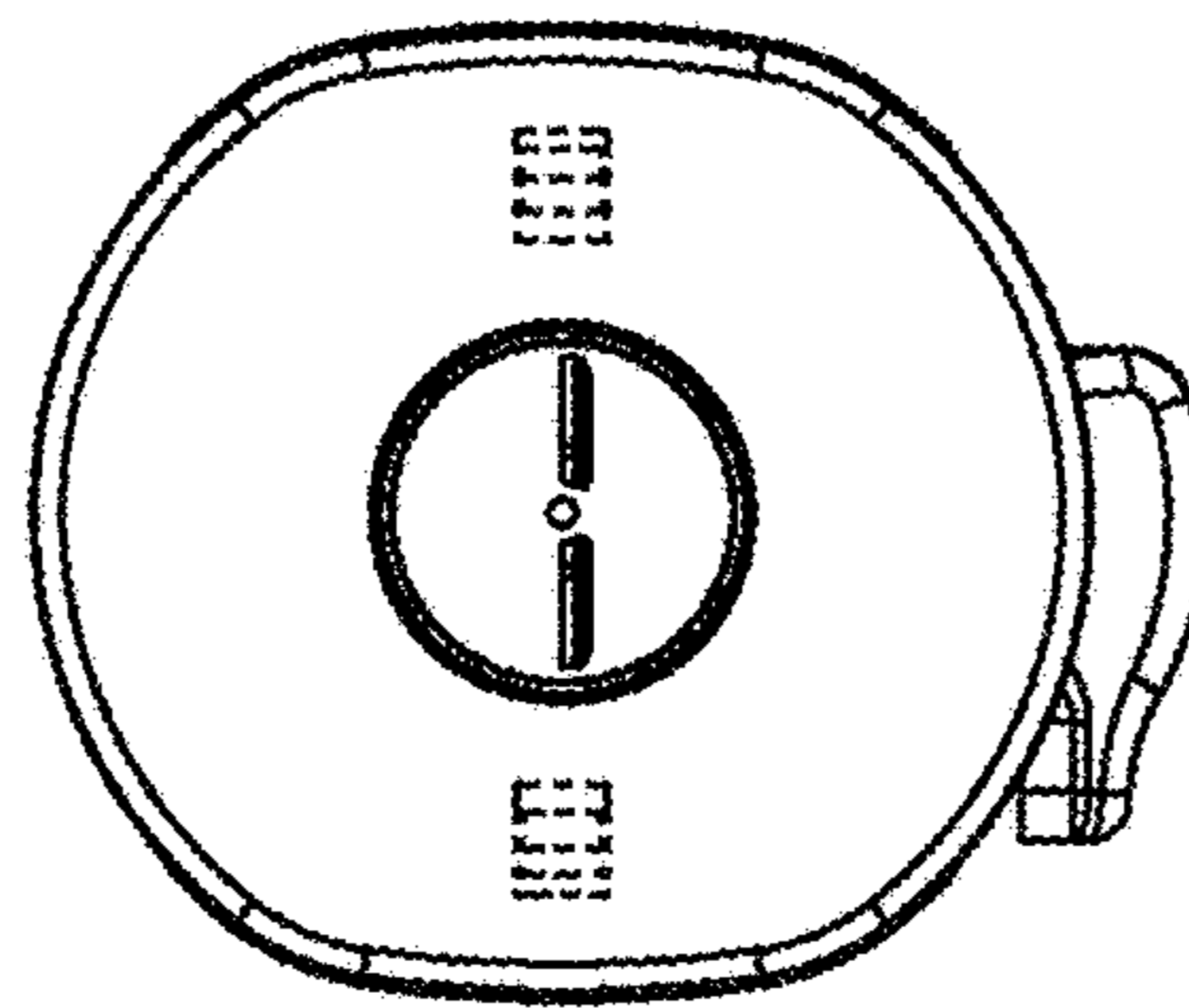

FIG. 7