



US00D785173S

(12) **United States Design Patent** (10) **Patent No.:** **US D785,173 S**
Oberkircher et al. (45) **Date of Patent:** **** Apr. 25, 2017**

(54) **HANDLE FOR LAPAROSCOPIC SURGERY INSTRUMENTS**

(71) Applicant: **Ethicon Endo-Surgery, LLC**,
Guaynabo, PR (US)

(72) Inventors: **Brendan J. Oberkircher**, Cincinnati,
OH (US); **Cory G. Kimball**, Hamilton,
OH (US); **Bryce Hansen**, Idaho Falls,
ID (US)

(73) Assignee: **Ethicon Endo-Surgery, LLC**,
Guaynabo, PR (US)

(**) Term: **15 Years**

(21) Appl. No.: **29/530,423**

(22) Filed: **Jun. 16, 2015**

(51) **LOC (10) Cl.** **24-02**

(52) **U.S. Cl.**
USPC **D24/138**

(58) **Field of Classification Search**
USPC D24/108, 112, 117, 118, 130, 133, 135,
D24/137, 138, 222, 141, 111, 113, 127,
D24/143, 144, 148, 179, 216, 152, 153,
D24/154, 176, 170

CPC A61B 1/00; A61B 1/00137; A61B 1/005;
A61B 1/0014; A61B 1/0676; A61B
1/0669; A61B 1/00121; A61B 1/00133;
A61B 1/00071; A61B 1/00064; A61B
1/00068; A61B 1/00112; A61B 1/0125;
A61B 17/3478

See application file for complete search history.

(56) **References Cited**

U.S. PATENT DOCUMENTS

5,224,954 A * 7/1993 Watts A61B 17/0218
606/205
5,330,502 A * 7/1994 Hassler A61B 17/29
600/564

7,156,846 B2 * 1/2007 Dycus A61B 18/00
606/41
8,585,734 B2 * 11/2013 Hallbeck A61B 17/29
606/205
2006/0190027 A1 * 8/2006 Downey A61B 17/29
606/205
2011/0163147 A1 * 7/2011 Laurent A61B 17/072
227/175.2
2012/0116388 A1 * 5/2012 Houser A61B 17/00234
606/41
2013/0324998 A1 * 12/2013 Kimball A61B 17/32006
606/41

* cited by examiner

Primary Examiner — Robert M Spear

Assistant Examiner — Eliza Bennett-Hattan

(57) **CLAIM**

The ornamental design for a handle for laparoscopic surgery instruments, as shown and described.

DESCRIPTION

FIG. 1 is a perspective view of a handle for laparoscopic surgery instruments;
FIG. 2 is a top plan view thereof;
FIG. 3 is a left side elevation view thereof;
FIG. 4 is a bottom plan view thereof;
FIG. 5 is a right side elevation view thereof;
FIG. 6 is a front elevation view thereof; and,
FIG. 7 is an end elevation view thereof.

The broken lines shown in the drawings are included for the purpose of illustrating structural environment and form no part of the claimed design.

1 Claim, 4 Drawing Sheets

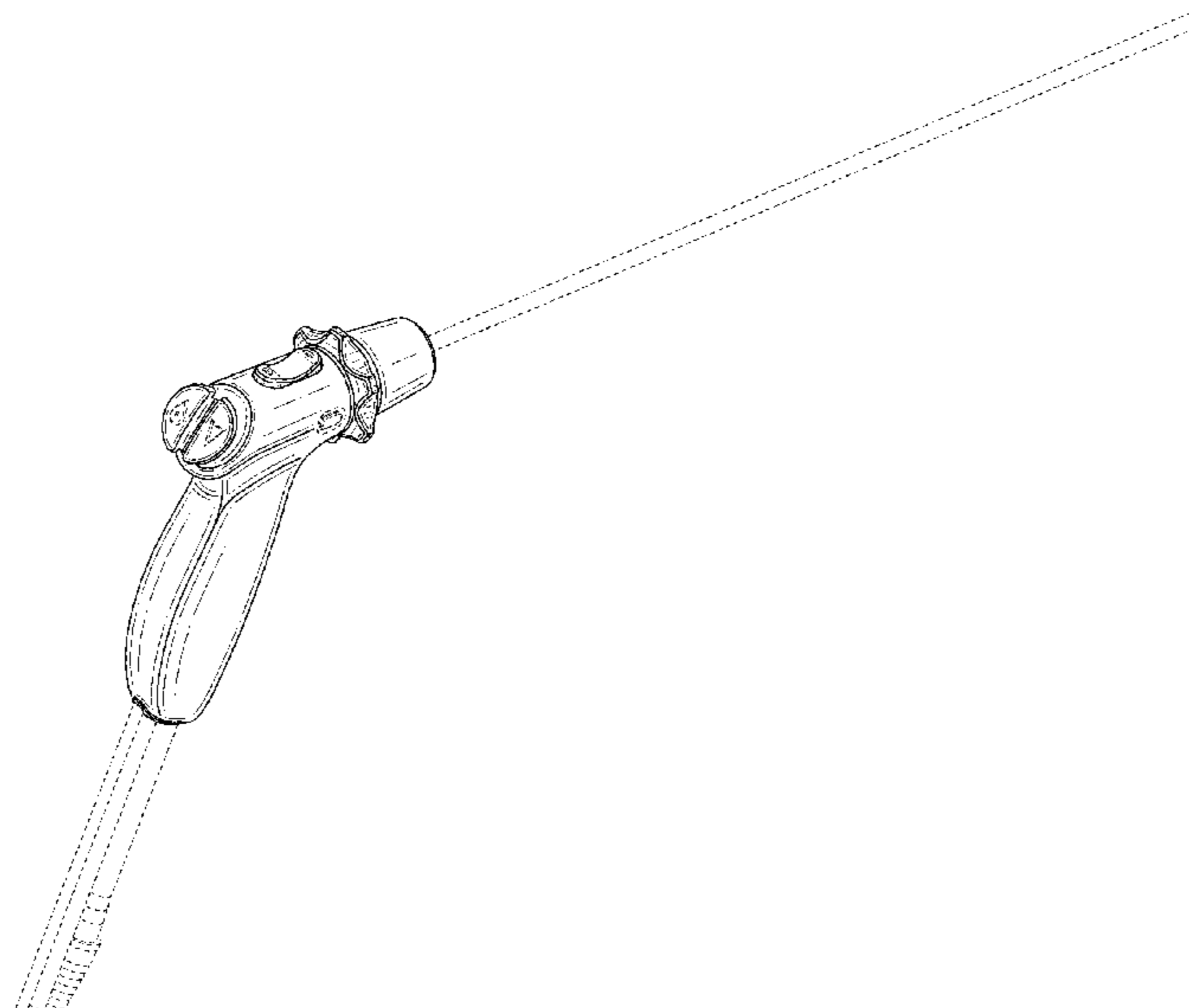

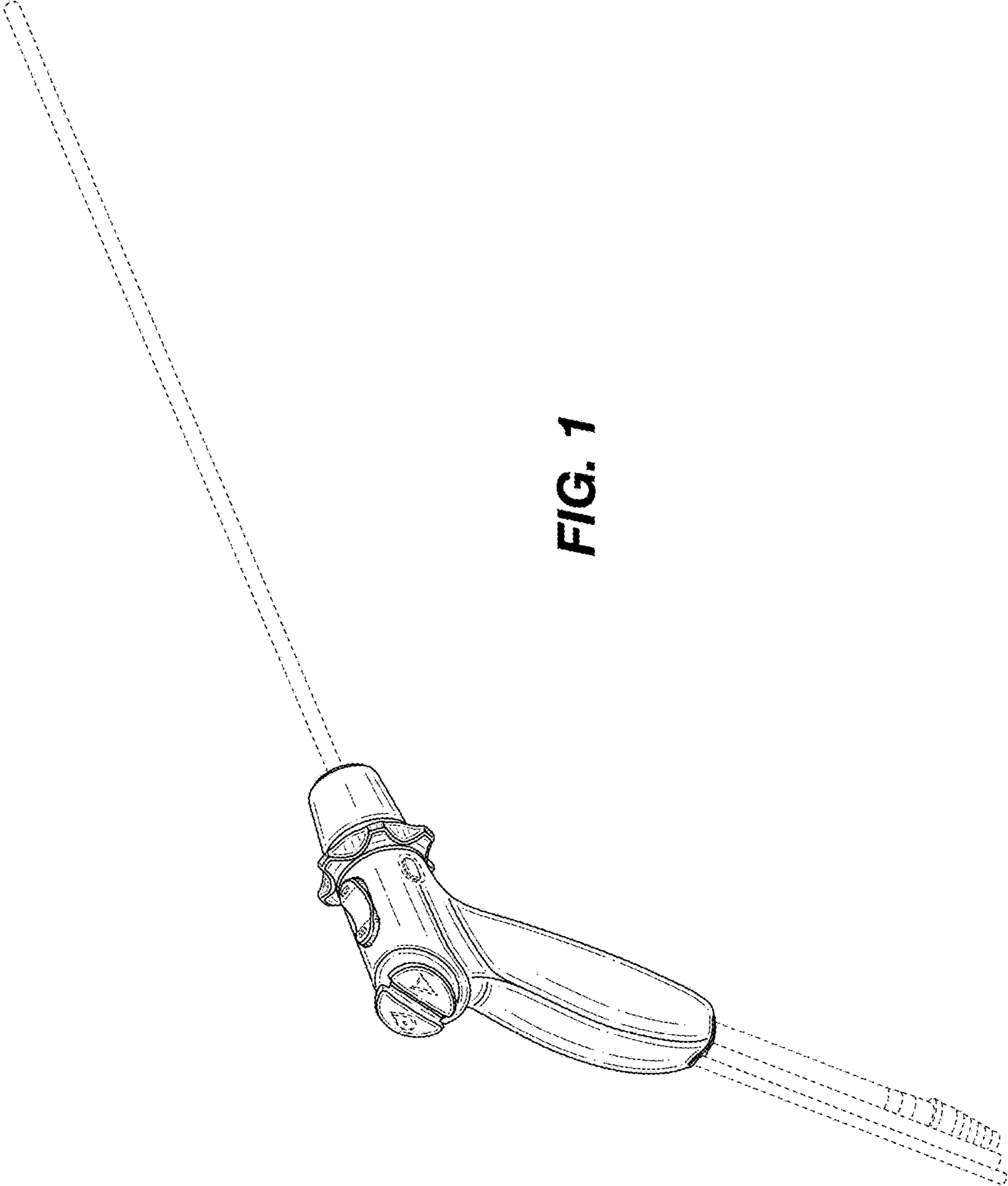

FIG. 1

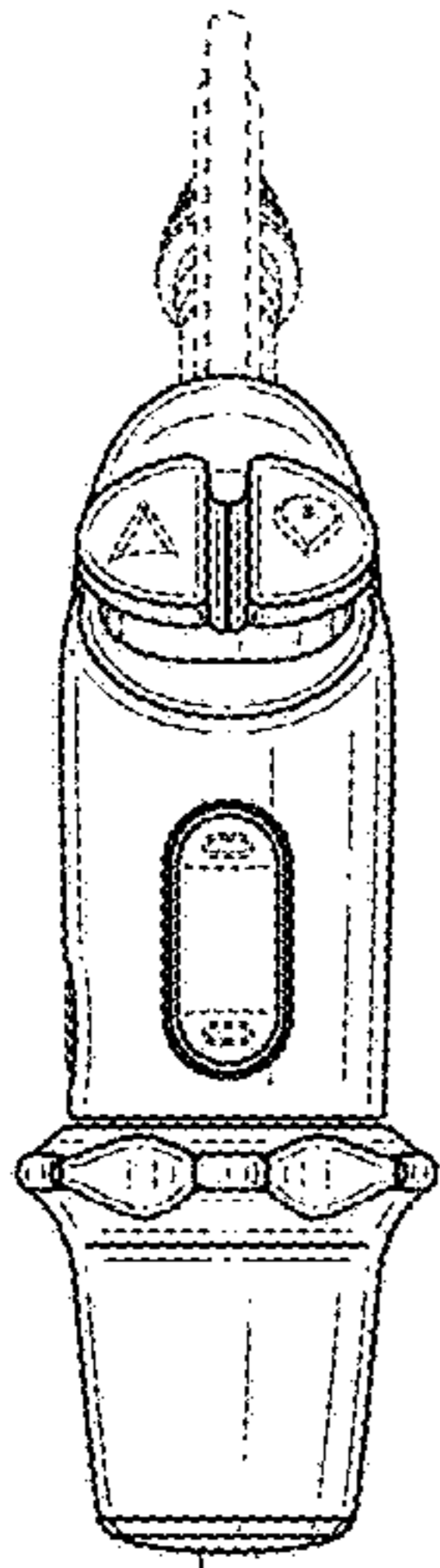

FIG. 2

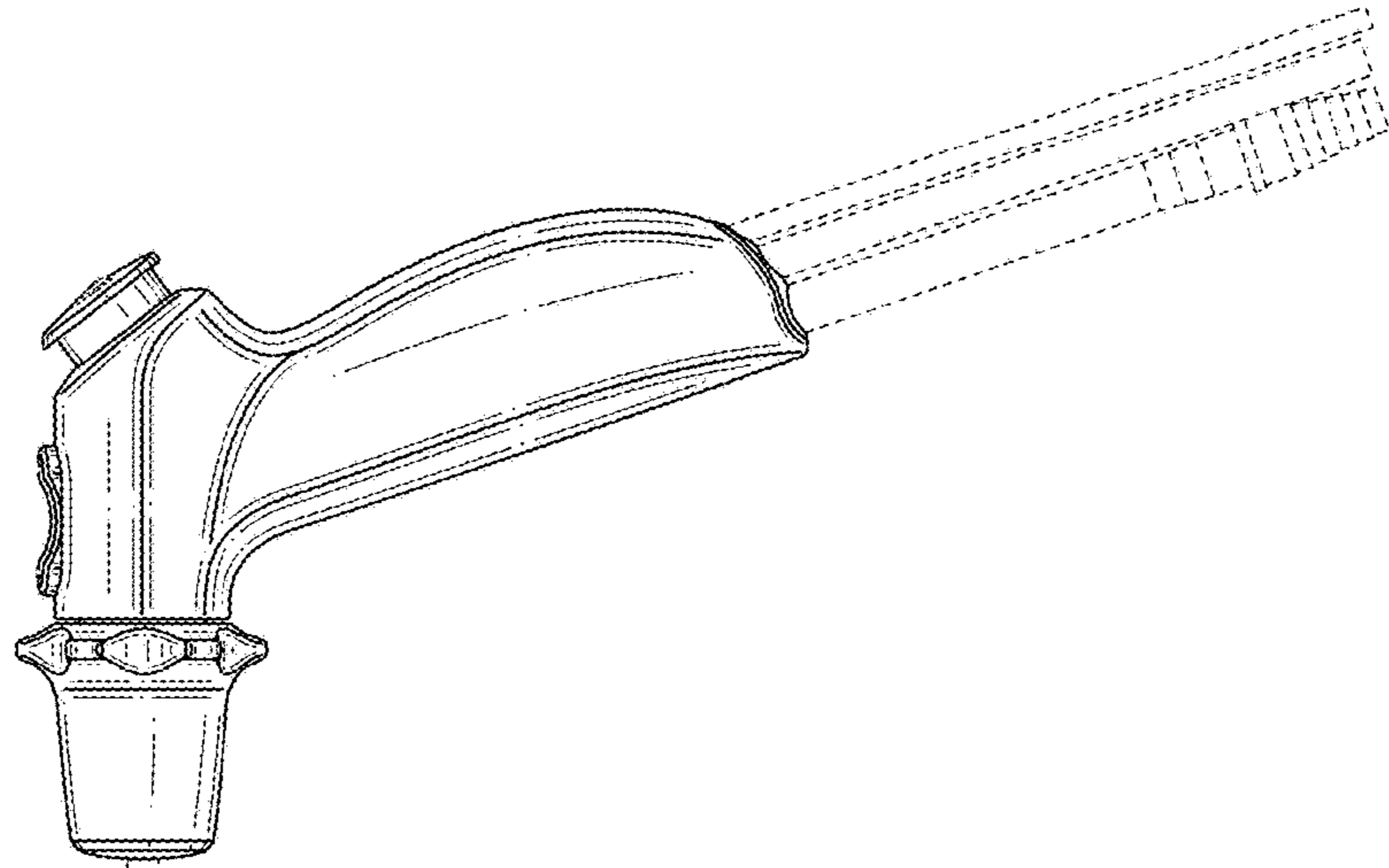

FIG. 3

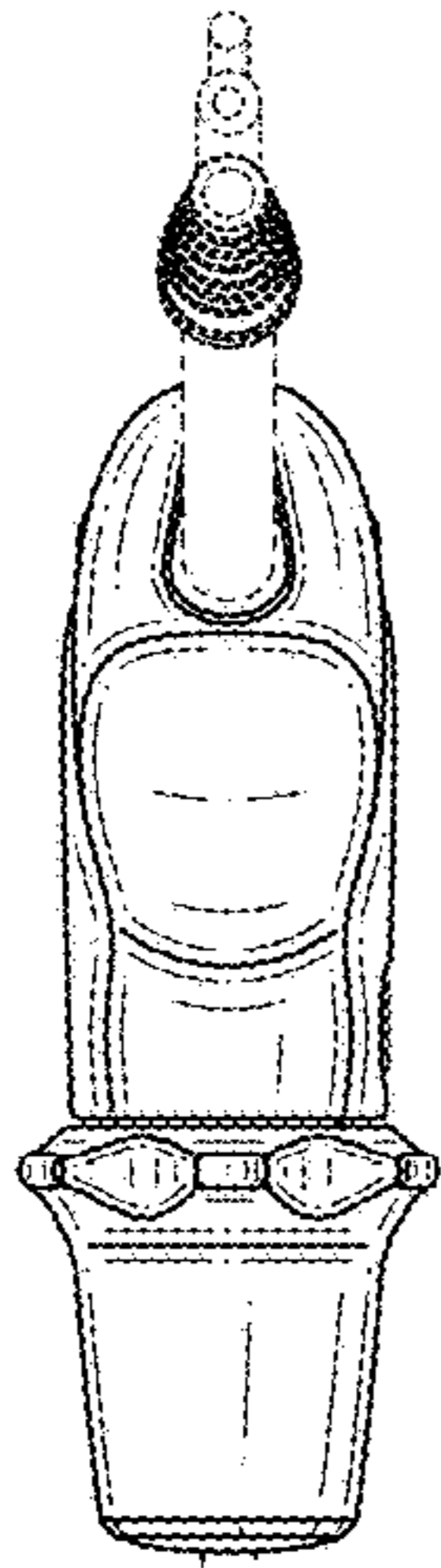

FIG. 4

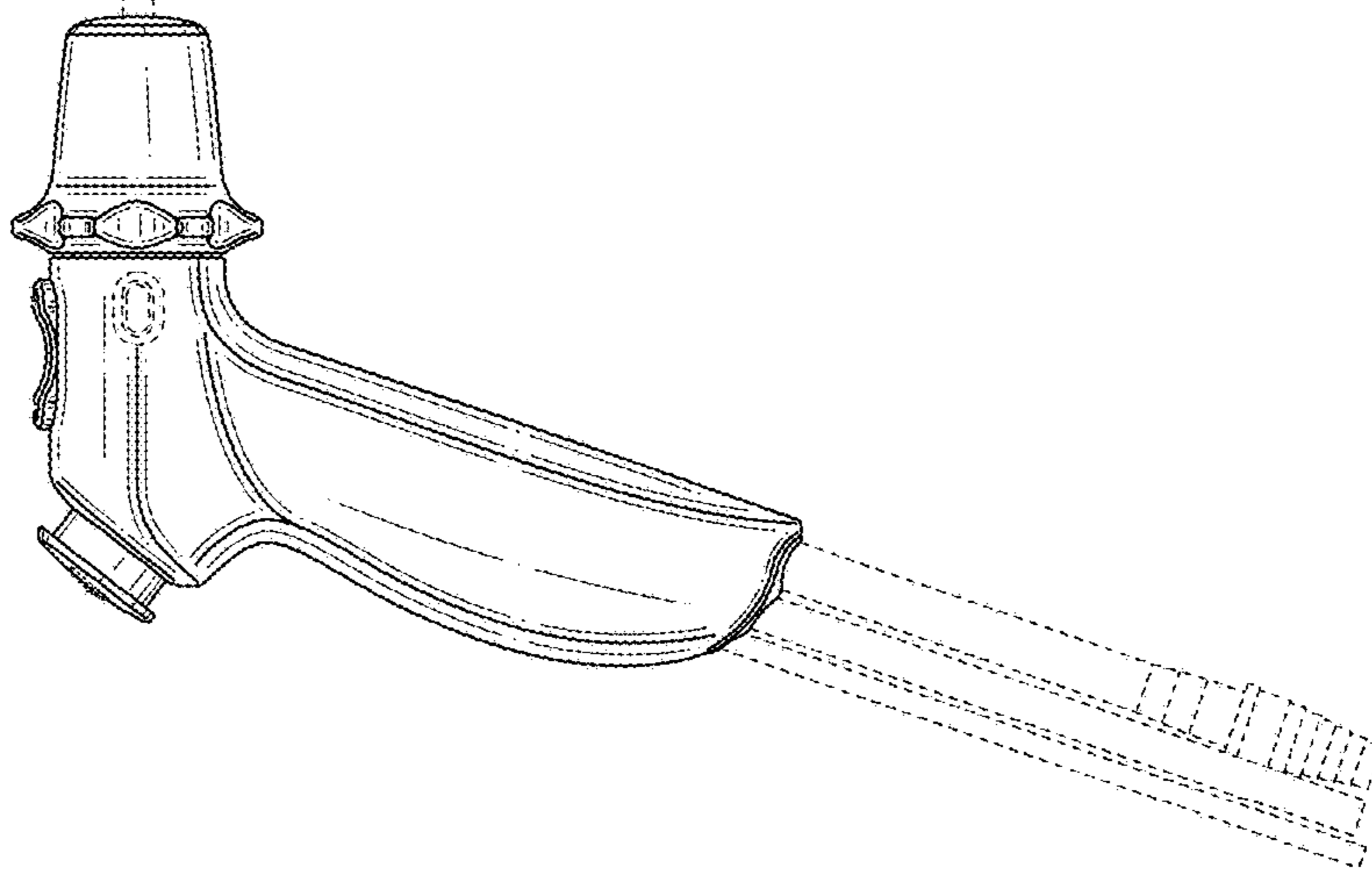

FIG. 5

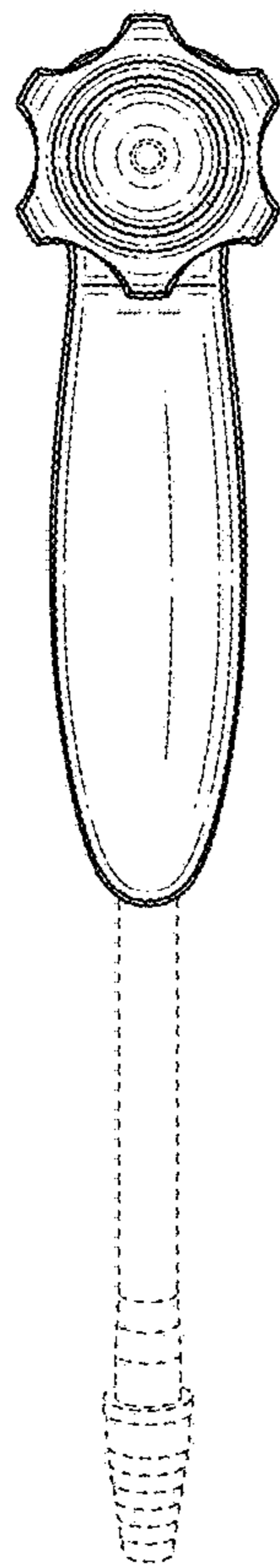

FIG. 6

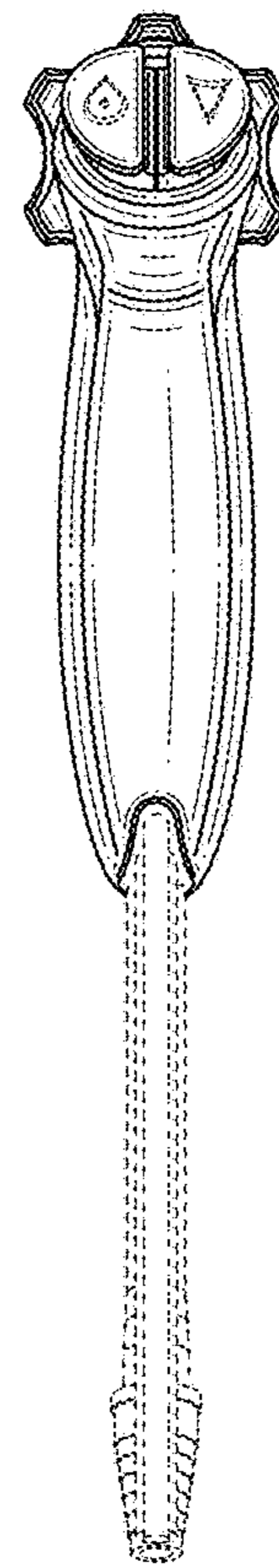

FIG. 7