



US00D785171S

(12) **United States Design Patent**
Roeloffs

(10) **Patent No.:** **US D785,171 S**
(45) **Date of Patent:** **** Apr. 25, 2017**

(54) **SPECULUM**

- (71) Applicant: **Bridea IP Limited**, Hong Kong (HK)
- (72) Inventor: **Bob Roeloffs**, Amsterdam (NL)
- (73) Assignee: **Bridea IP Limited**, Hong Kong (HK)
- (**) Term: **15 Years**
- (21) Appl. No.: **29/548,949**
- (22) Filed: **Dec. 17, 2015**
- (51) **LOC (10) Cl.** **24-02**
- (52) **U.S. Cl.**
USPC **D24/135; D24/133**
- (58) **Field of Classification Search**
USPC D24/135, 231, 133, 137, 112
CPC A61B 1/32; A61B 17/42; A61B 1/00154;
A61B 1/00147; A61B 1/303; A61B
1/00087; A61B 5/4306; A61B 1/0008
See application file for complete search history.

(56) **References Cited**

U.S. PATENT DOCUMENTS

- 2,320,709 A * 6/1943 Arnesen A61B 1/32
600/221
- D299,532 S * 1/1989 Cecil, Jr. D24/135
- 5,007,409 A * 4/1991 Pope A61B 1/32
600/203

(Continued)

FOREIGN PATENT DOCUMENTS

- CN 3622025 * 3/2007
- CN 302342871 * 6/2013

(Continued)

OTHER PUBLICATIONS

Orchid Spec, announced May 17, 2013 [online], [site visited Nov. 17, 2016]. Available from internet, URL: <http://bridea.com.hk/>.*
(Continued)

Primary Examiner — Keli L Hill

Assistant Examiner — Karra S Johnson

(74) *Attorney, Agent, or Firm* — Fross Zelnick Lehrman & Zissu P.C.; Charles T.J. Weigell Esq.; Larry E. Apoizon Esq.

(57) **CLAIM**

The ornamental design for a speculum, as shown and described.

DESCRIPTION

FIG. 1 is a front perspective view of a bag showing my new design;
 FIG. 2 is a bottom view thereof;
 FIG. 3 is a rear left perspective view thereof;
 FIG. 4 is a rear view thereof;
 FIG. 5 is a front view thereof;
 FIG. 6 is a left side view thereof;
 FIG. 7 is a bottom rear perspective view with the speculum closed;
 FIG. 8 is a top view thereof;
 FIG. 9 is bottom front perspective view thereof;
 FIG. 10 is the right side view thereof;
 FIG. 11 is rear right perspective view thereof;
 FIG. 12 is a top front perspective view thereof;
 FIG. 13 is a bottom right perspective view thereof; and,
 FIG. 14 is a another left perspective view thereof.
 The wire frame lines shown throughout the views are intended to indicate surface contour and are not intended to be surface ornamentation.

1 Claim, 14 Drawing Sheets

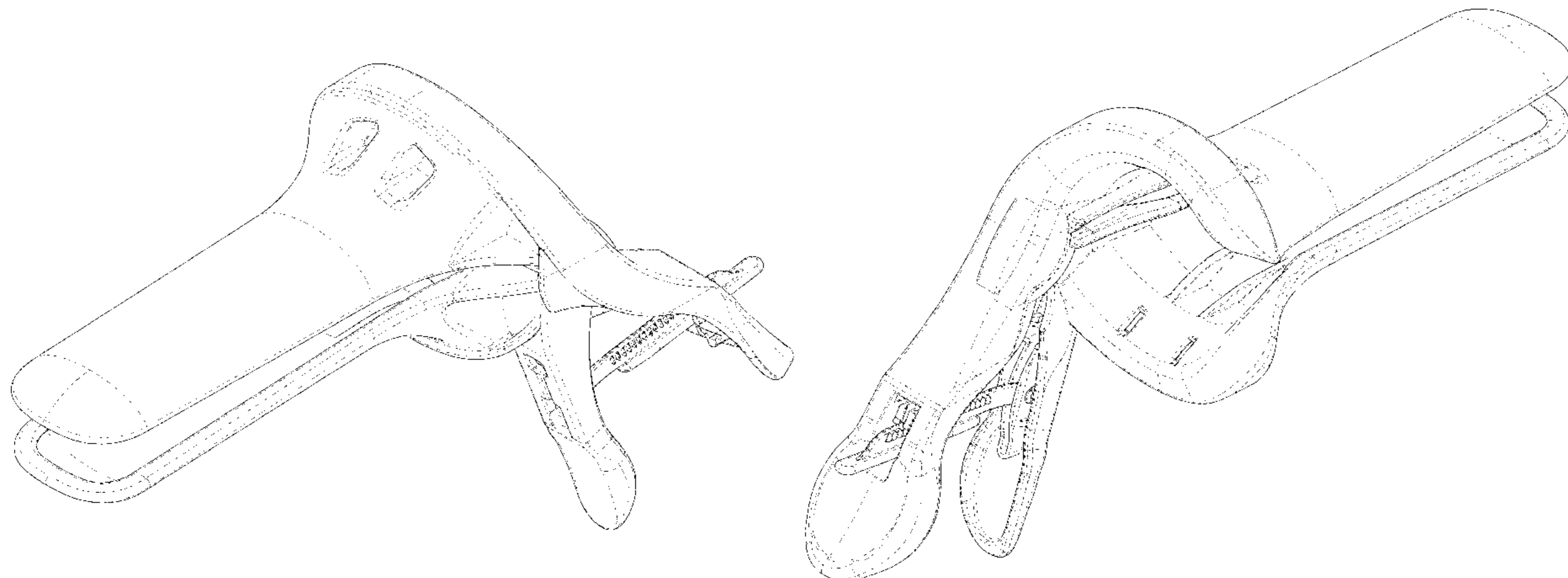

(56)

References Cited

U.S. PATENT DOCUMENTS

5,063,908 A * 11/1991 Collins A61B 1/32
 128/DIG. 26
 5,460,165 A * 10/1995 Mayes A61B 1/32
 600/186
 D558,344 S * 12/2007 Saddlemire D24/135
 D578,646 S * 10/2008 Tsai D24/135
 D710,500 S * 8/2014 Roeloffs D24/135
 2003/0176772 A1 * 9/2003 Yang A61B 1/0669
 600/220
 2009/0275803 A1 * 11/2009 Krauter A61B 1/303
 600/222
 2009/0312610 A1 * 12/2009 Buchok A61B 1/00137
 600/205
 2014/0309499 A1 * 10/2014 Swift A61B 1/32
 600/214
 2015/0238070 A1 * 8/2015 Lia A61B 1/0676
 600/223
 2016/0227994 A1 * 8/2016 Gotsch A61B 1/00082

FOREIGN PATENT DOCUMENTS

EM 000525191-0001 * 7/2006
 EM 002022020-0001 * 8/2014

OTHER PUBLICATIONS

Introducing the Orchid Open, announced Feb. 25, 2016 [online],
 [site visited Nov. 17, 2016]. Available from internet, URL: <<http://touchstonemedical.co.uk/introducing-orchid-open/>>.*
 Bridea Medical Twitter (@BrideaMedical), relevant posts for
 “Orchid Open” announced May 15, 2016, Feb. 25, 2016, Nov. 19,
 2015 [online], [site visited Nov. 17, 2016]. Available from internet,
 URL: <<https://twitter.com/brideamedical>>.*

* cited by examiner

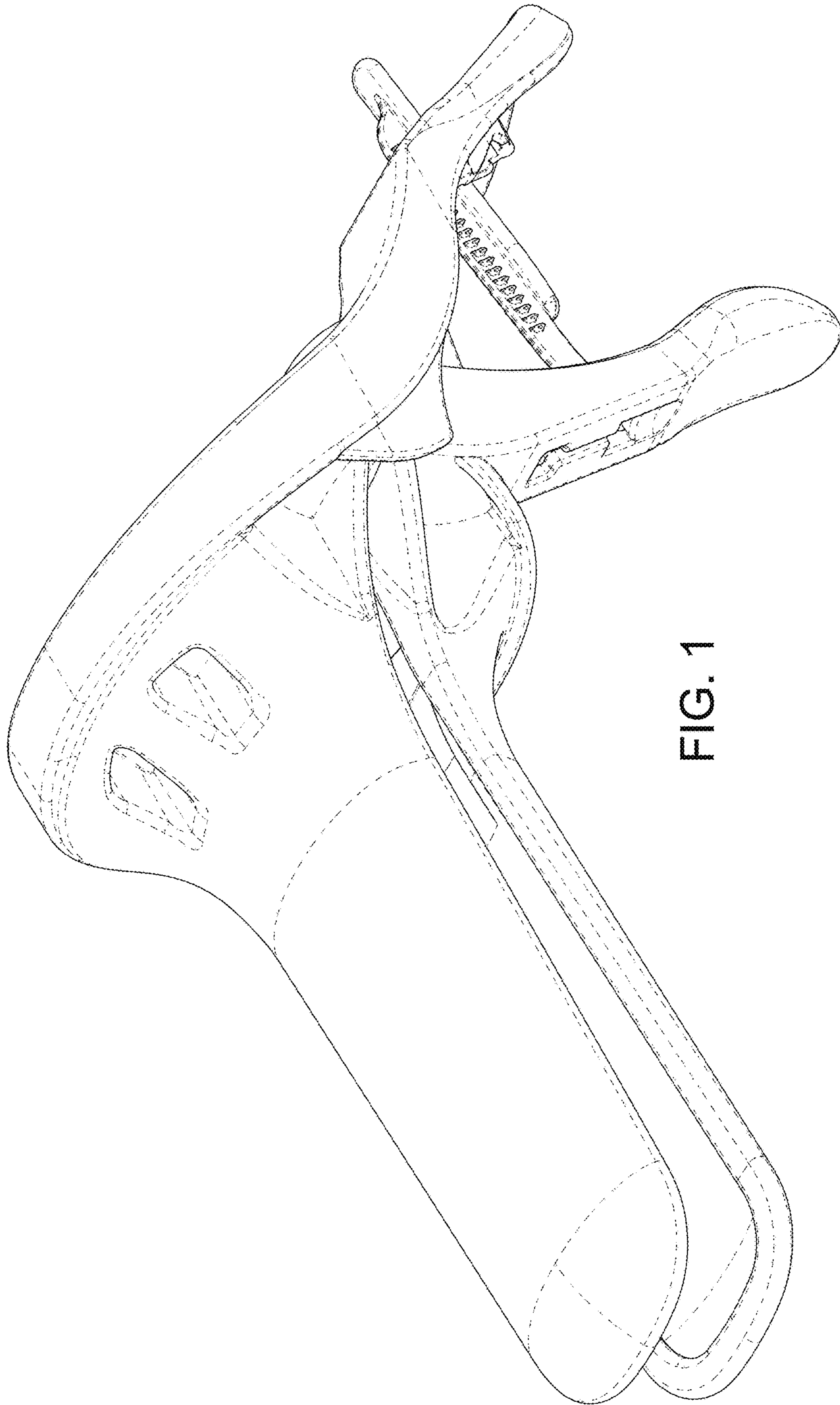

FIG. 1

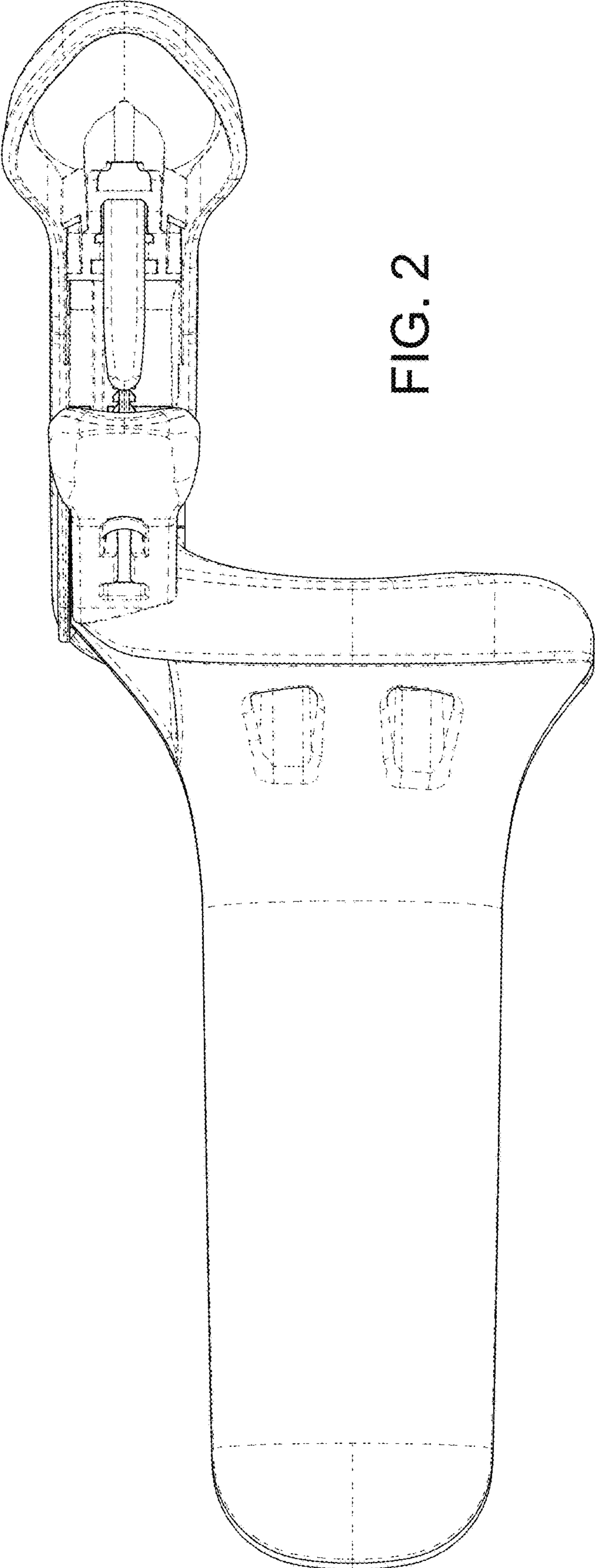

FIG. 2

FIG. 3

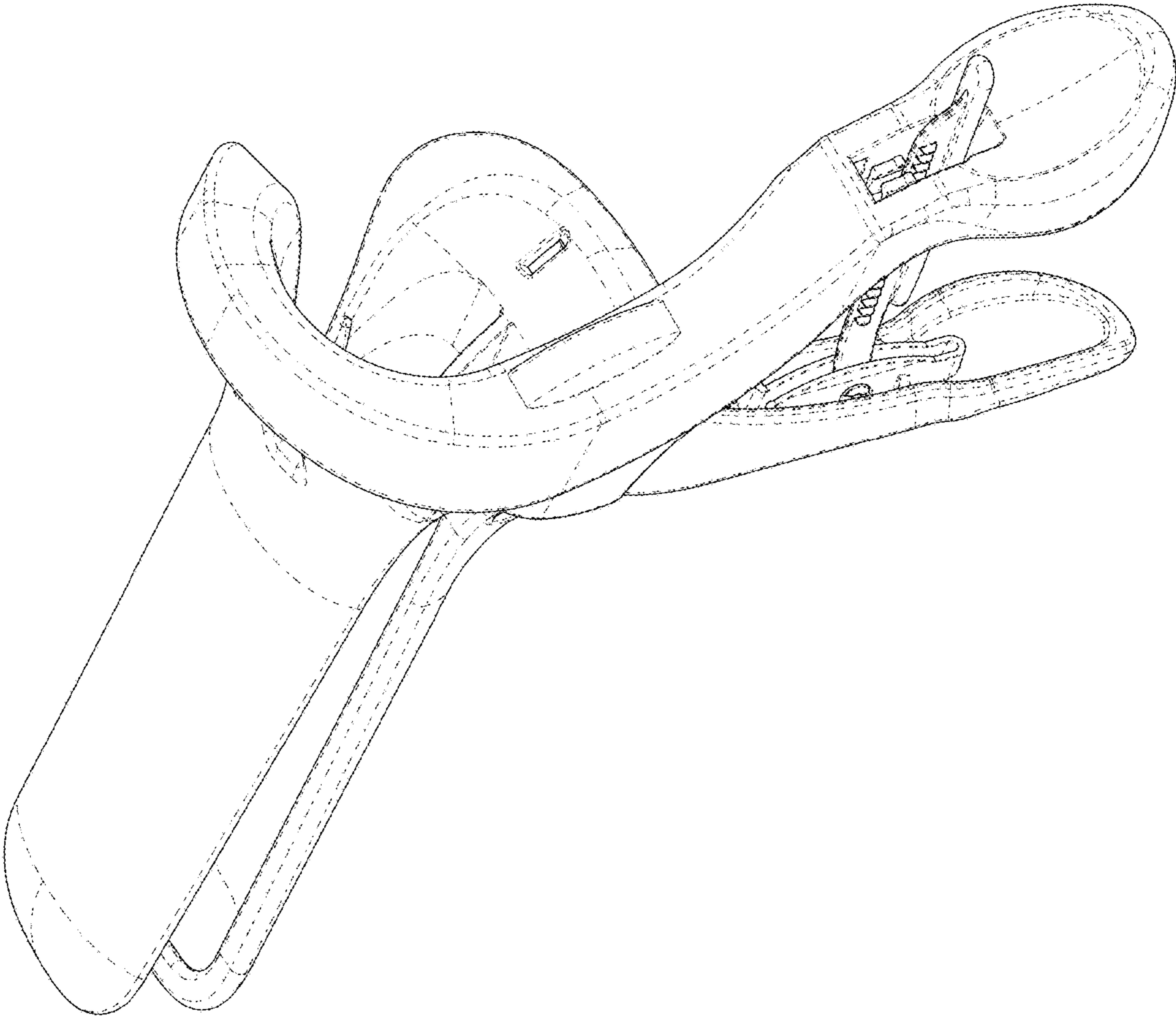

FIG. 4

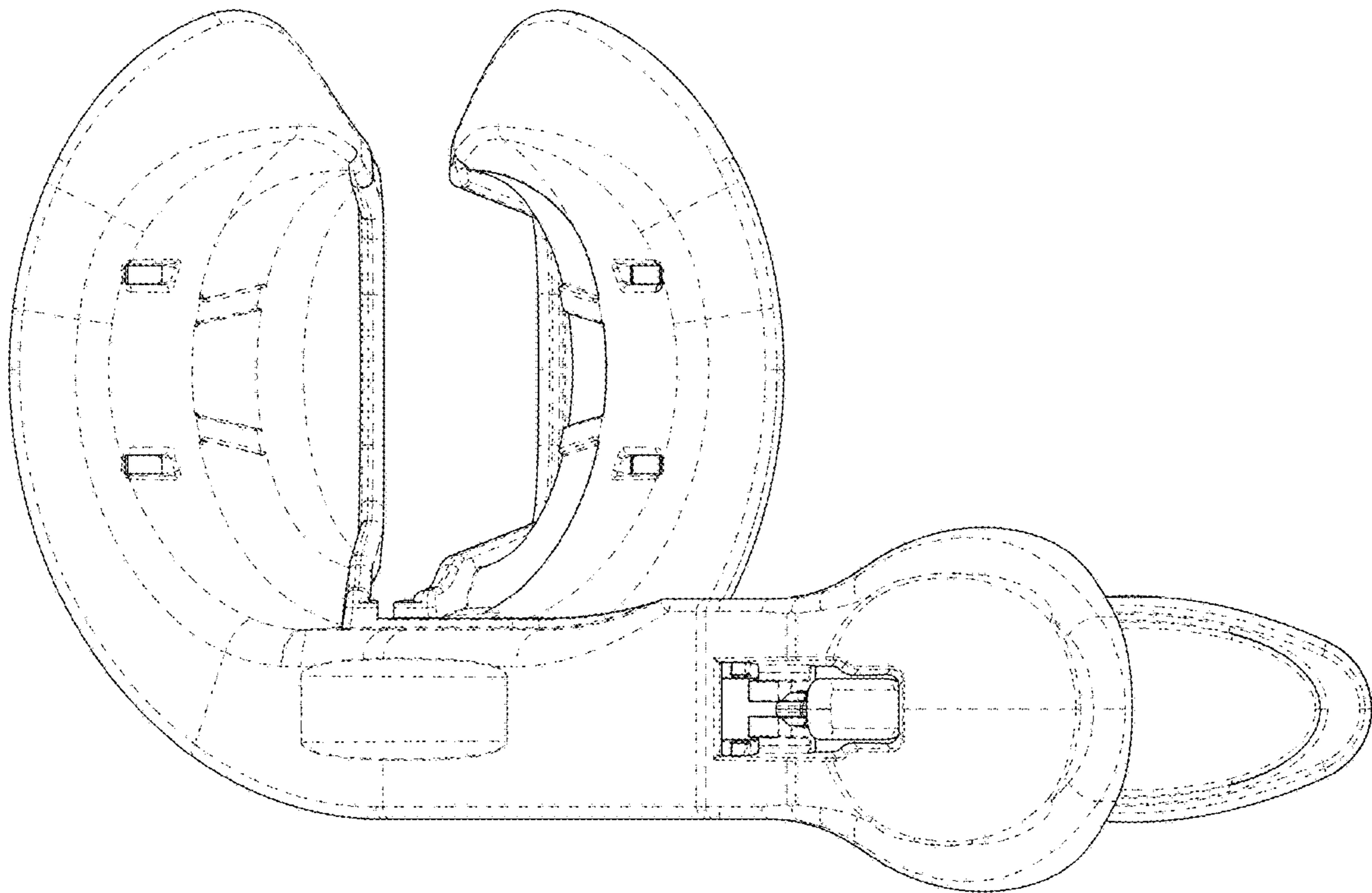
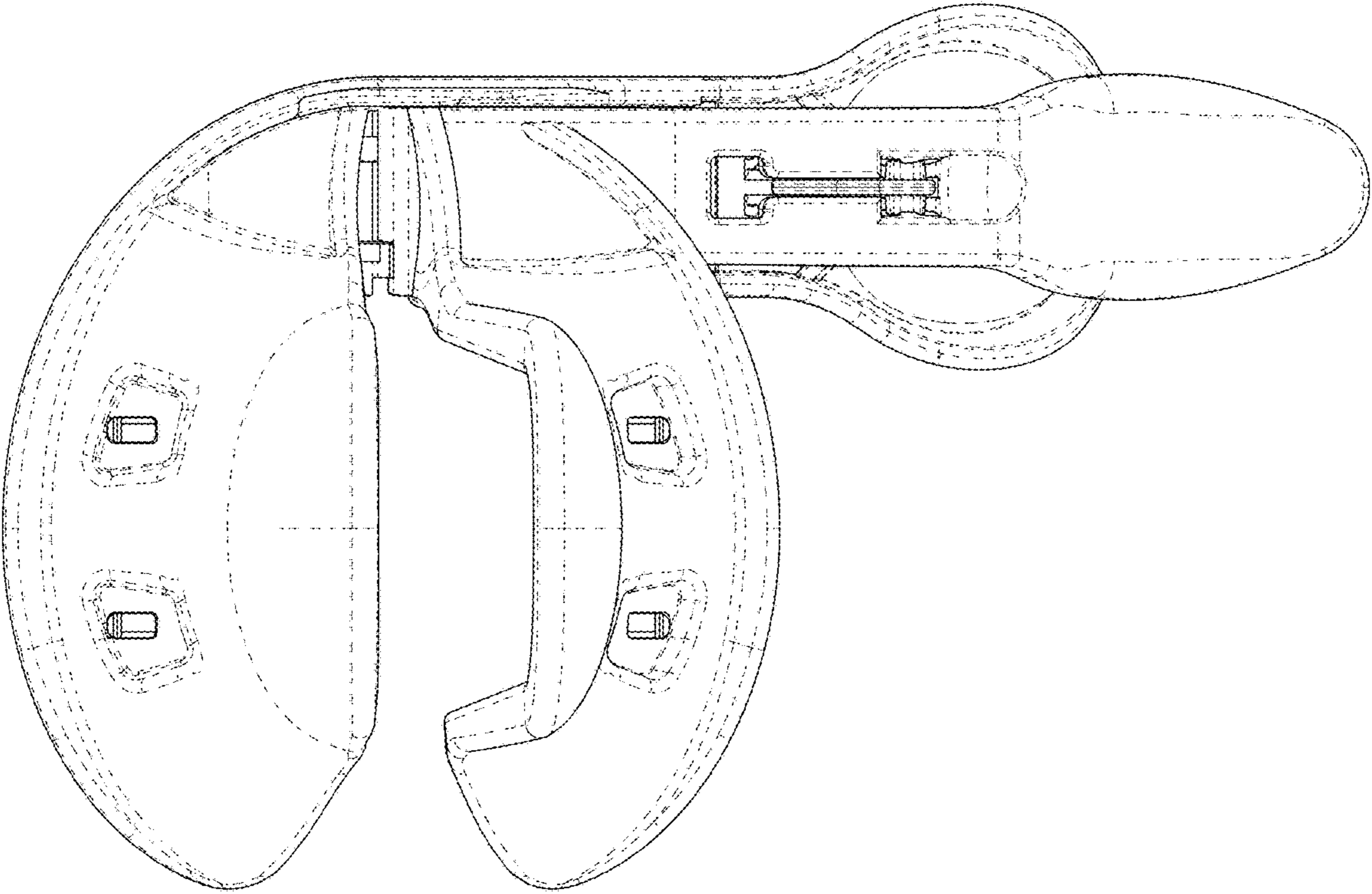

FIG. 5



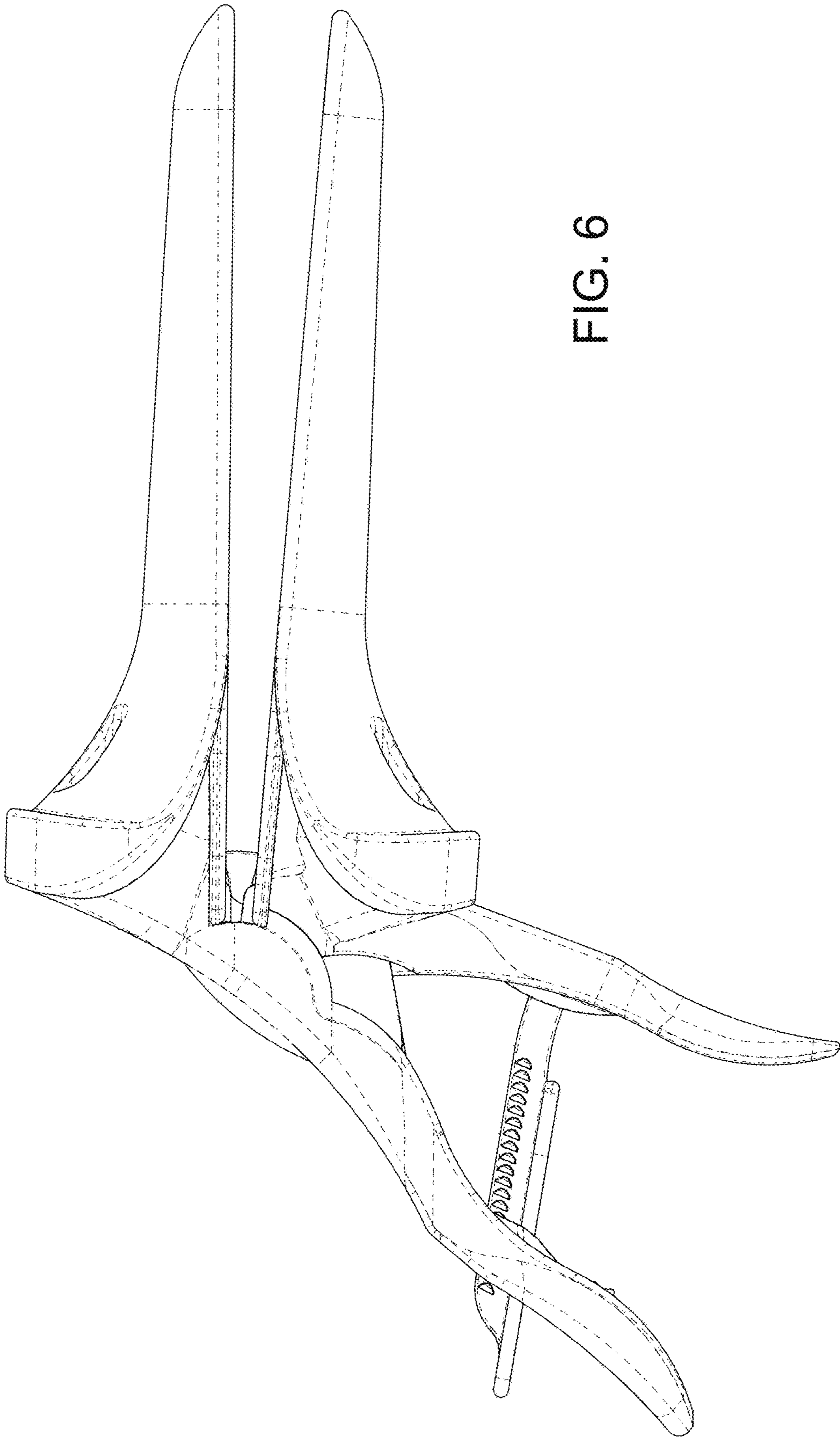

FIG. 6

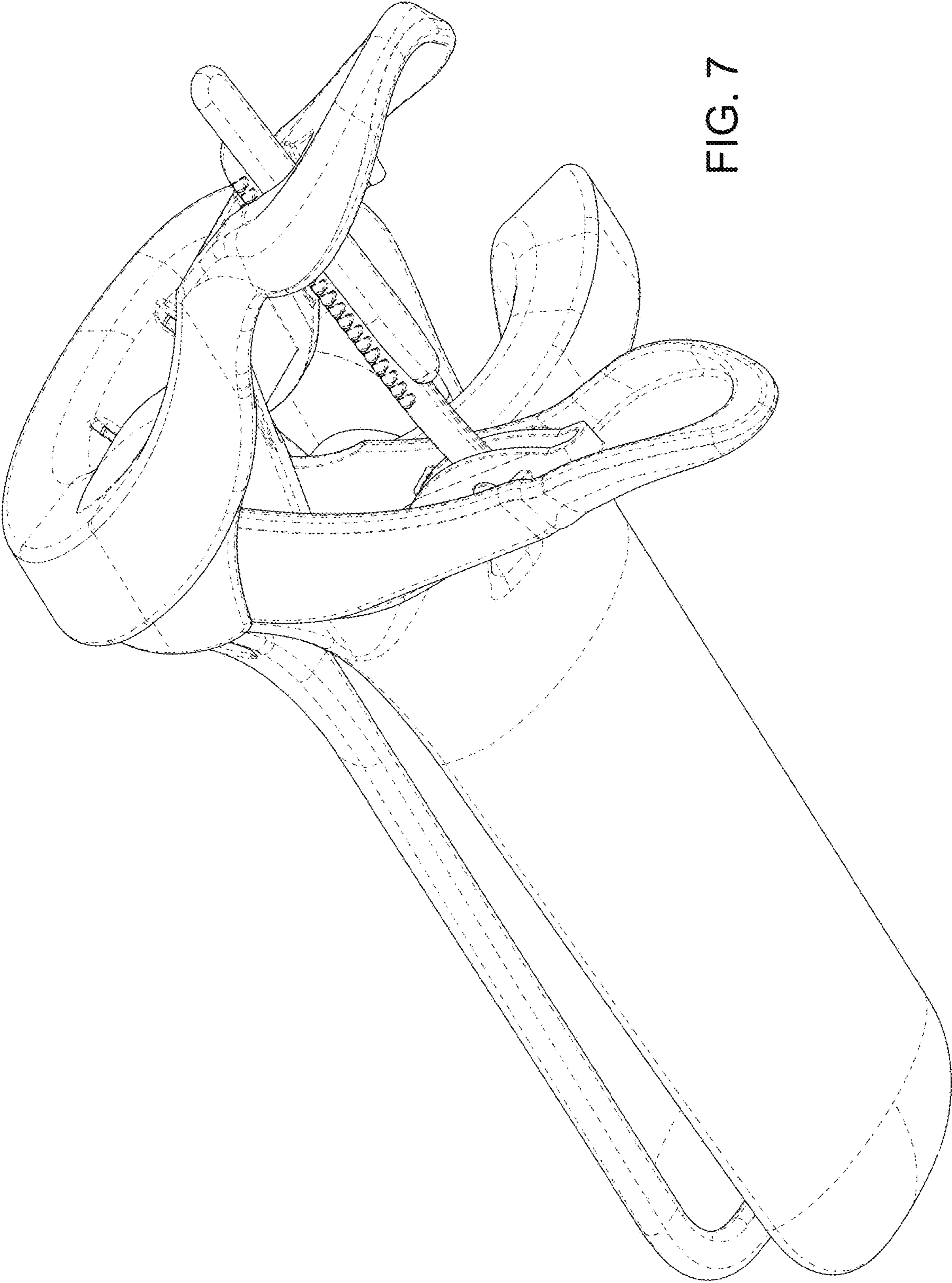

FIG. 7

FIG. 8

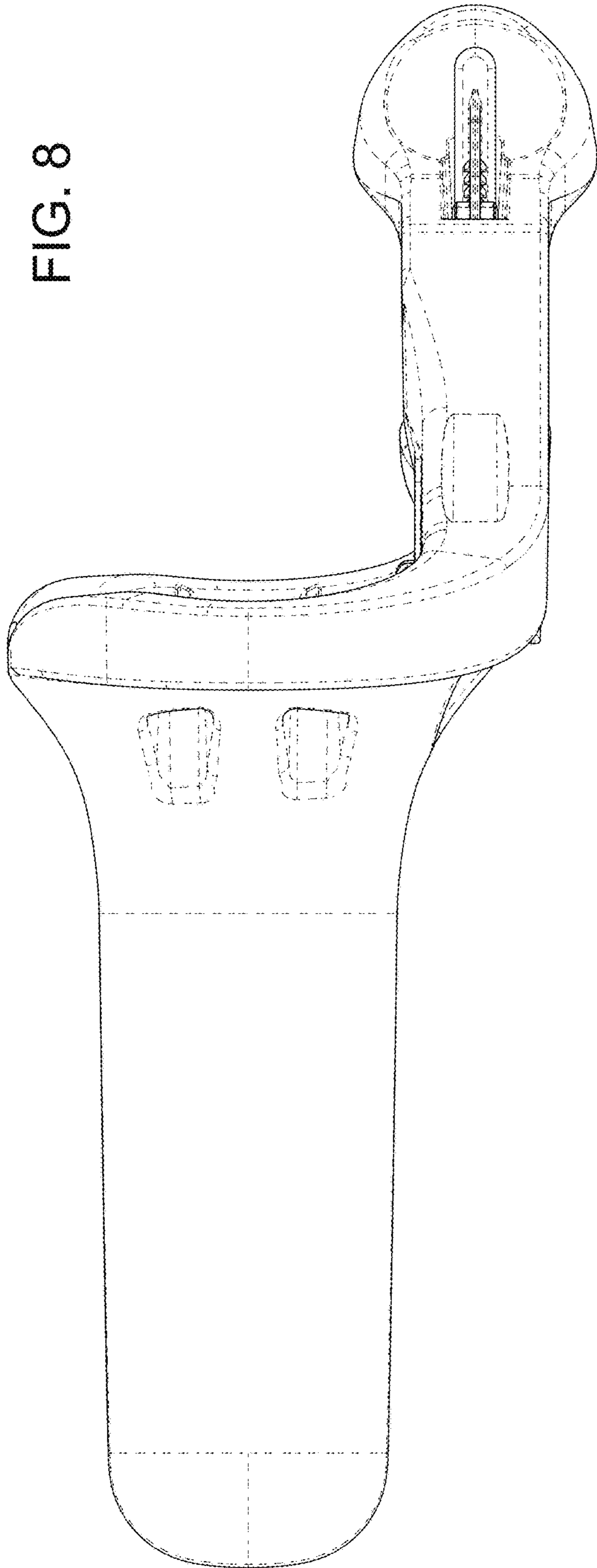

FIG. 9

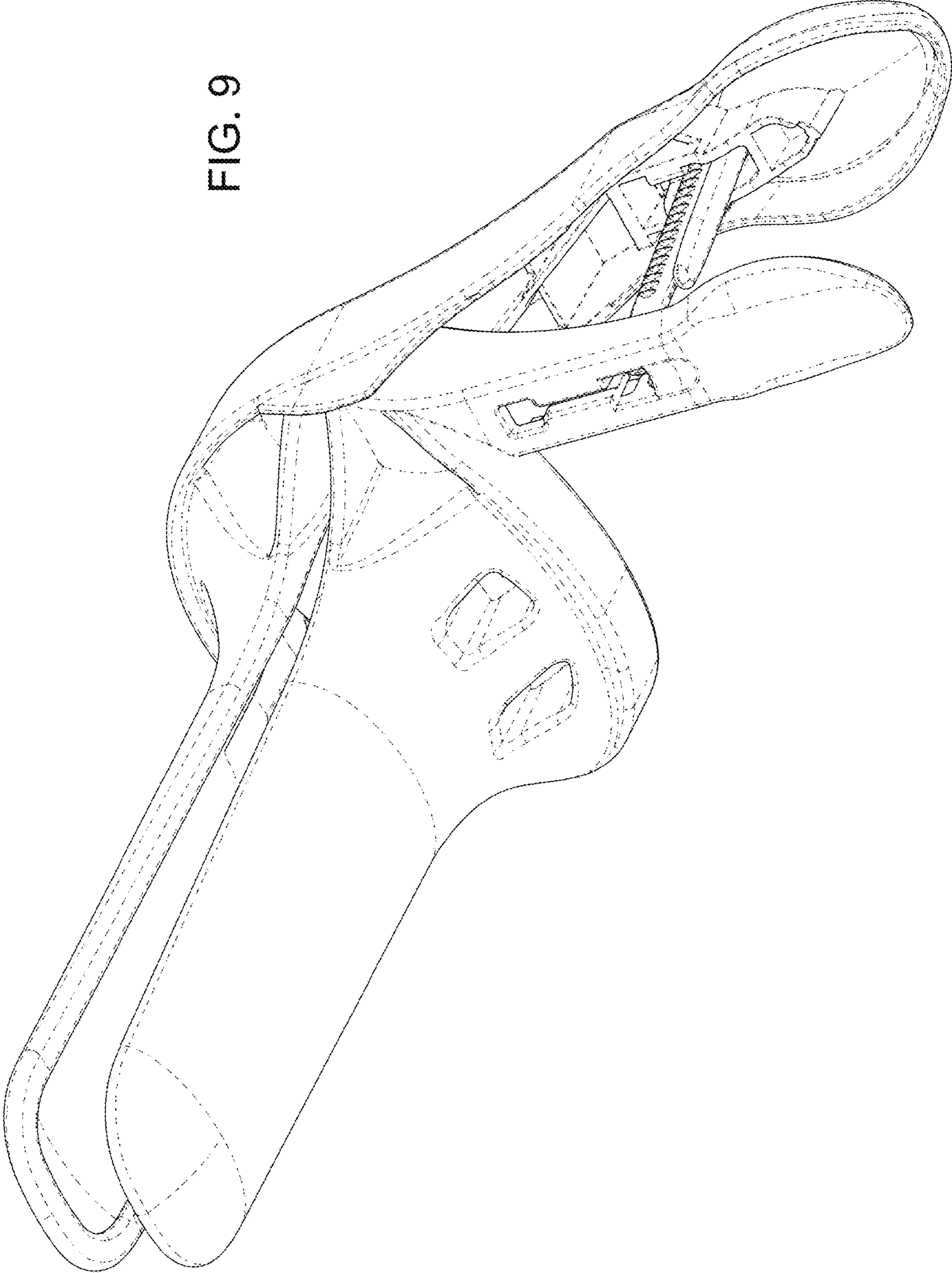
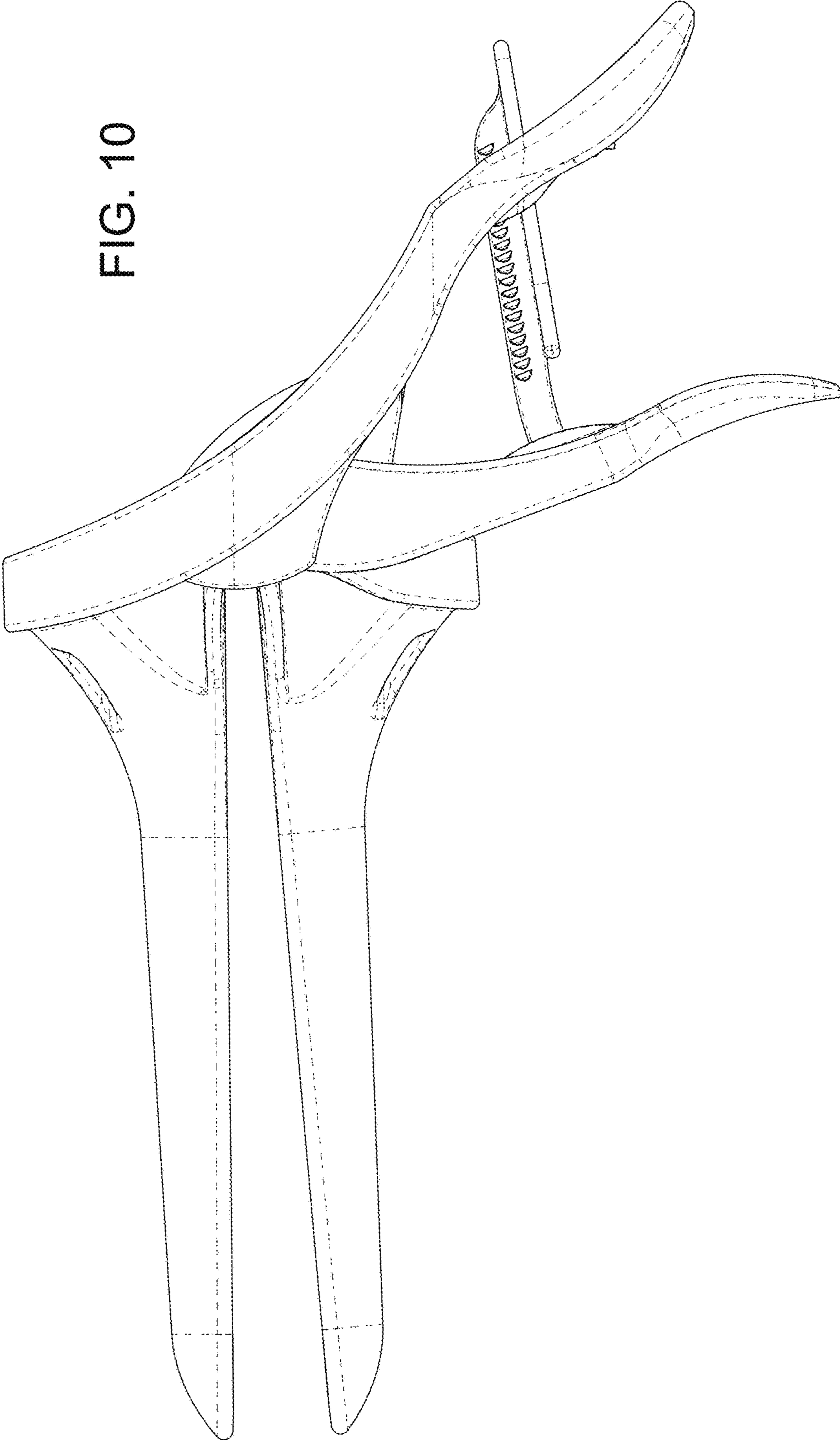

FIG. 10



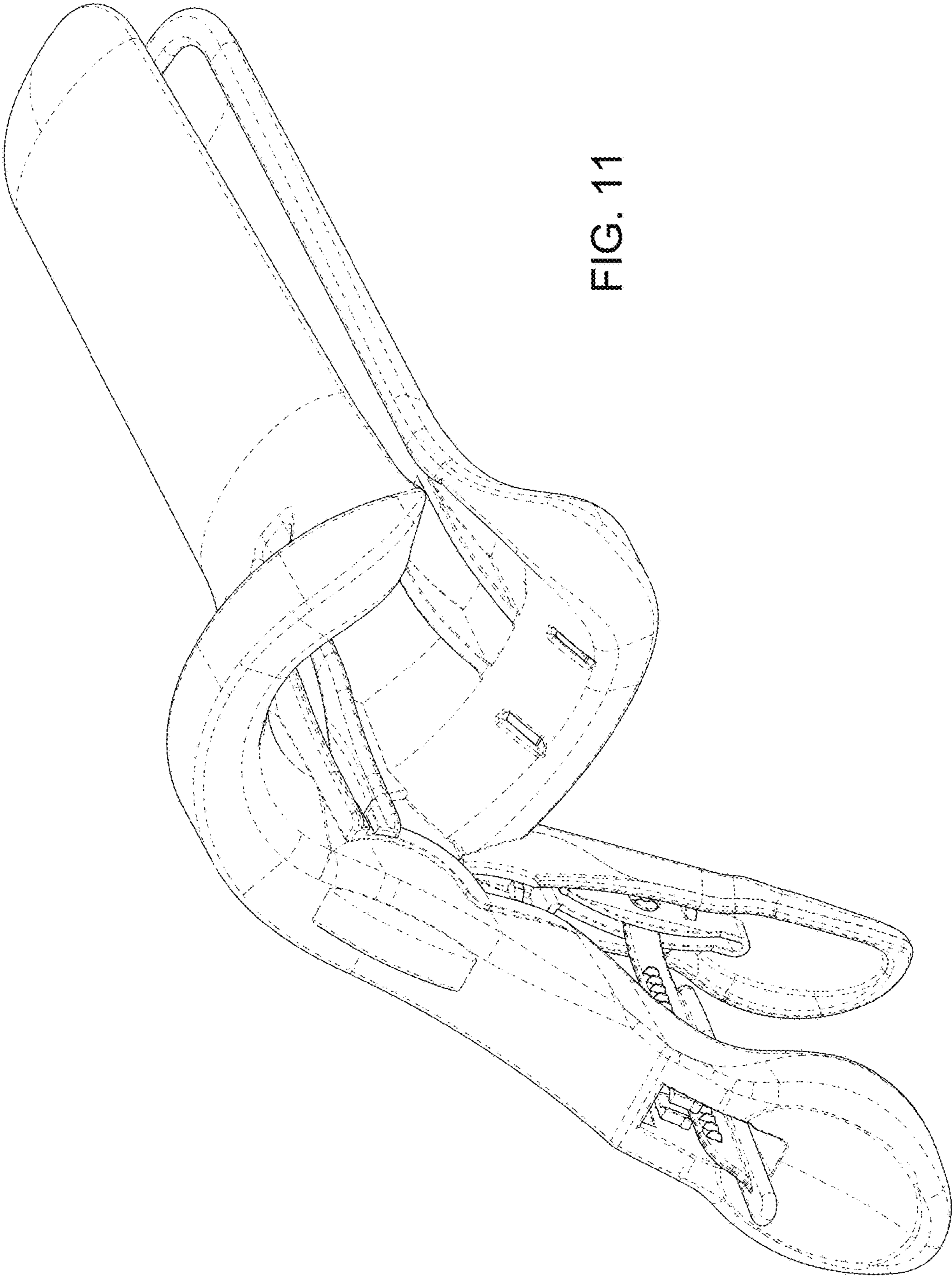

FIG. 11

FIG. 12

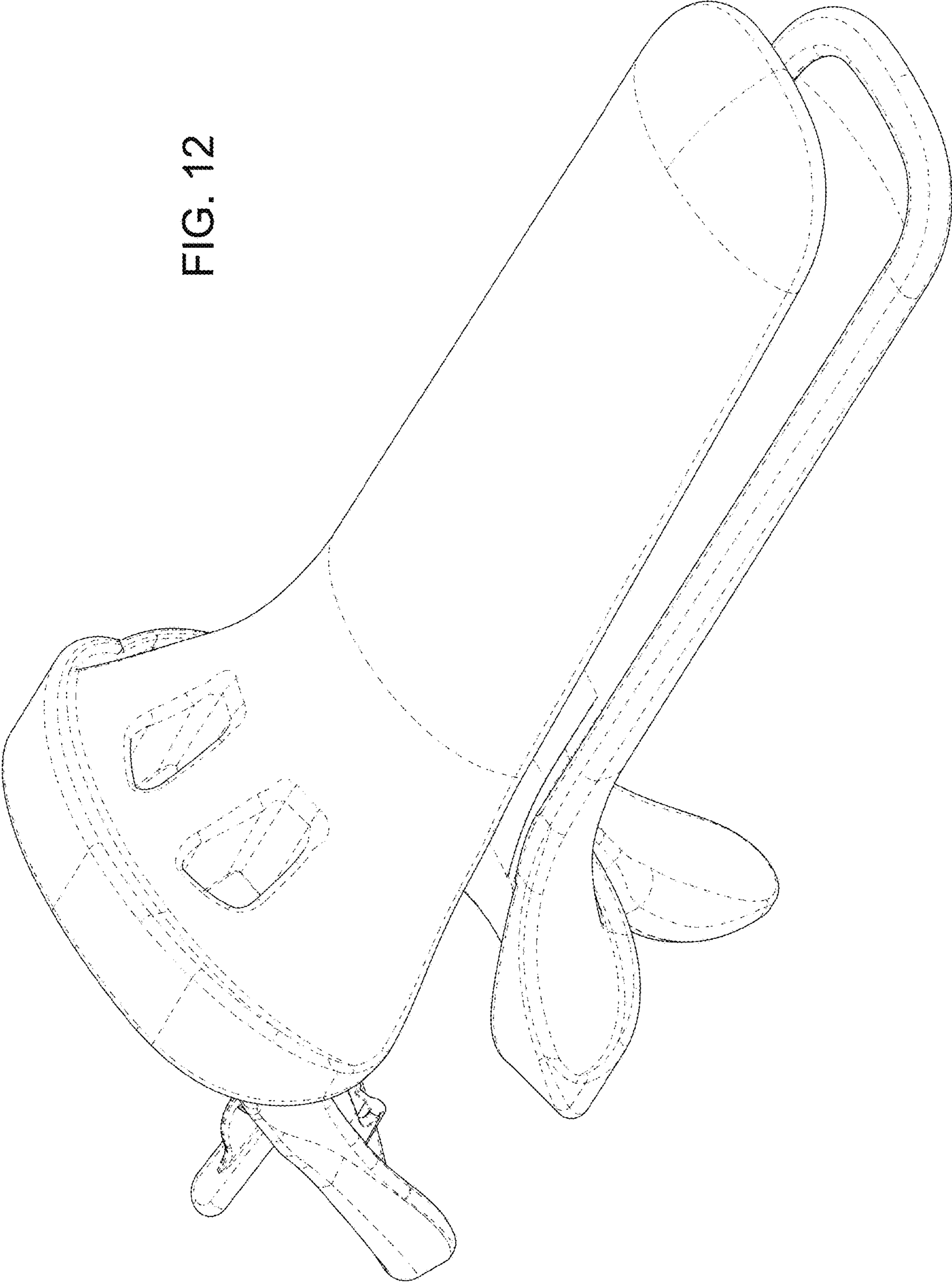
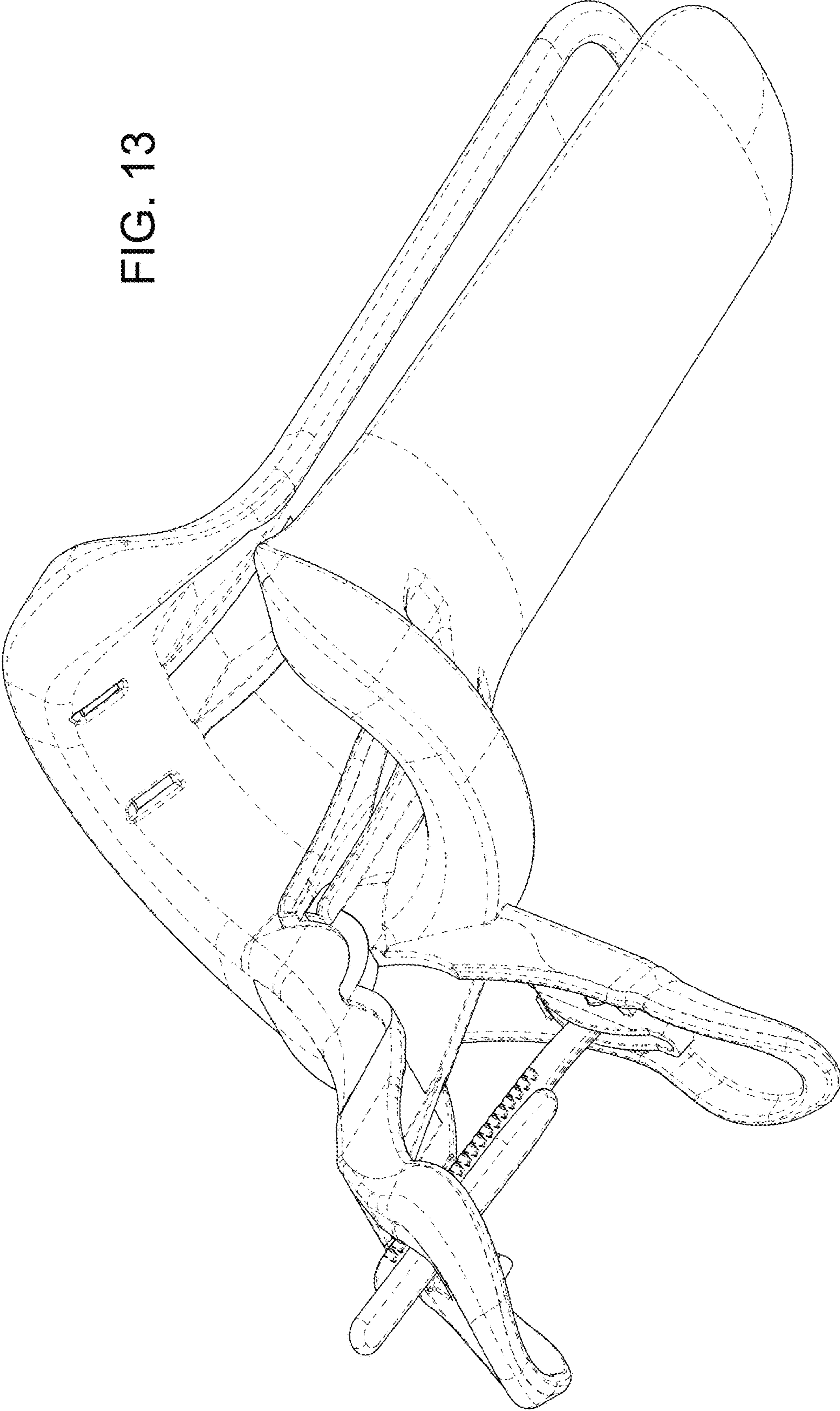

FIG. 13



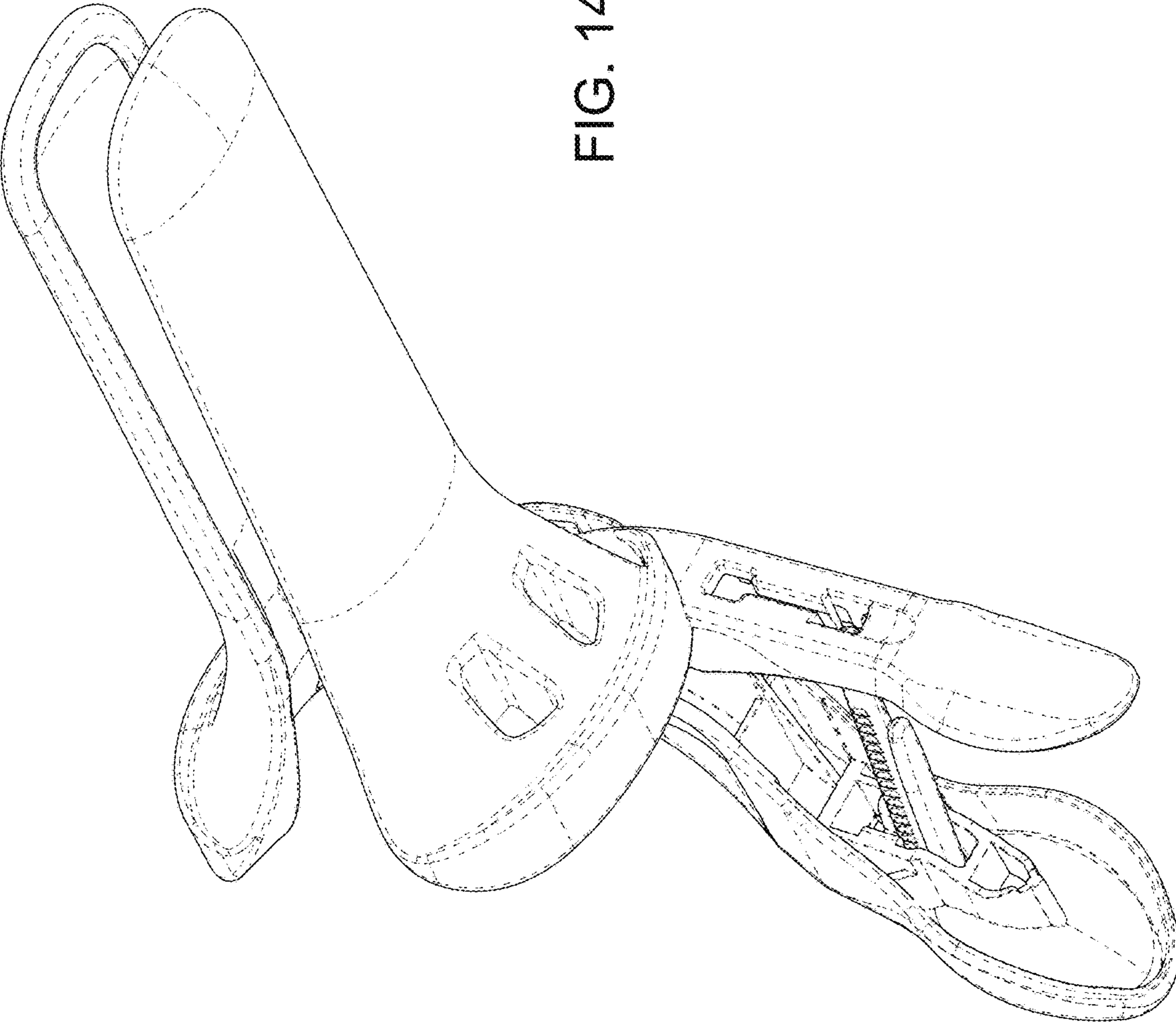

FIG. 14

UNITED STATES PATENT AND TRADEMARK OFFICE
CERTIFICATE OF CORRECTION

PATENT NO. : D785,171 S
APPLICATION NO. : 29/548949
DATED : April 25, 2017
INVENTOR(S) : Bob Roeloffs

Page 1 of 1

It is certified that error appears in the above-identified patent and that said Letters Patent is hereby corrected as shown below:

On the Title Page

Item (30) Foreign Application Priority Data is missing. Please insert:

--(30) Foreign Application Priority Data

November 16, 2015 (EM)002861567--

Signed and Sealed this
Seventeenth Day of September, 2019

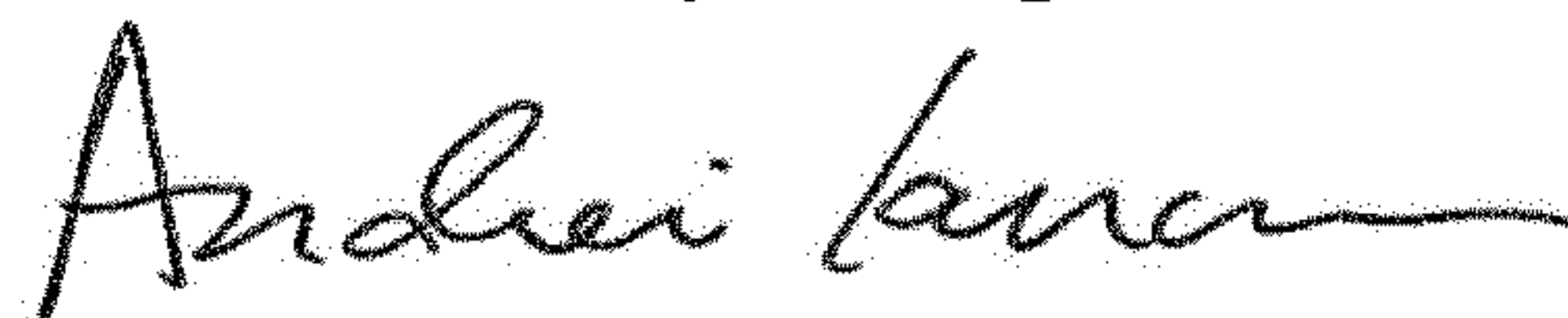

Andrei Iancu
Director of the United States Patent and Trademark Office