



US00D785090S

(12) **United States Design Patent** (10) **Patent No.:** **US D785,090 S**
Dlesk (45) **Date of Patent:** **** Apr. 25, 2017**

(54) **BI-FOLD LAMINATED GIFT CARD MAILER**

(56) **References Cited**

(71) Applicant: **Richard J Dlesk**, Wheeling, WV (US)

U.S. PATENT DOCUMENTS

(72) Inventor: **Richard J Dlesk**, Wheeling, WV (US)

D580,973	S	*	11/2008	Turner	D19/1
D591,341	S	*	4/2009	Fagan	D19/3
D621,872	S	*	8/2010	Jordan	D19/3
D629,459	S	*	12/2010	Clegg	D19/1
D638,469	S	*	5/2011	Bertinetti	D19/2
D643,060	S	*	8/2011	Clegg	D19/1
D706,867	S	*	6/2014	Jordan	D19/2

(73) Assignee: **CREATIVE COMMUNICATIONS LLC**, Wheeling, WV (US)

(**) Term: **15 Years**

* cited by examiner

(21) Appl. No.: **29/534,321**

Primary Examiner — Abraham Bahta

(22) Filed: **Jul. 28, 2015**

(57) **CLAIM**

(51) **LOC (10) Cl.** **19-01**

The ornamental design for a bi-fold laminated gift card mailer, as shown and described.

(52) **U.S. Cl.**

DESCRIPTION

USPC **D19/2**

(58) **Field of Classification Search**

USPC D19/1-12, 20-34; 40/124.01-124.15, 40/661, 672, 726, 776; 283/72, 74-75, 283/103, 105-107, 82, 70, 94; D21/385; D20/10-11, 22, 27, 40, 42; D14/435-437; 360/2; 235/380, 382; 340/572.8, 691.6, 572.7, 572.1, 815.4; 343/878, 866, 700 MS, 871, 881

CPC .. B42D 15/022; B42D 15/042; B42D 15/045; B42D 15/027; B42D 25/00; B42D 25/20; B42D 25/30; B42D 2033/00; B42D 2033/02; B42D 2033/04; B42D 2033/08; B42D 2033/10; B42D 2033/16; B42D 2033/20; B42D 2033/22; B42D 2033/28; B42D 2033/30

FIG. 1 is a perspective view of gift card mailer showing my new design;
 FIG. 2 is a front elevational view thereof;
 FIG. 3 is a rear elevational view thereof;
 FIG. 4 is a left side elevational view thereof;
 FIG. 5 is a right side elevational view thereof;
 FIG. 6 is a top plan view thereof;
 FIG. 7 is a bottom plan view thereof;
 FIG. 8 is a perspective view thereof slightly exposing the interior of the gift card mailer;
 FIG. 9 is a perspective view thereof completely exposing the interior of the gift card mailer; and,
 FIG. 10 is an exploded view thereof.

The broken line showing of perforations is included for the purpose of illustrating environmental structure and forms no part of the claimed design.

See application file for complete search history.

1 Claim, 10 Drawing Sheets

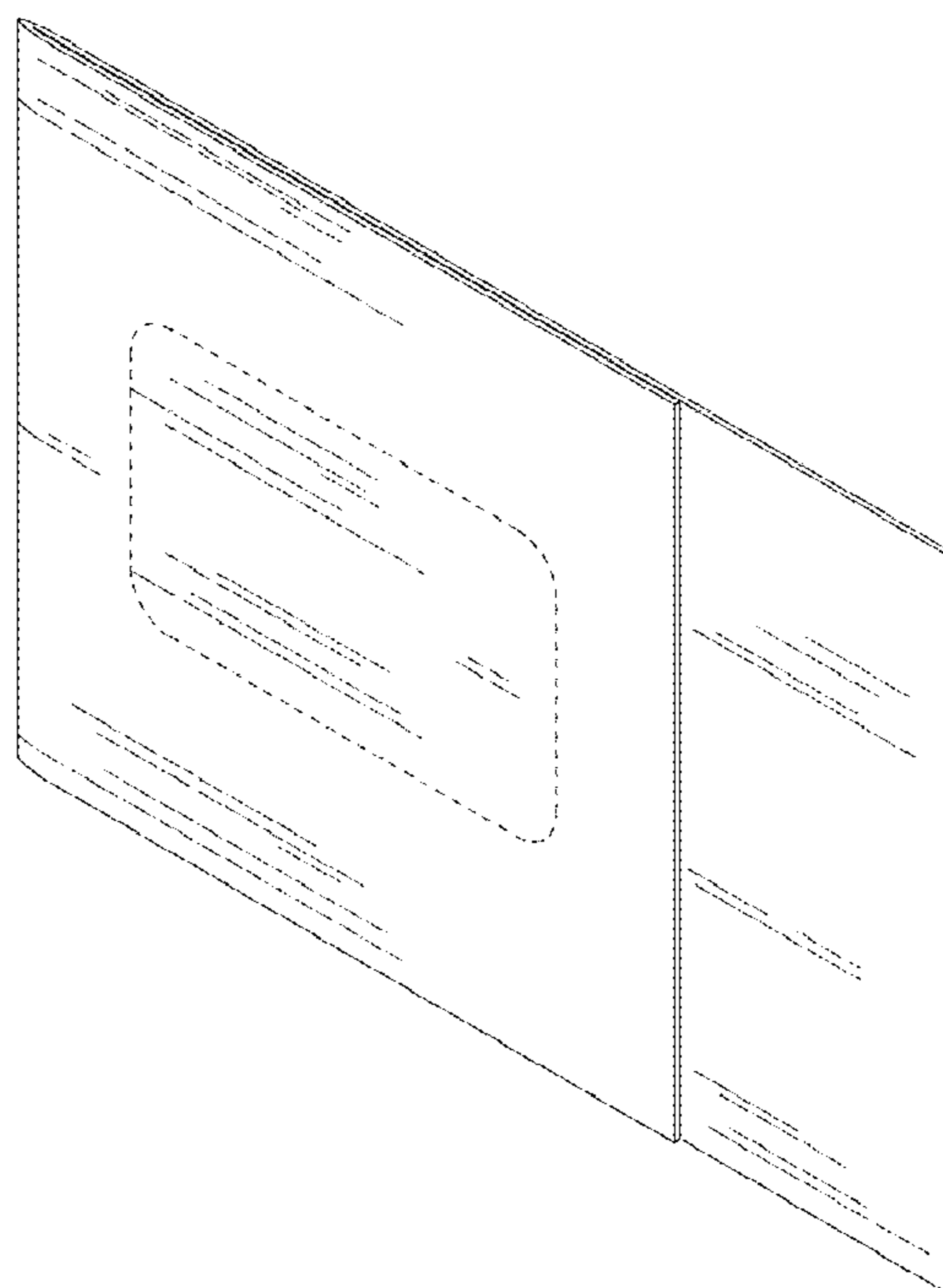

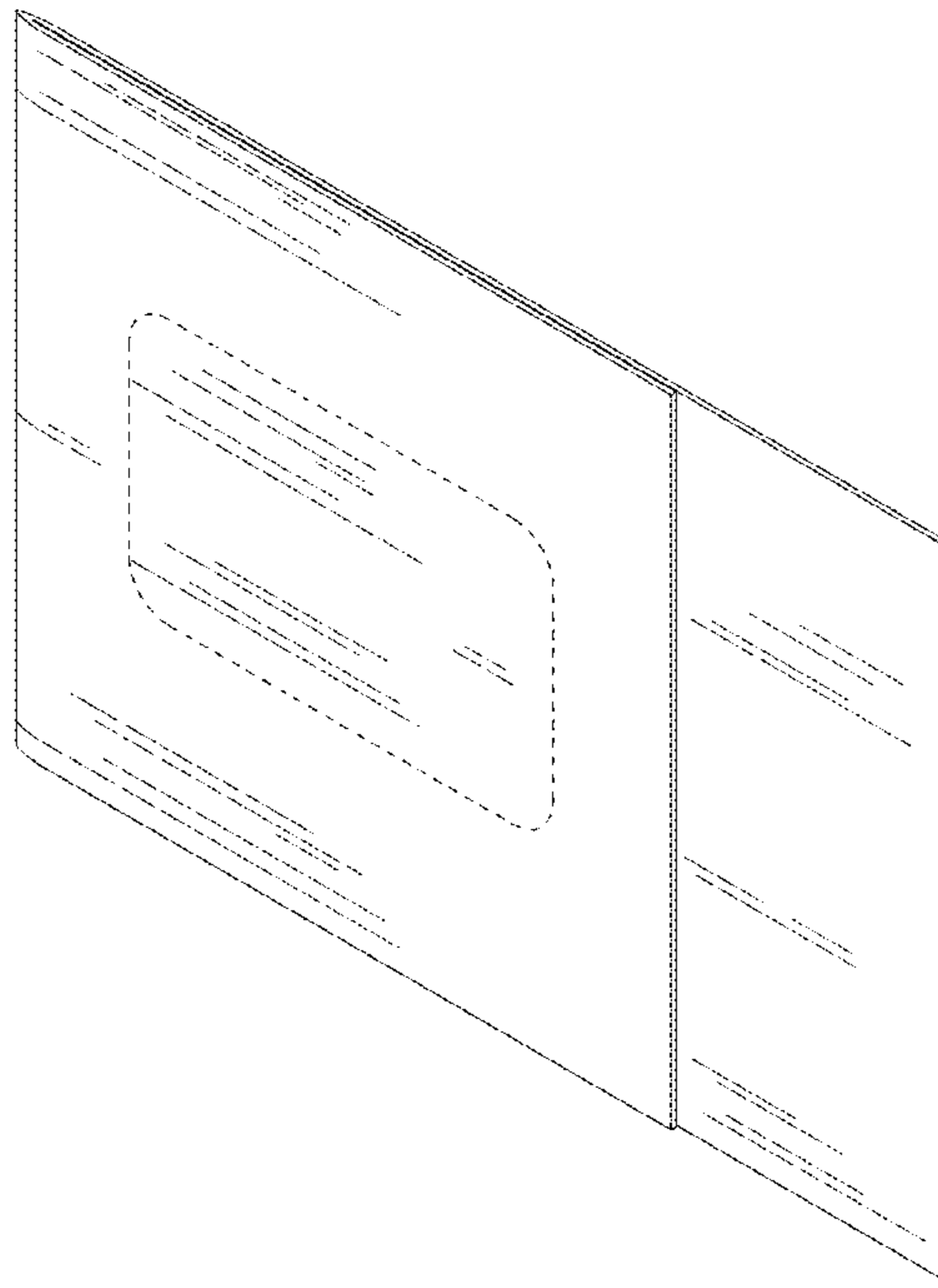

FIG. 1

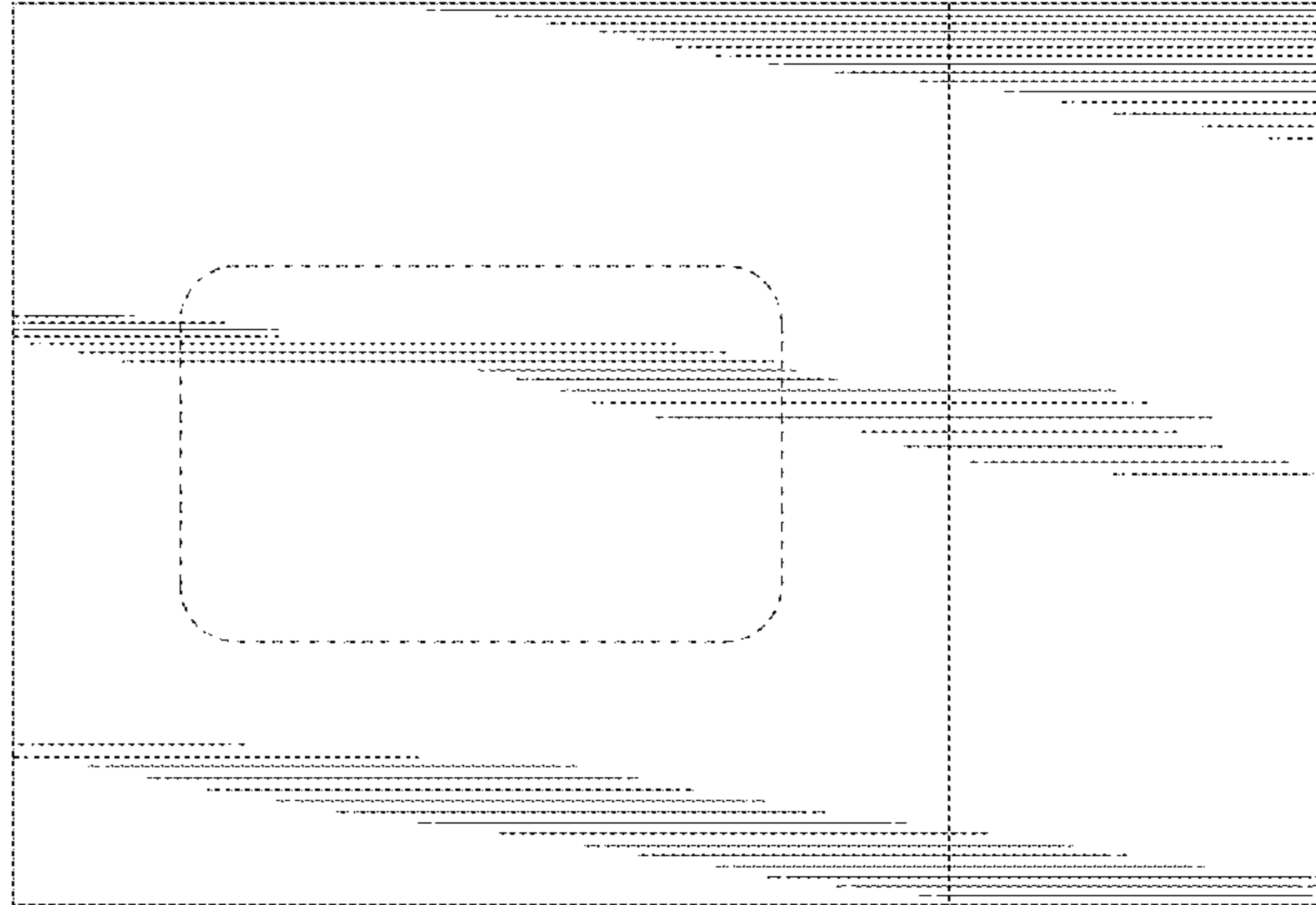

FIG. 2

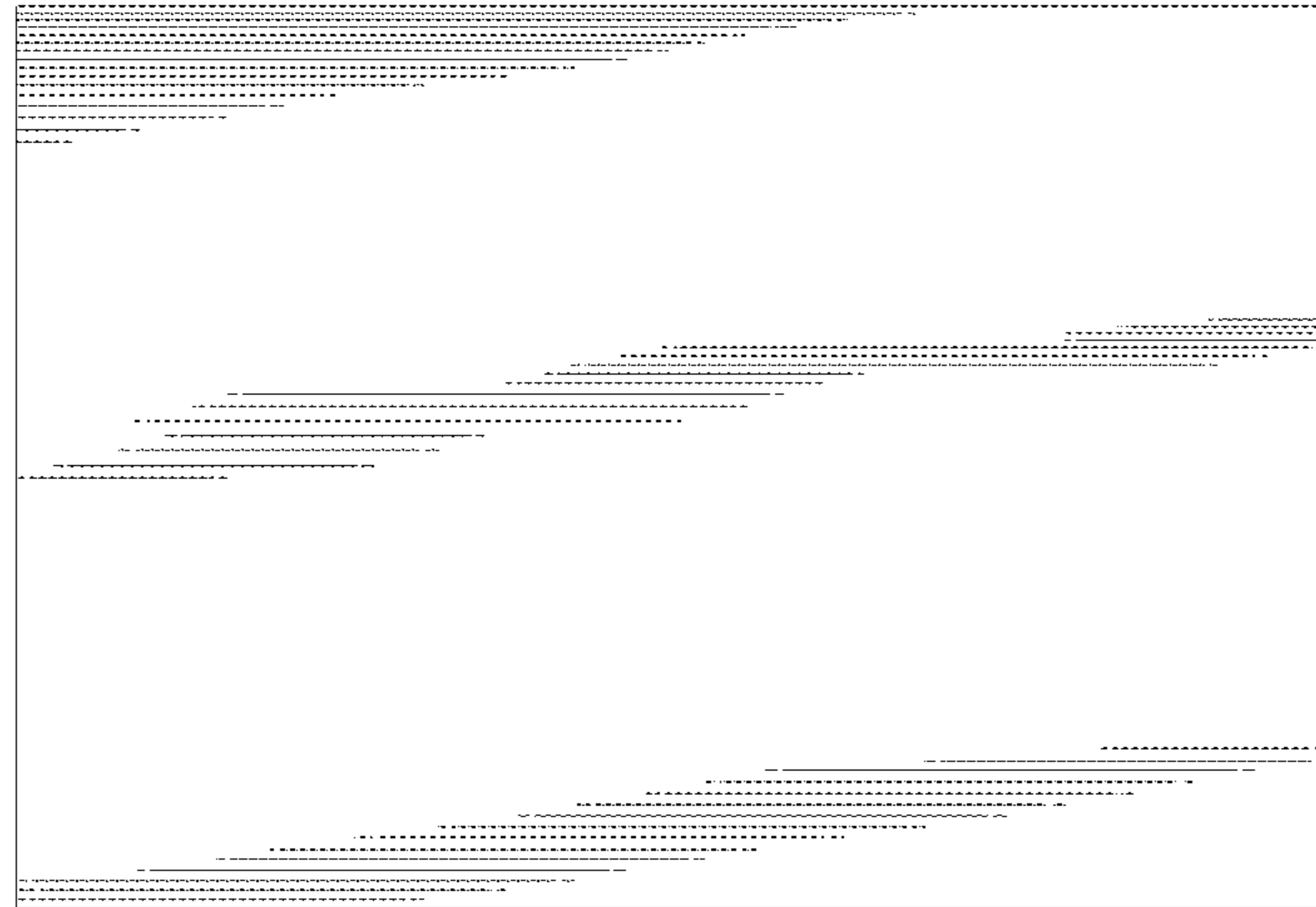

FIG. 3

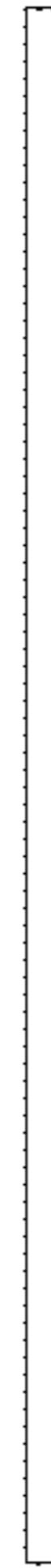

FIG. 4



FIG. 5

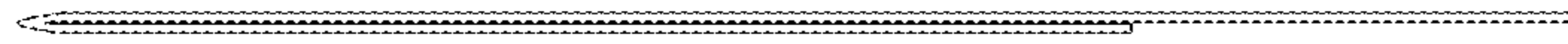

FIG. 6

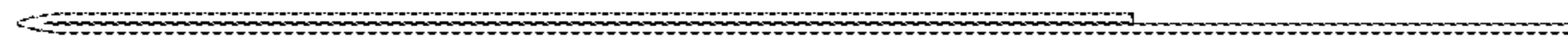

FIG. 7

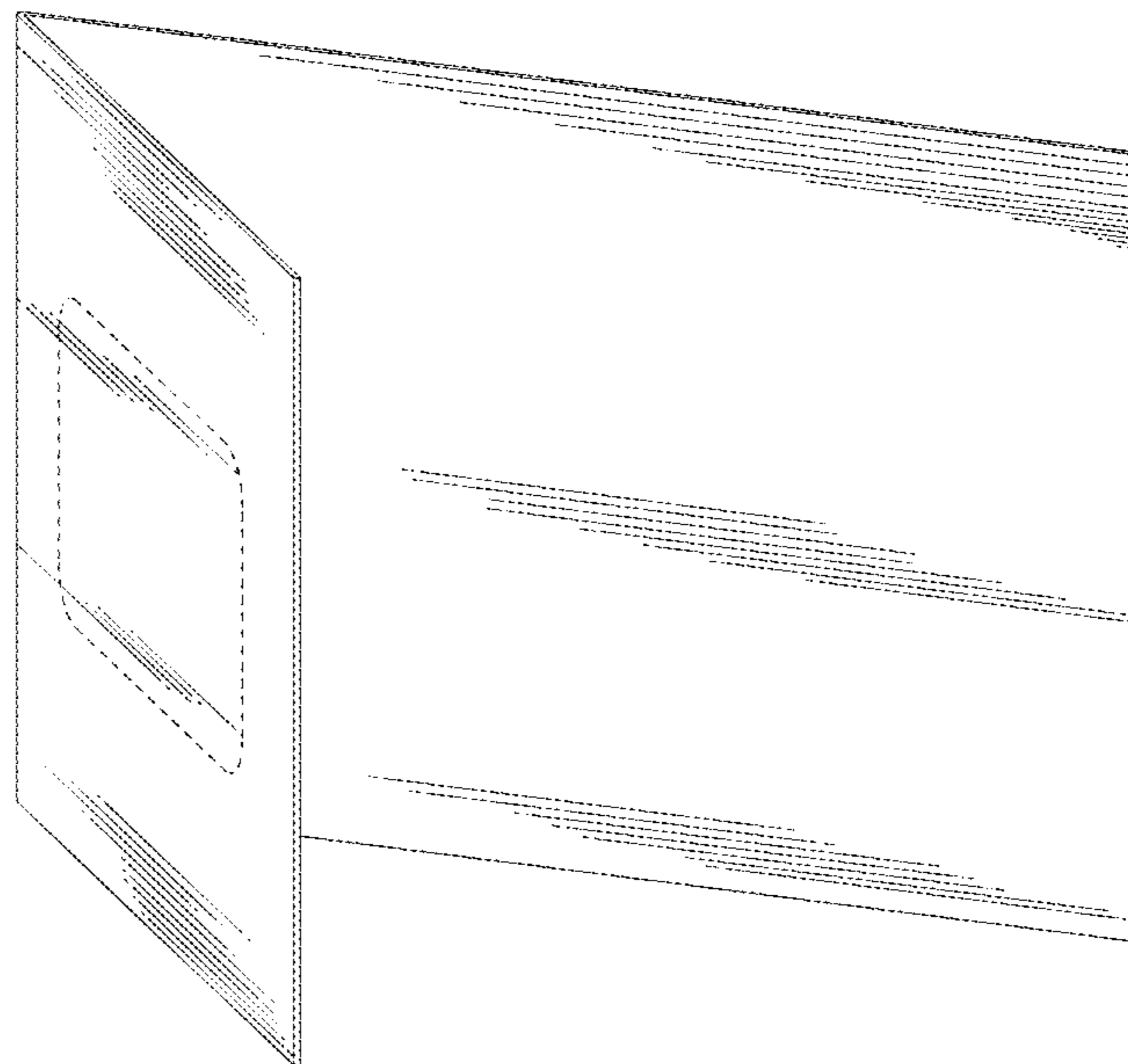

FIG. 8

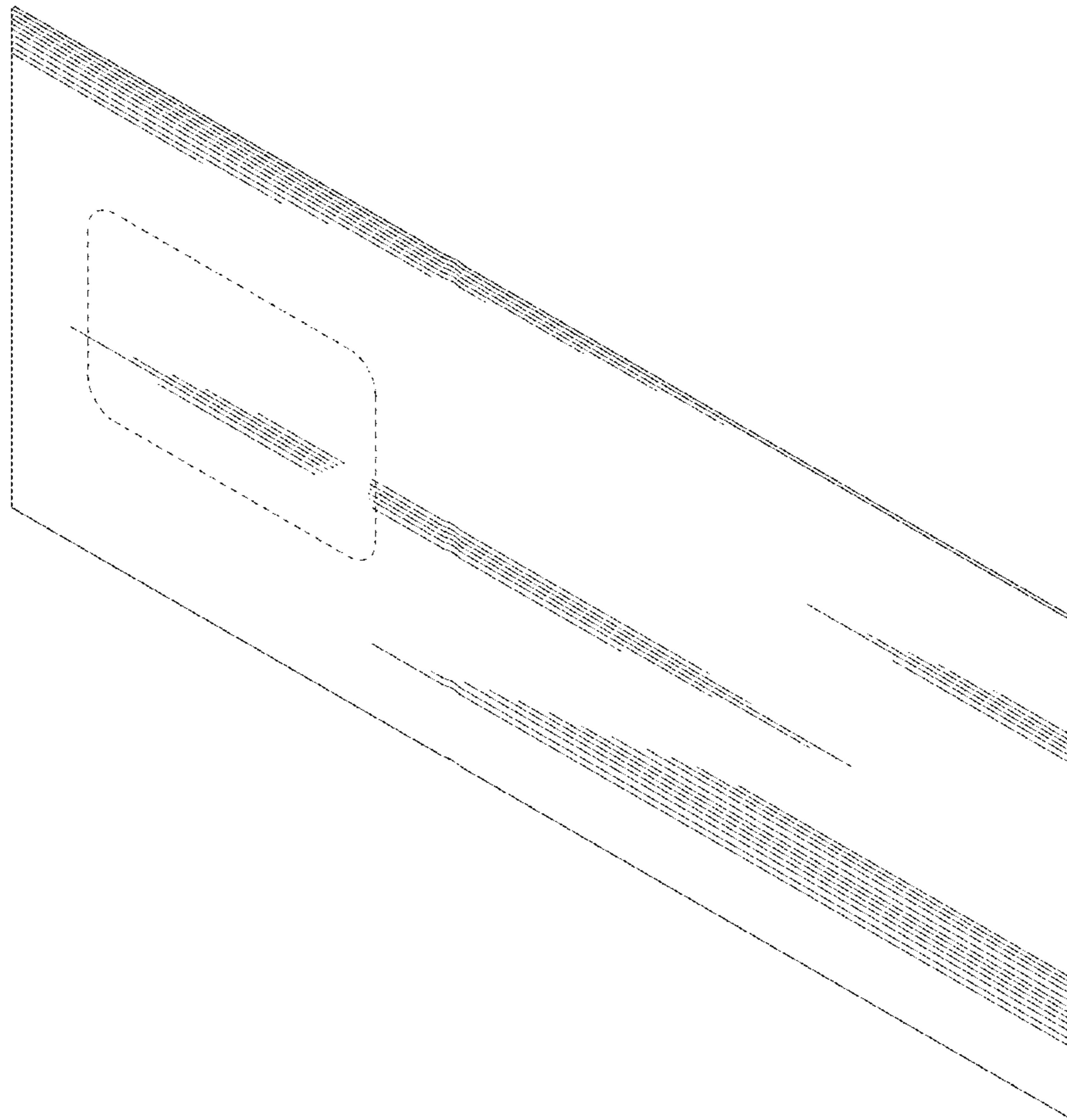

FIG. 9

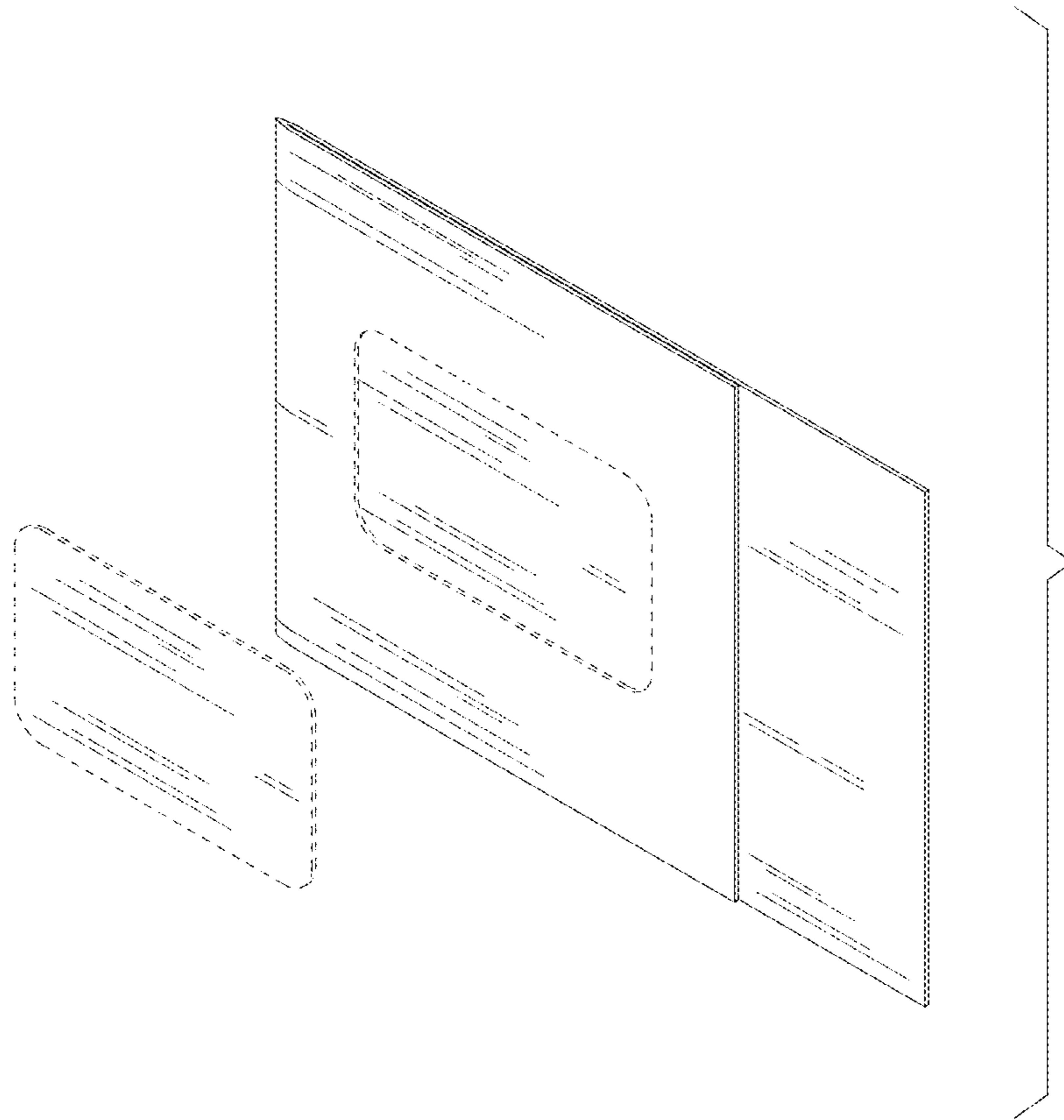

FIG. 10