



US00D785013S

(12) **United States Design Patent** (10) **Patent No.:** **US D785,013 S**
Kuhn et al. (45) **Date of Patent:** **** Apr. 25, 2017**

(54) **DISPLAY SCREEN OR PORTION THEREOF WITH AN ANIMATED GRAPHICAL USER INTERFACE**

Primary Examiner — Mary Ann Calabrese
Assistant Examiner — Jennifer L Rempfer
(74) *Attorney, Agent, or Firm* — Johnson, Marcou & Isaacs, LLC

(71) Applicant: **GOOGLE INC.**, Mountain View, CA (US)

(72) Inventors: **Stephen Kuhn**, Tarrytown, NY (US);
Angelie Zaslavsky, Weehawken, NJ (US)

(57) **CLAIM**

The ornamental design for a display screen or portion thereof with an animated graphical user interface, as shown and described.

(73) Assignee: **GOOGLE INC.**, Mountain View, CA (US)

(**) Term: **15 Years**

DESCRIPTION

(21) Appl. No.: **29/578,194**

(22) Filed: **Sep. 19, 2016**

Related U.S. Application Data

(62) Division of application No. 29/481,320, filed on Feb. 4, 2014, now Pat. No. Des. 769,889.

(51) **LOC (10) Cl.** **14-04**

(52) **U.S. Cl.**
USPC **D14/485**

(58) **Field of Classification Search**
USPC D14/485-495; D20/10, 11, 17, 22, 27;
D12/192

(Continued)

(56) **References Cited**

U.S. PATENT DOCUMENTS

D599,812 S 9/2009 Hirsch
D609,717 S 2/2010 Yokouchi et al.

(Continued)

OTHER PUBLICATIONS

Altamirano, "Mexican Office Action issued in Mexican Application No. MX/f/2014/001512", mailed on Aug. 19, 2015, 3 pages of English Translation and 3 pages of Mexican Office Action.

(Continued)

FIG. 1 is a front view of a first image in a sequence for a first embodiment of a display screen or portion thereof with an animated graphical user interface;

FIG. 2 is a front view of a second image thereof;

FIG. 3 is a front view of a third image thereof;

FIG. 4 is a front view of a fourth image thereof;

FIG. 5 is a front view of a fifth image thereof;

FIG. 6 is a front view of a sixth image thereof;

FIG. 7 is a front view of a seventh image thereof;

FIG. 8 is a front view of a first image in a sequence for a second embodiment of a display screen or portion thereof with an animated graphical user interface.

FIG. 9 is a front view of a second image thereof;

FIG. 10 is a front view of a third image thereof;

FIG. 11 is a front view of a fourth image thereof;

FIG. 12 is a front view of a fifth image thereof;

FIG. 13 is a front view of a sixth image thereof; and,

FIG. 14 is a front view of a seventh image thereof.

The appearance of the animated user interface sequentially transitions between the images shown in FIGS. 1-7 and in FIGS. 8-14. The process or period in which an image transitions into another image forms no part of the claimed design. The broken line showing of the display screen or portion thereof and graphical elements within the display screen illustrates unclaimed environment and forms no part of the claimed design.

1 Claim, 14 Drawing Sheets

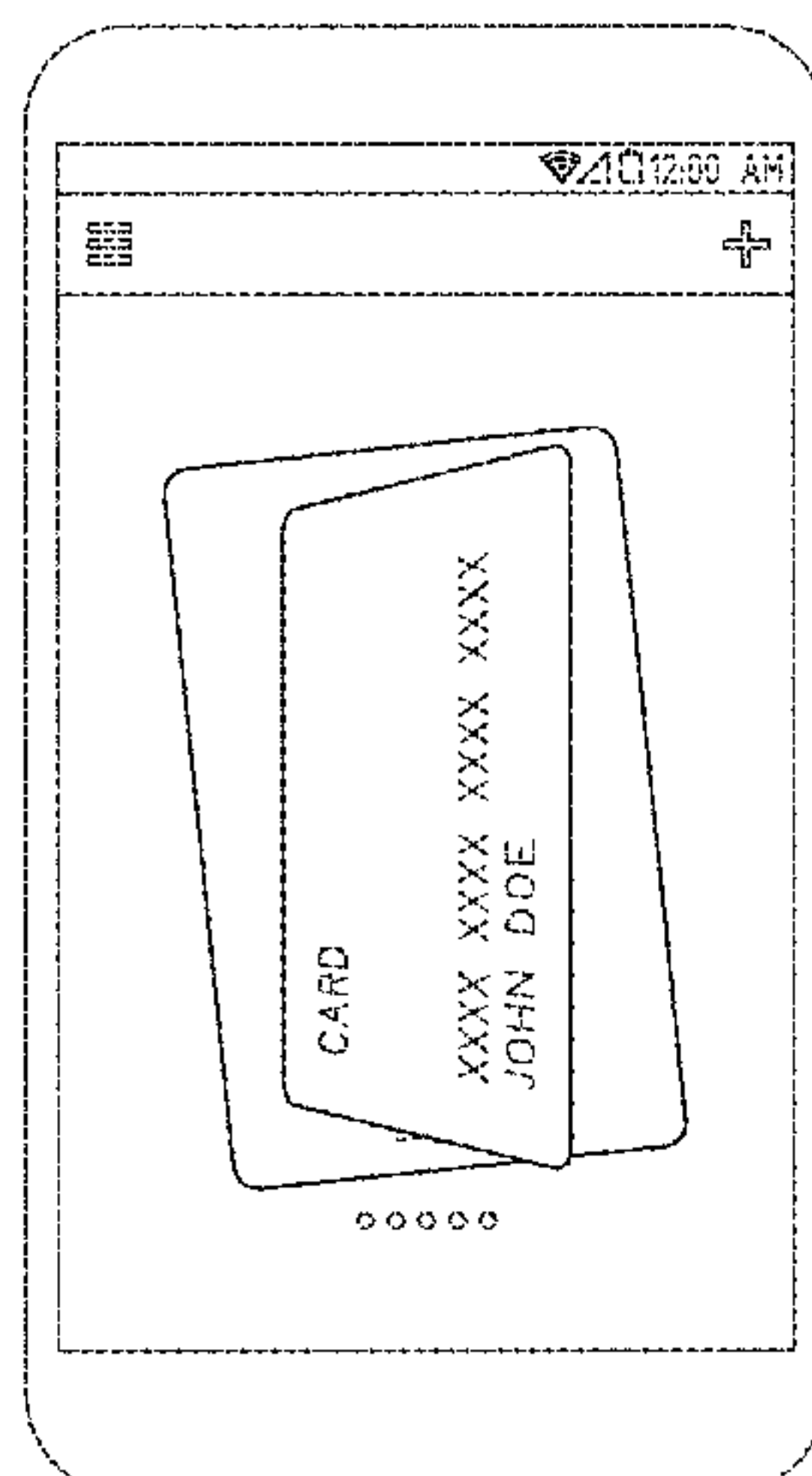

(58) **Field of Classification Search**

CPC G06F 3/048; G06F 3/0481; G06F 3/04812;
 G06F 3/04817; G06F 3/0482; G06F
 3/0483; G06F 3/0484; G06F 3/04842;
 G06F 3/0485; G06F 3/04855; G06F
 3/04886; G06F 15/0225; H04N 21/00;
 H04N 5/4403; G06Q 30/00

See application file for complete search history.

D730,383 S	5/2015	Brinda et al.	
D737,848 S	9/2015	Brinda et al.	
D738,906 S	9/2015	Frijlink et al.	
D753,702 S *	4/2016	Zhou	D14/488
D755,832 S *	5/2016	Liu	D14/488
D761,802 S *	7/2016	Moon	D14/485
D763,905 S *	8/2016	Patel	D14/488
D766,927 S *	9/2016	Li	D14/485
D769,889 S *	10/2016	Kuhn	D14/485
D773,481 S *	12/2016	Everette	D14/485

(56)

References Cited

U.S. PATENT DOCUMENTS

D628,582 S	12/2010	Kurozumi et al.
D640,284 S	6/2011	Woo et al.
D651,608 S	1/2012	Allen et al.
D651,609 S	1/2012	Pearson et al.
D681,044 S	4/2013	Sakata
D689,510 S	9/2013	Rodrigues et al.
D701,528 S	3/2014	Brinda et al.
D721,721 S	1/2015	Seung-Hyuck

OTHER PUBLICATIONS

Dumont, "Canada Office Action received for Canada Patent Application No. 156817", mailed on Dec. 23, 2014, 2 pages.

Dumont, "Canada Office Action received for Canada Patent Application No. 156817", mailed on Jul. 7, 2015, 3 pages.

Seontae, "Korean Office Action issued in Korean Application No. 30-2014-0024070", mailed on Jul. 7, 2014, 2 pages of Korean Office Action only.

* cited by examiner

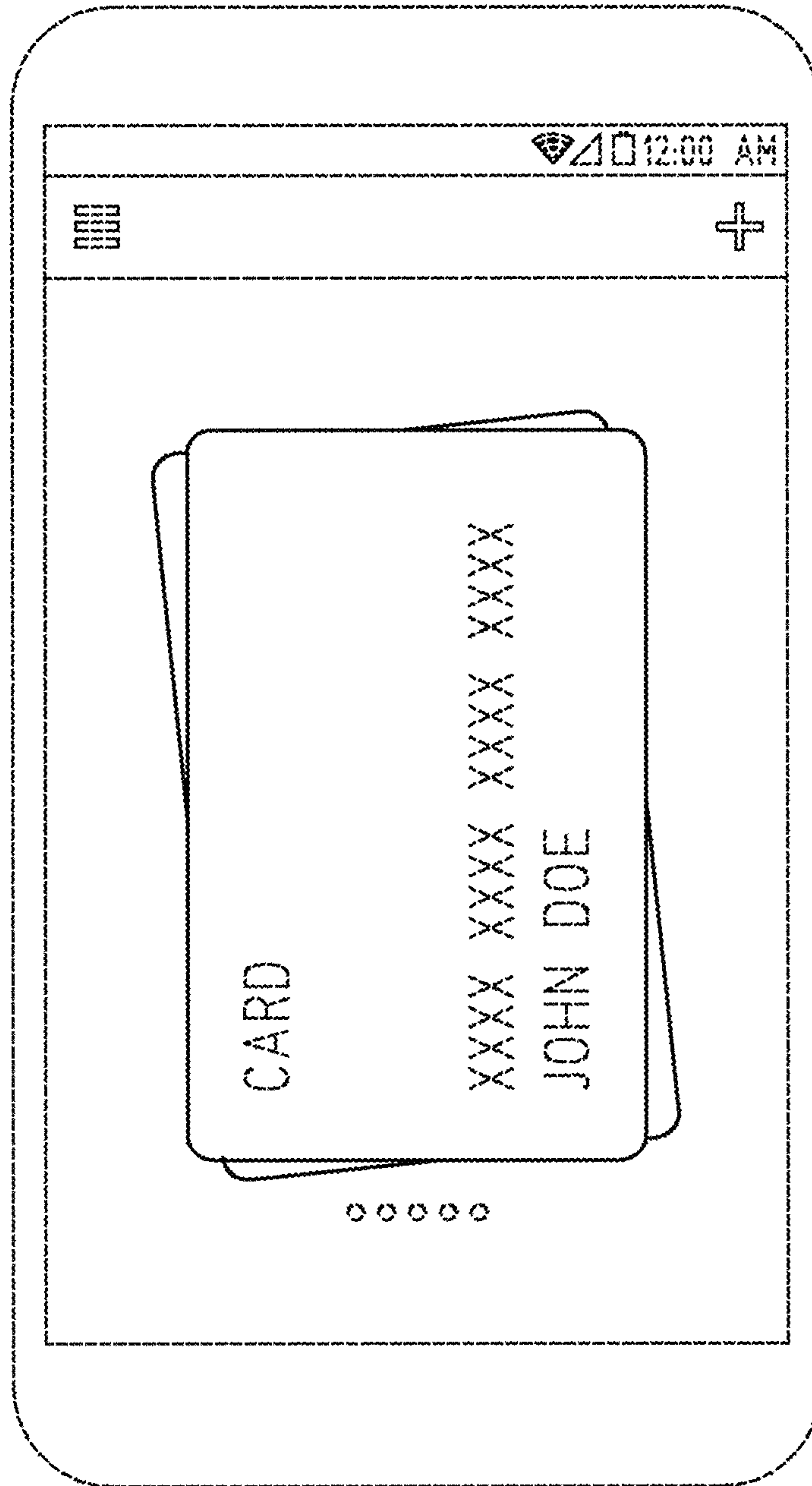

FIG. 1

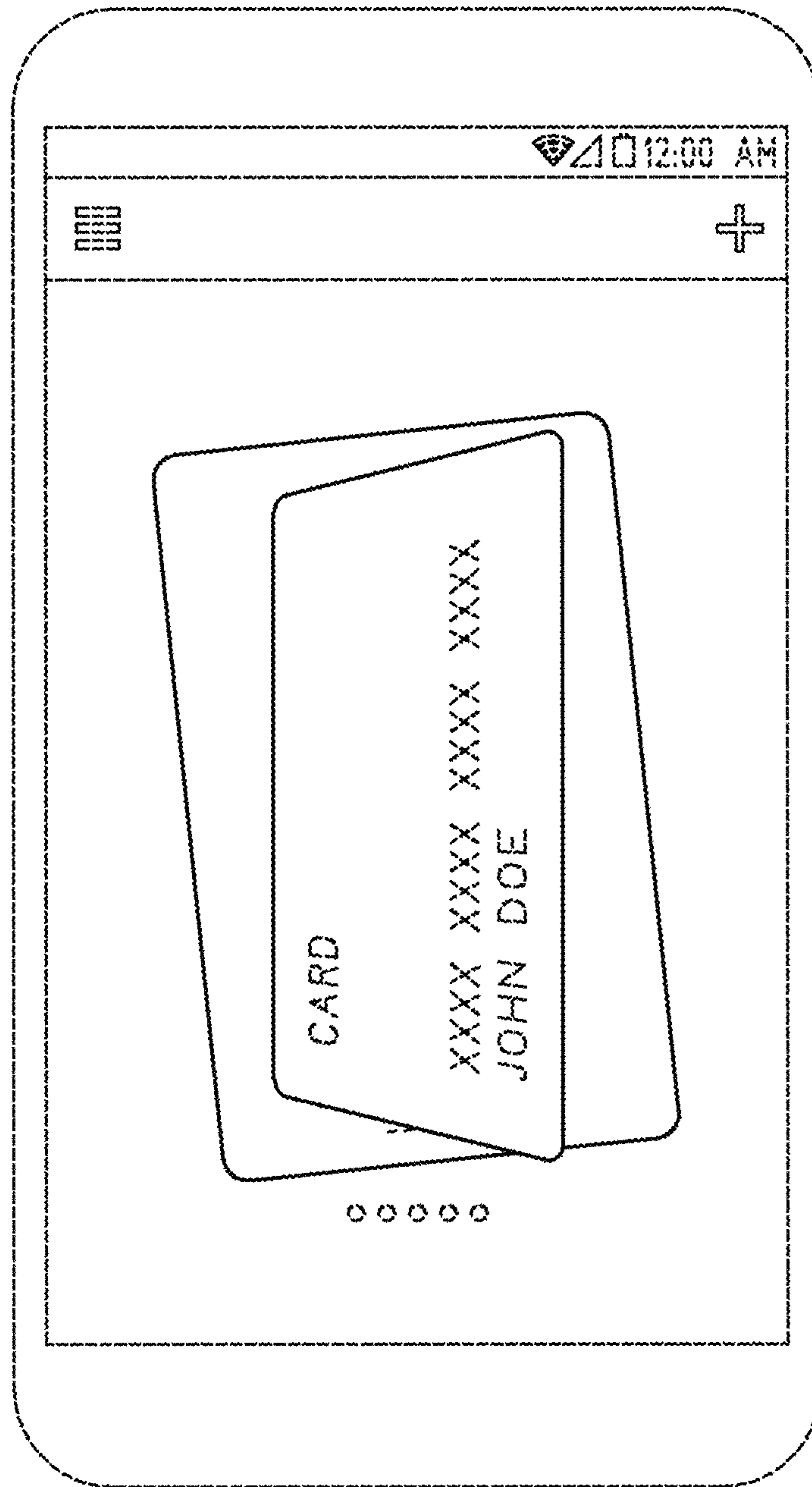

FIG. 2

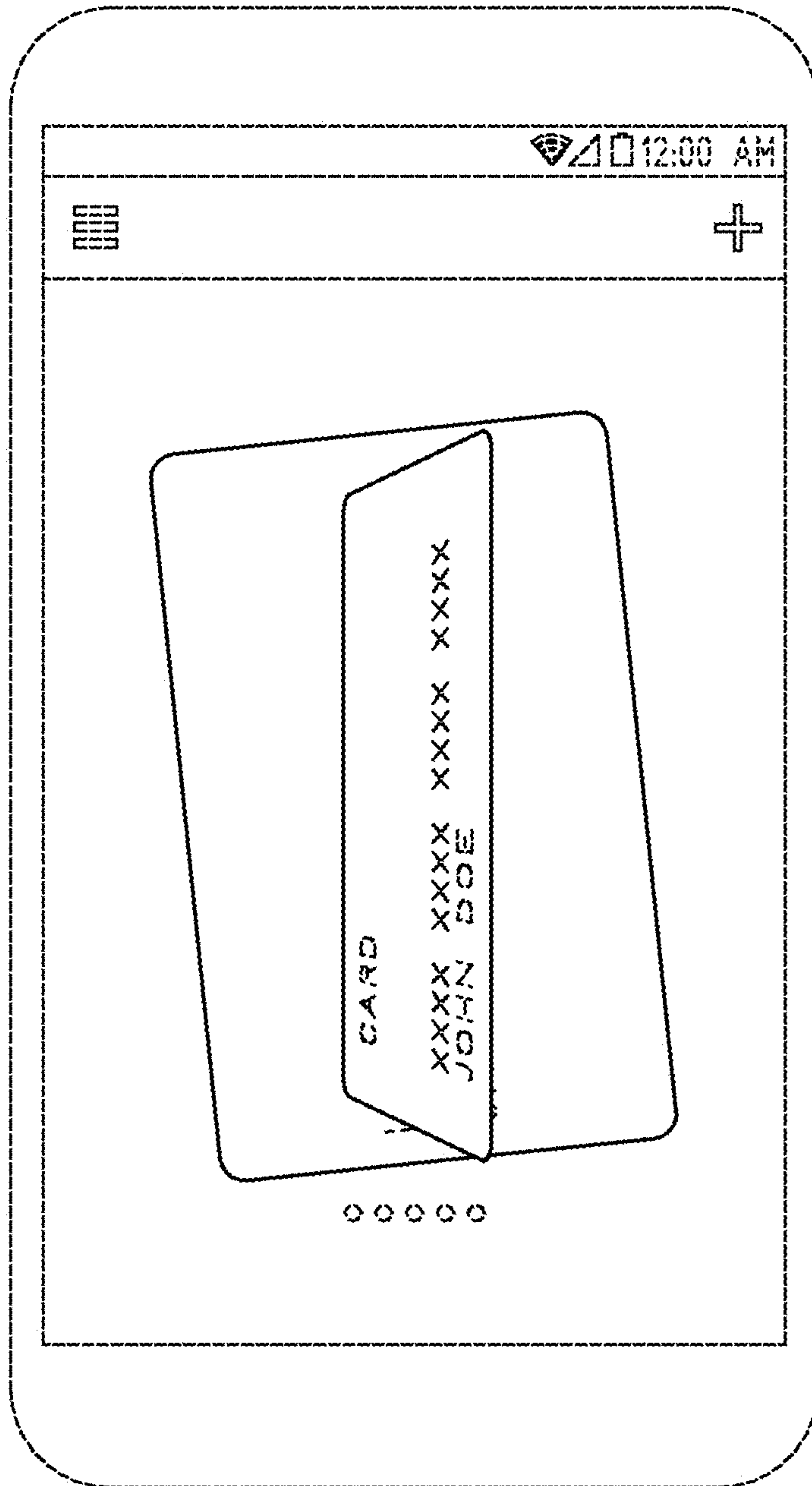

FIG. 3

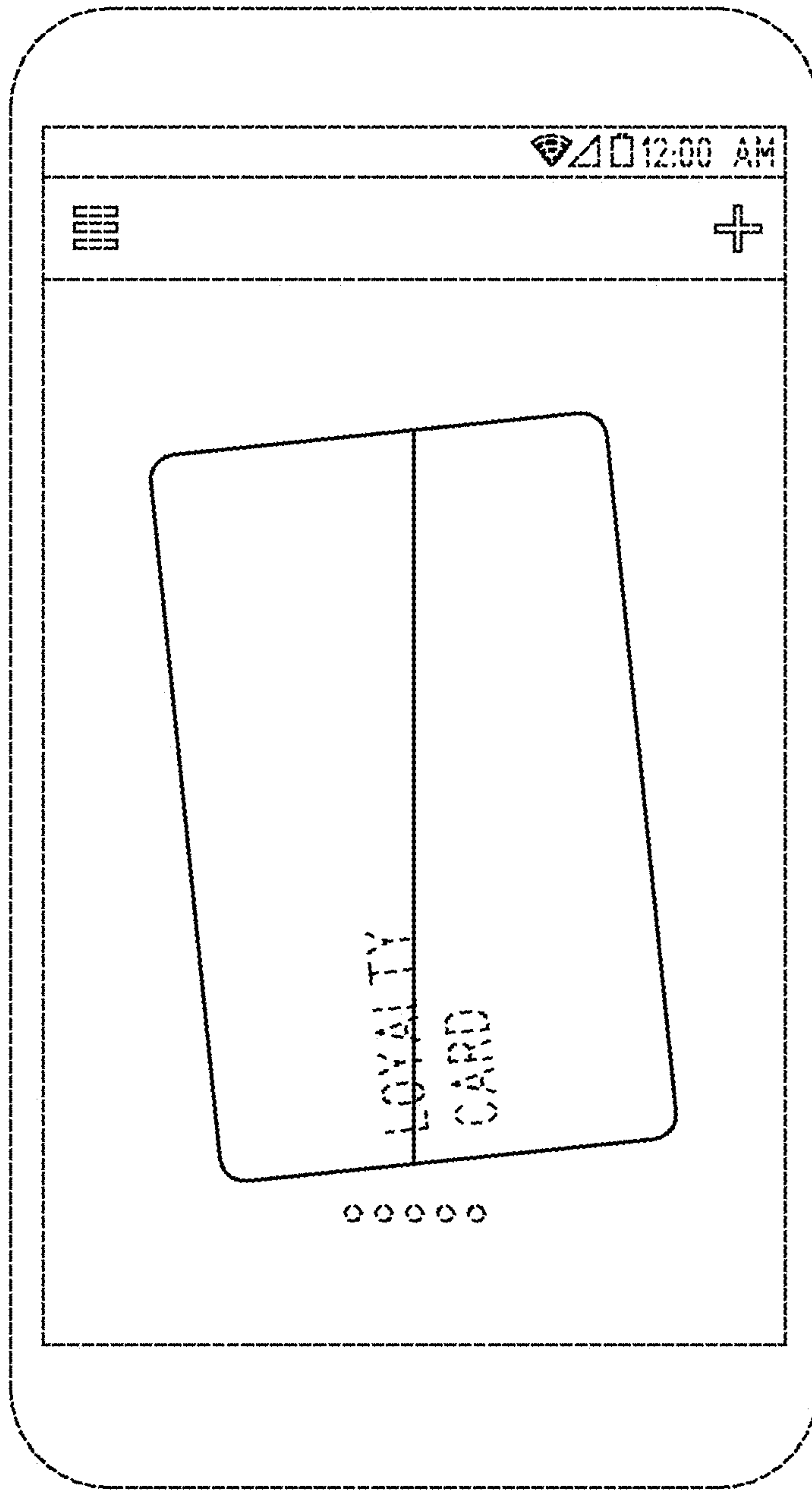

FIG. 4

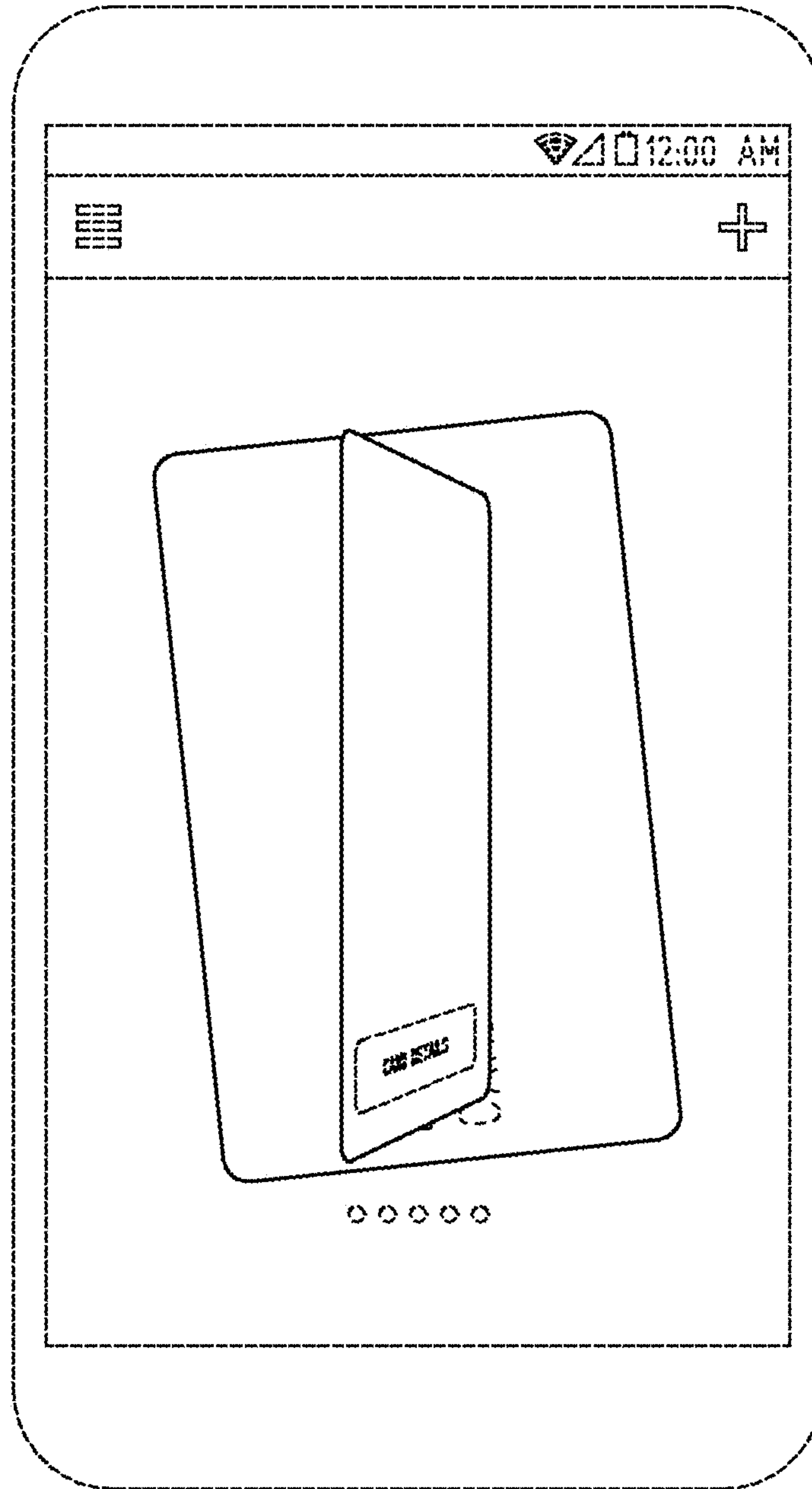

FIG. 5

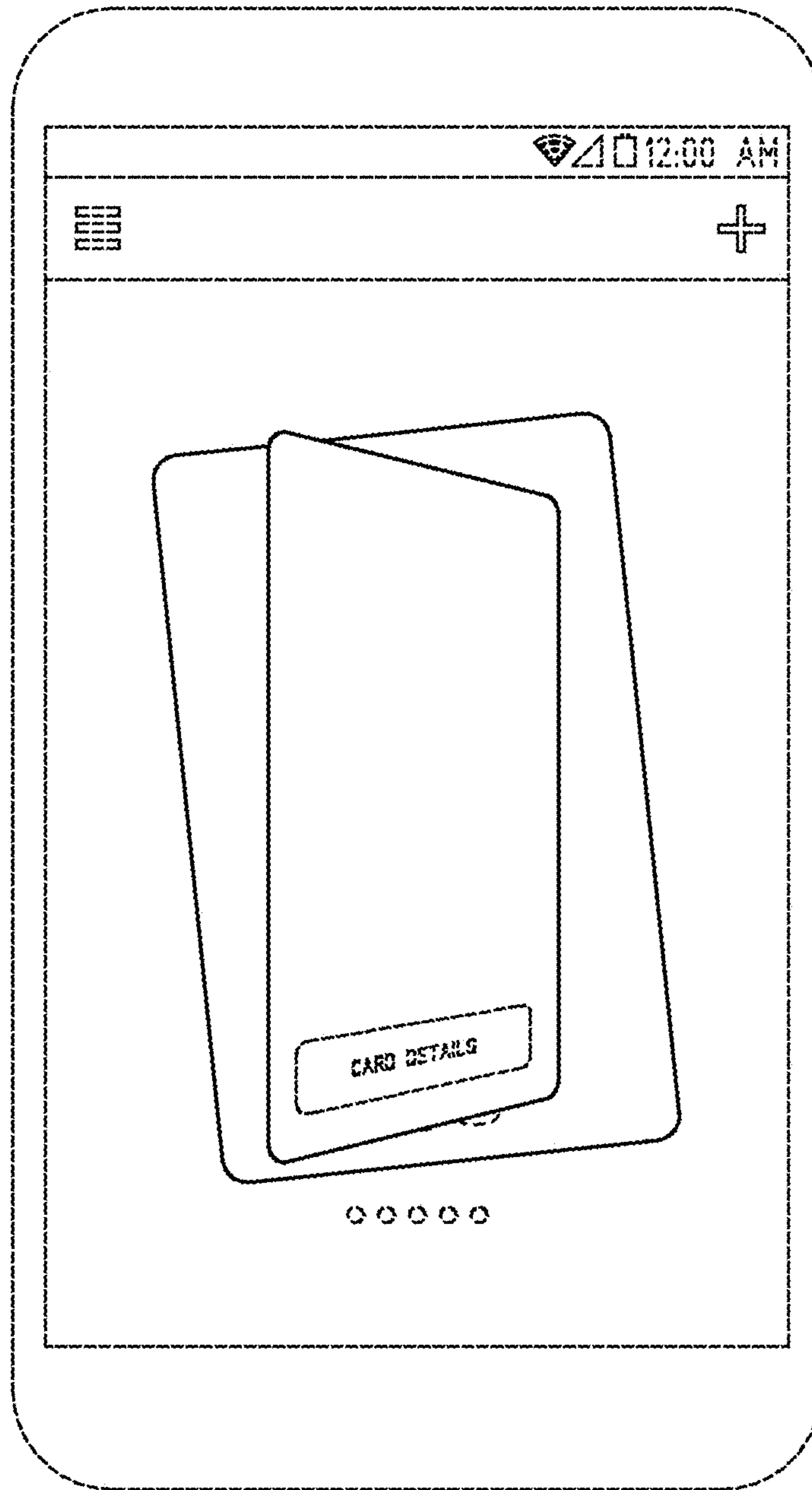

FIG. 6

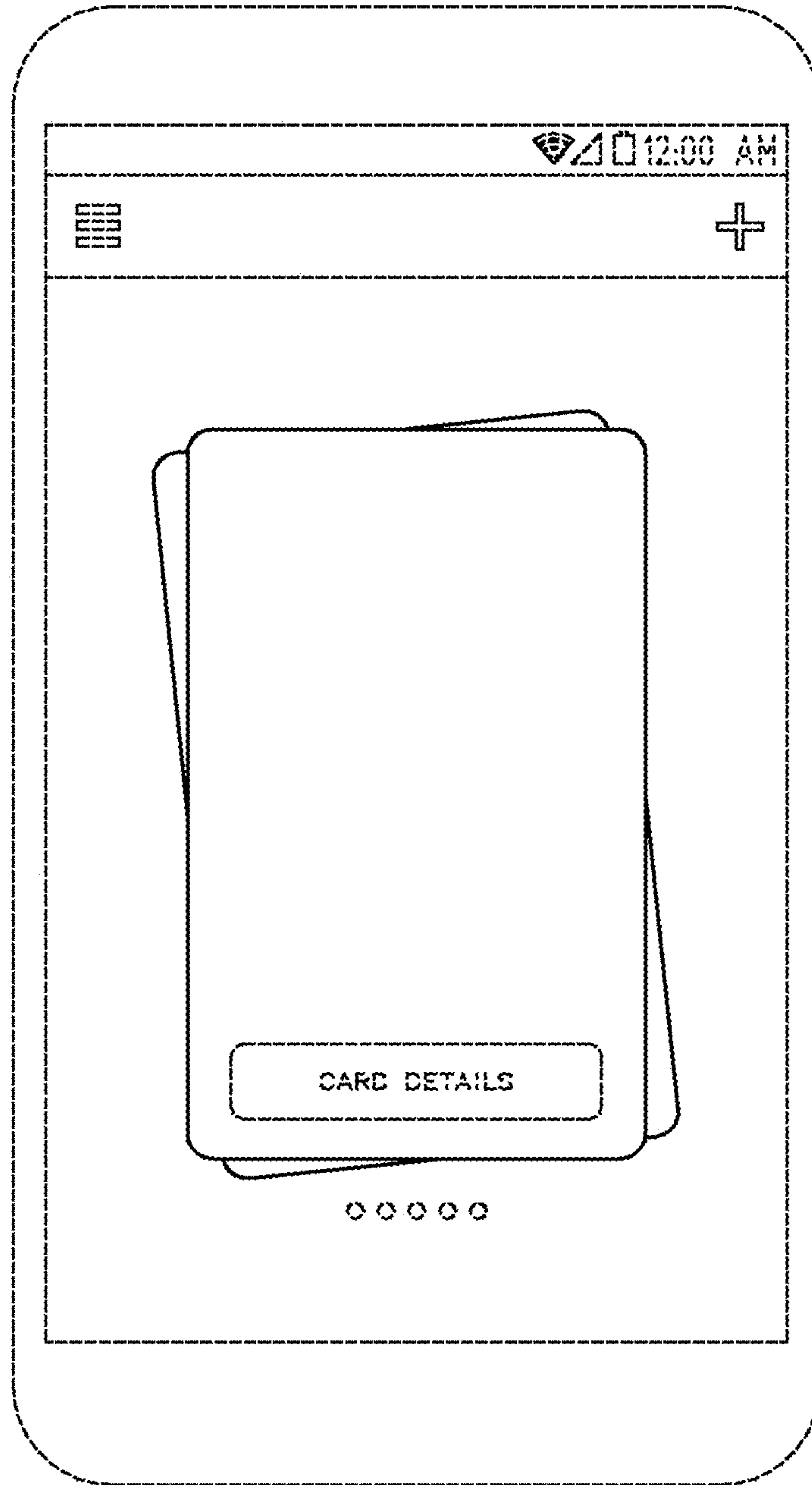

FIG. 7

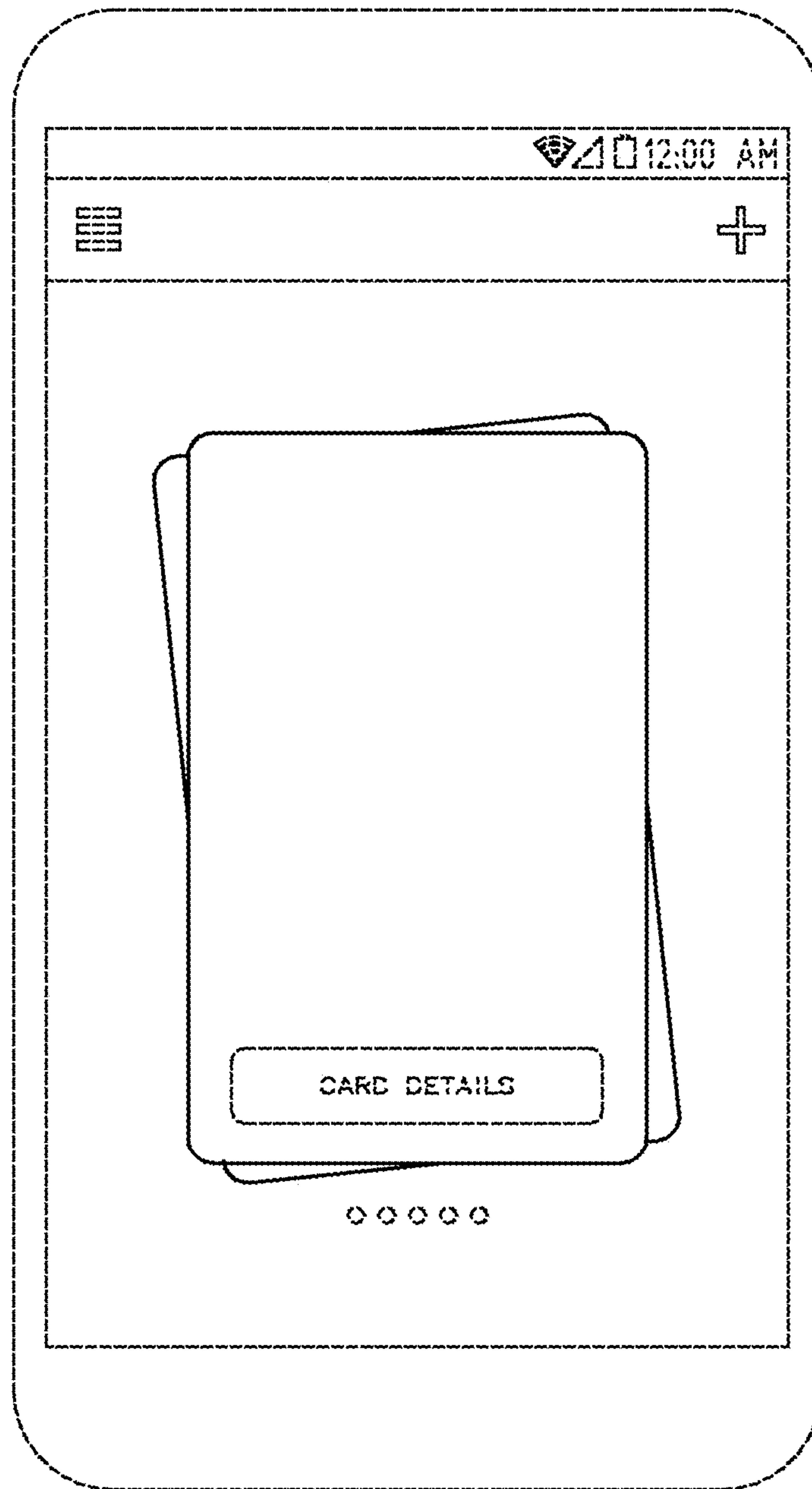

FIG. 8

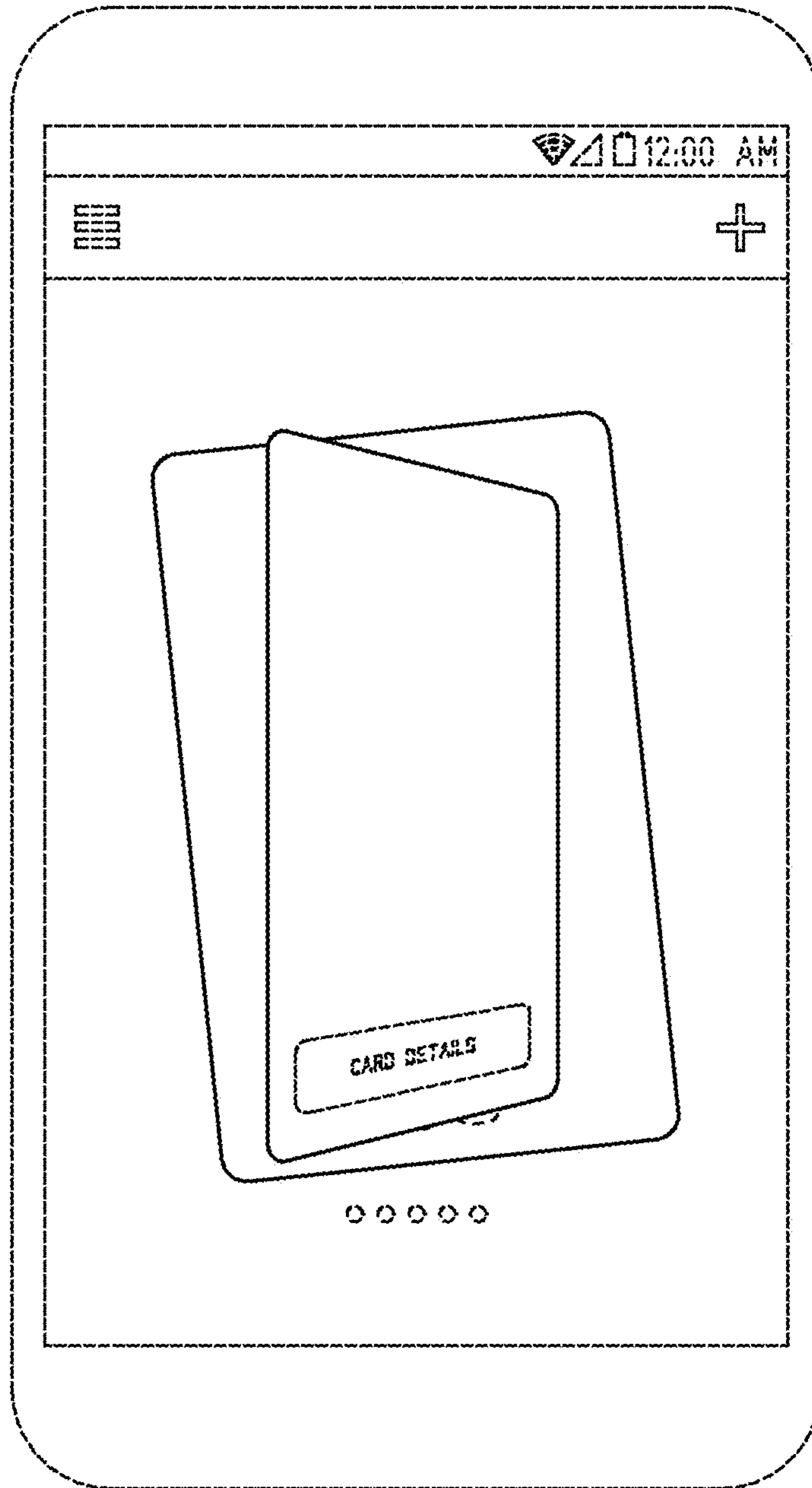

FIG. 9

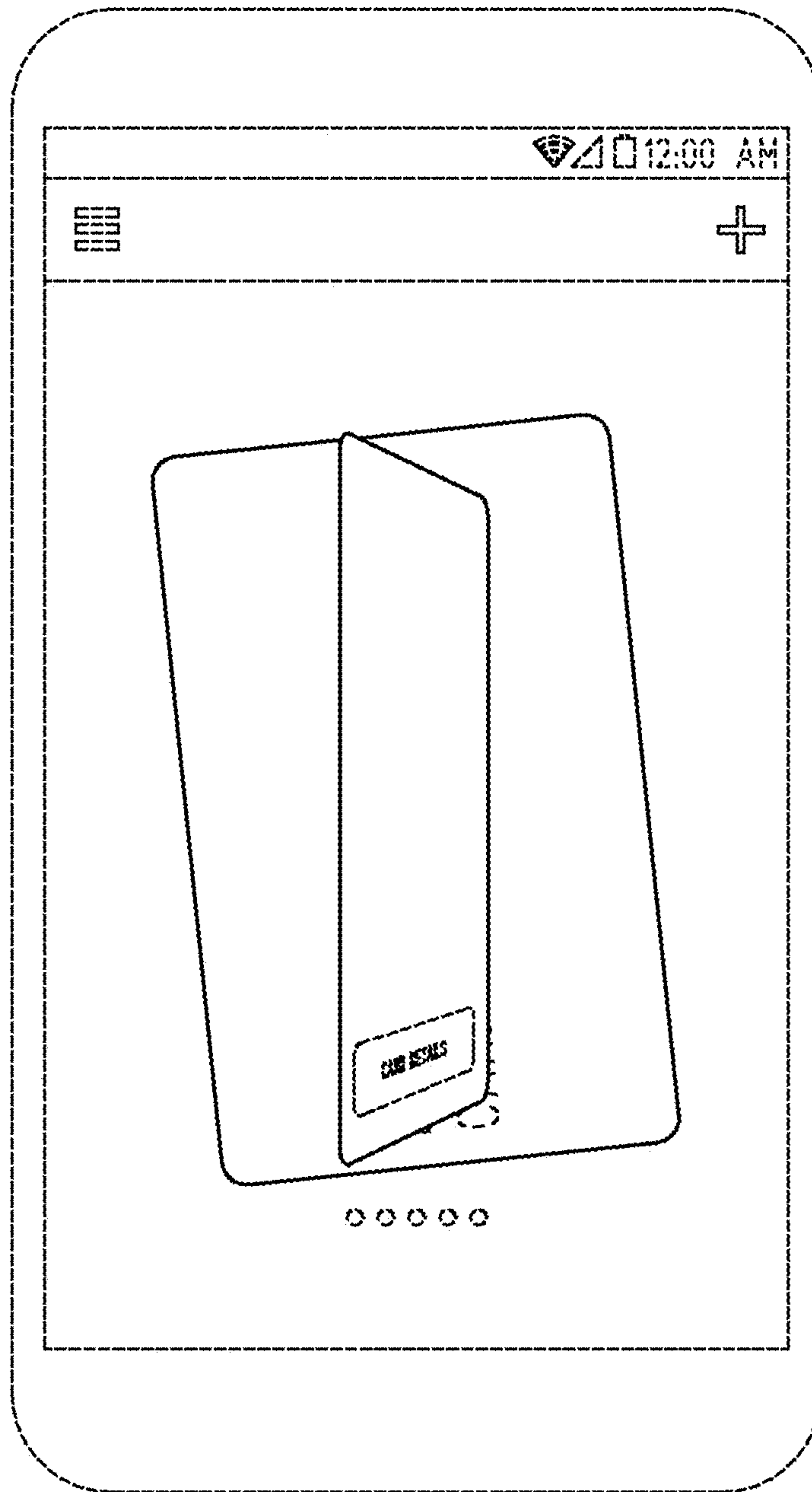

FIG. 10

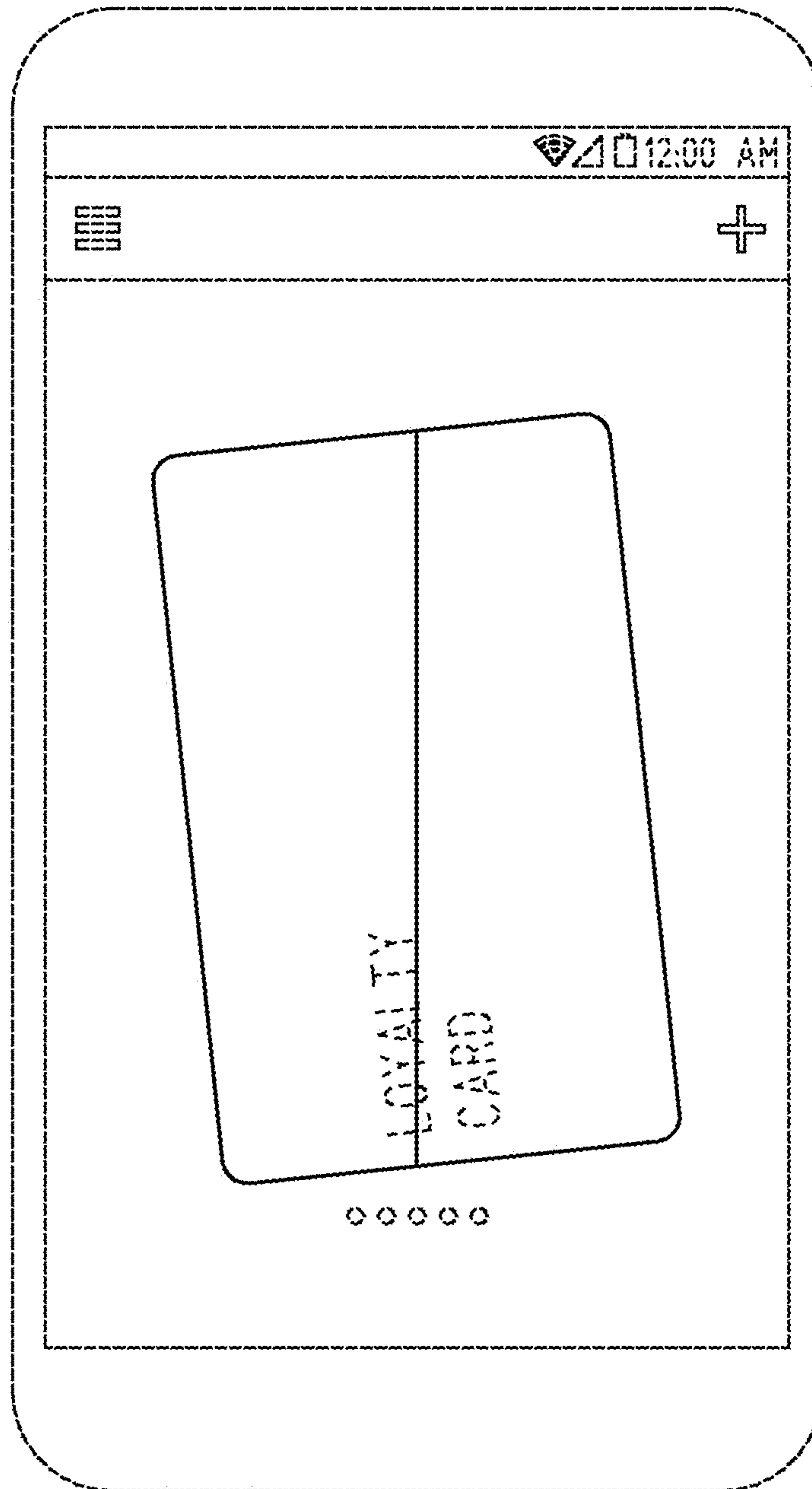

FIG. 11

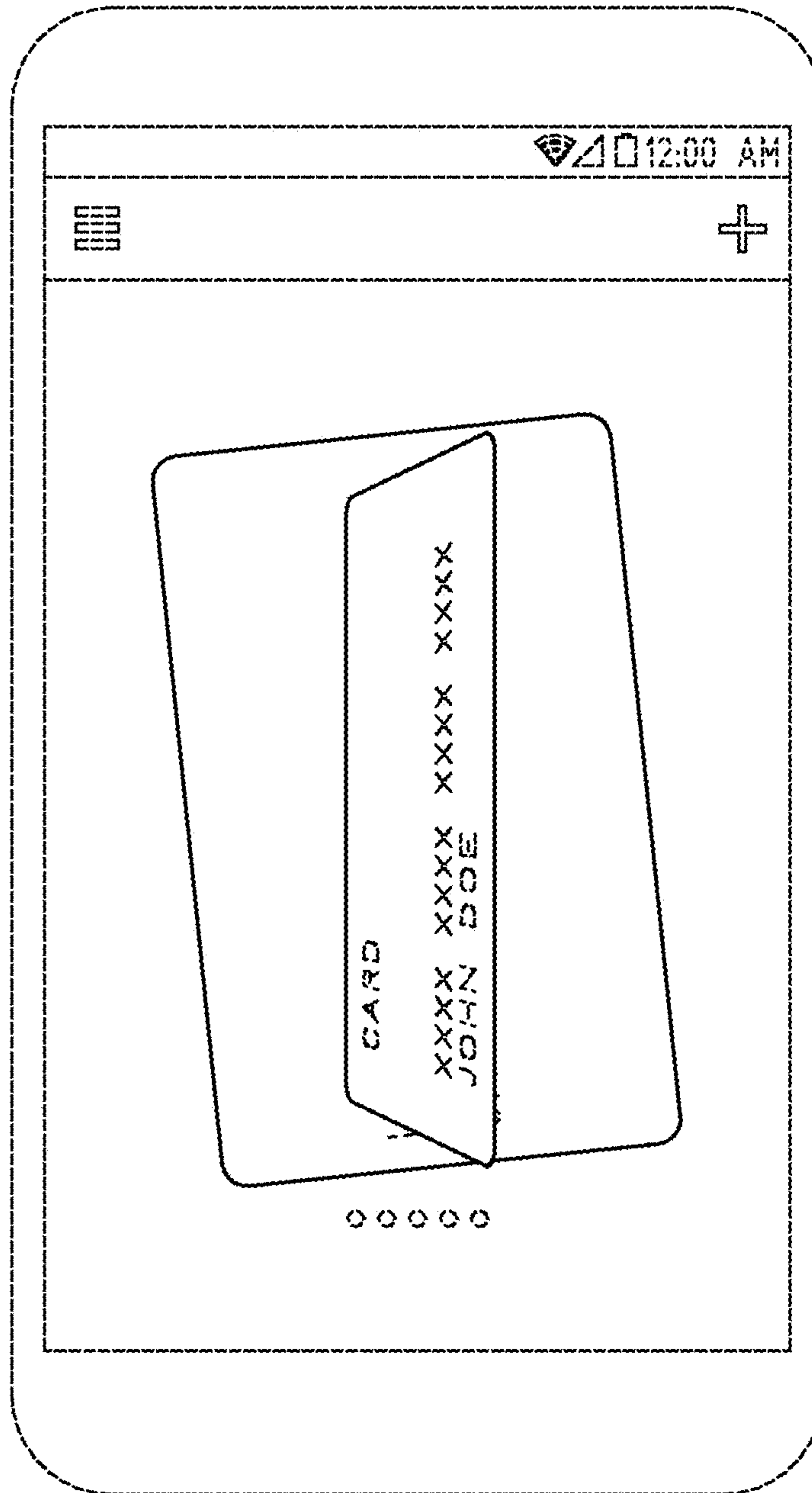

FIG. 12

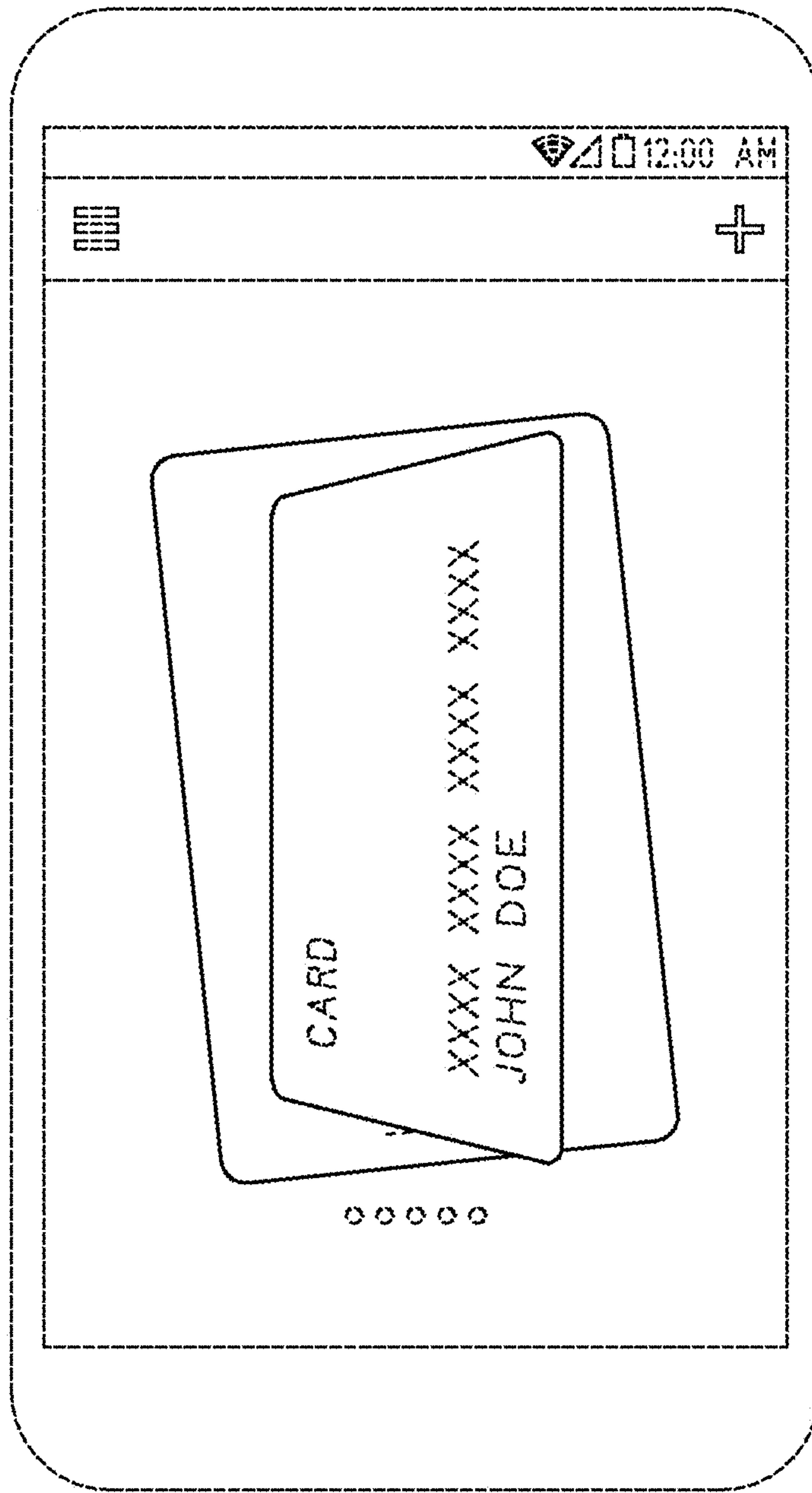

FIG. 13

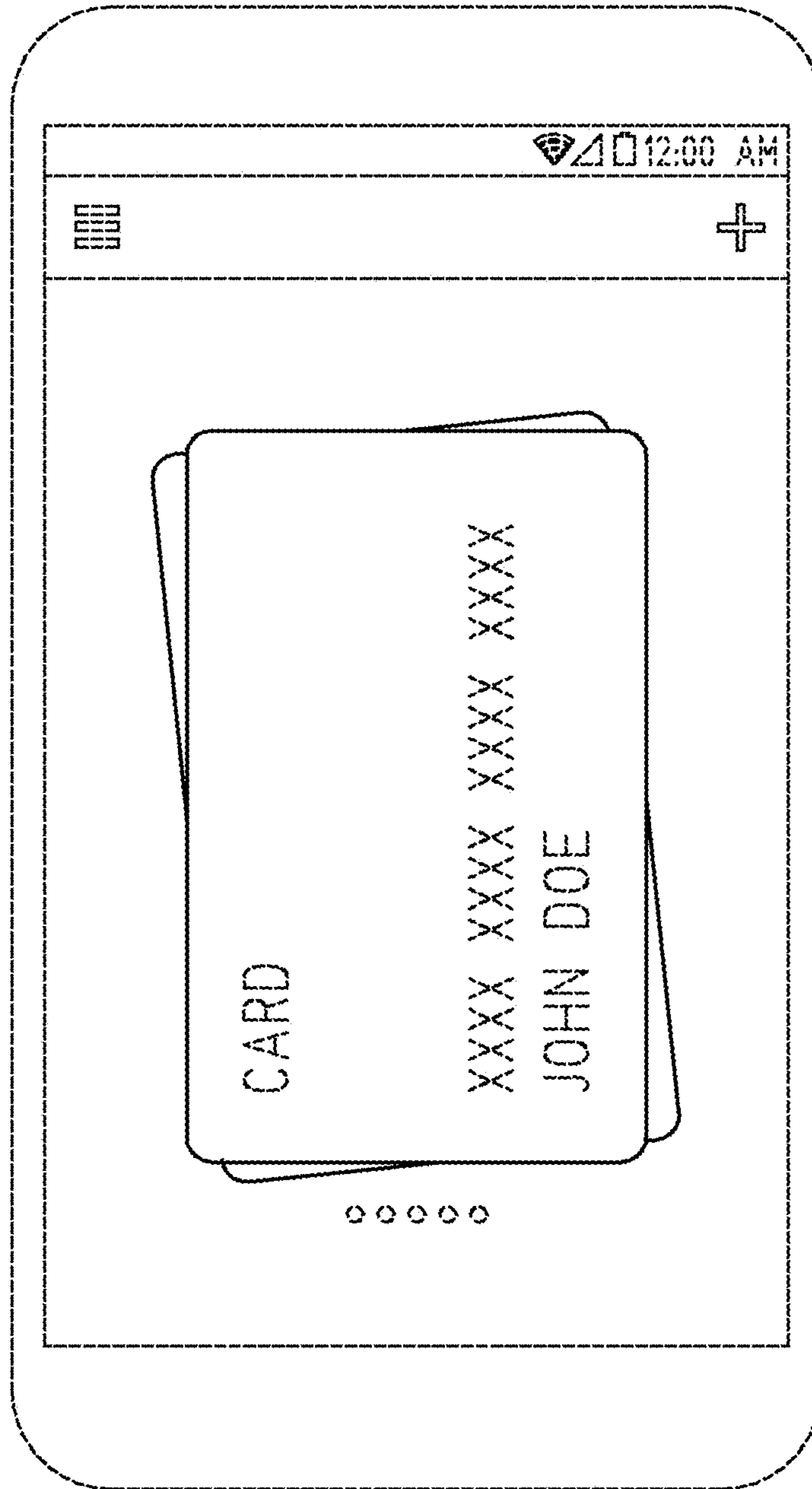

FIG. 14