

US00D784983S

(12) **United States Design Patent** (10) **Patent No.:** **US D784,983 S**
Kim et al. (45) **Date of Patent:** **** Apr. 25, 2017**

(54) **MONITOR**

(71) Applicant: **LG ELECTRONICS INC.**, Seoul (KR)

(72) Inventors: **Sungjoo Kim**, Seoul (KR); **Bumsang Lee**, Seoul (KR)

(73) Assignee: **LG Electronics Inc.**, Seoul (KR)

(**) Term: **15 Years**

(21) Appl. No.: **29/551,702**

(22) Filed: **Jan. 15, 2016**

(30) **Foreign Application Priority Data**

Jul. 17, 2015 (KR) 30-2015-0036279

(51) **LOC (10) Cl.** **14-02**

(52) **U.S. Cl.**
USPC **D14/374**

(58) **Field of Classification Search**

USPC D14/371-375, 125-129, 336, 337, 341, D14/239; 341/12; 345/104, 156, 168, 345/173; 348/180, 184, 325, 739; 349/1, 349/2, 11, 62; 361/679.05-679.07, 361/679.21; D6/300, 308

CPC G06F 1/16; G06F 1/1601; G06F 3/037; G06F 1/162; G06F 1/1613; G06F 1/133308; F16M 11/02; F16M 11/10; F16M 11/00; F16M 11/06; F16M 11/18; F16M 11/045; F16M 11/105

See application file for complete search history.

(56) **References Cited**

U.S. PATENT DOCUMENTS

D545,778 S *	7/2007	Isshiki	D14/126
D558,743 S *	1/2008	Isshiki	D14/239
D562,788 S *	2/2008	Asanuma	D14/126
D566,669 S *	4/2008	Ooshima	D14/126
D570,312 S *	6/2008	Kita	D14/126
D619,135 S *	7/2010	Lin	D14/374
D634,324 S *	3/2011	Park	D14/374
D659,661 S *	5/2012	Lim	D14/126
D686,615 S *	7/2013	Lee	D14/374

* cited by examiner

Primary Examiner — Freda S Nunn

(74) *Attorney, Agent, or Firm* — Birch, Stewart, Kolasch & Birch, LLP

(57) **CLAIM**

The ornamental design for a monitor, as shown and described.

DESCRIPTION

FIG. 1 is a front, right side, perspective view of a monitor showing our new design;
 FIG. 2 is a front view thereof;
 FIG. 3 is a rear view thereof;
 FIG. 4 is a left side view thereof;
 FIG. 5 is a right side view thereof;
 FIG. 6 is a top view thereof; and,
 FIG. 7 is a bottom view thereof.

1 Claim, 5 Drawing Sheets

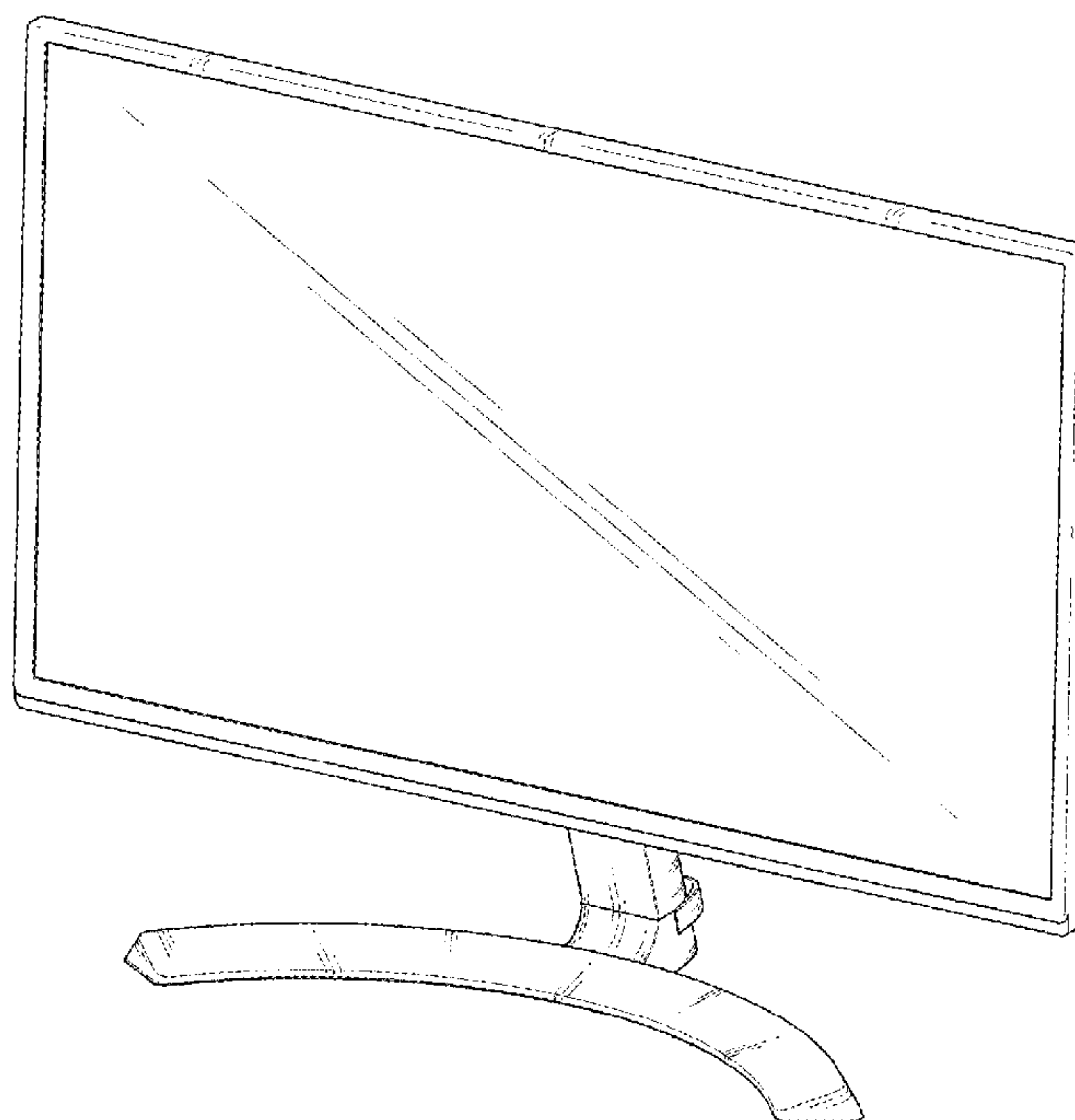

FIG. 1

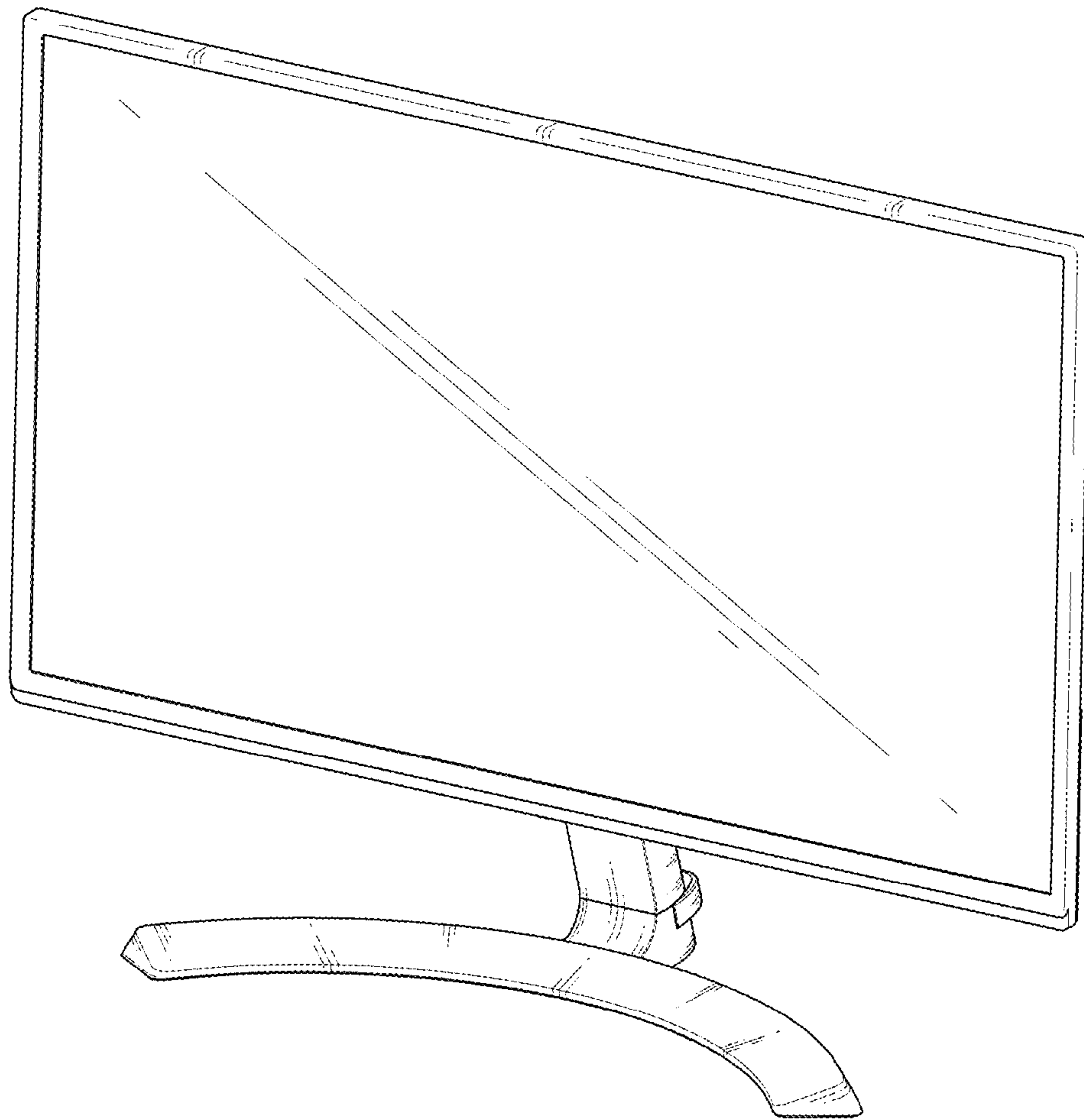

FIG. 2

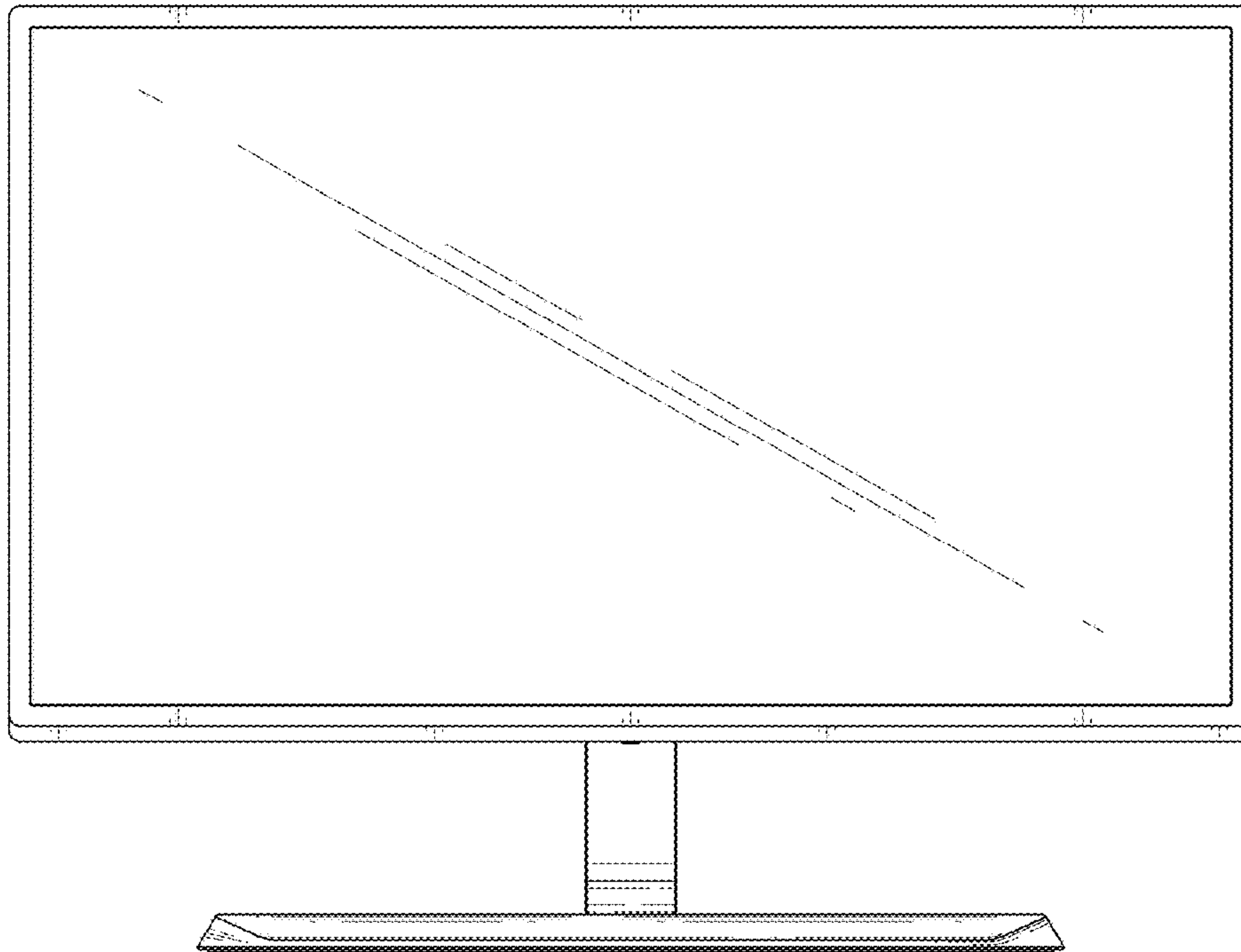

FIG. 3

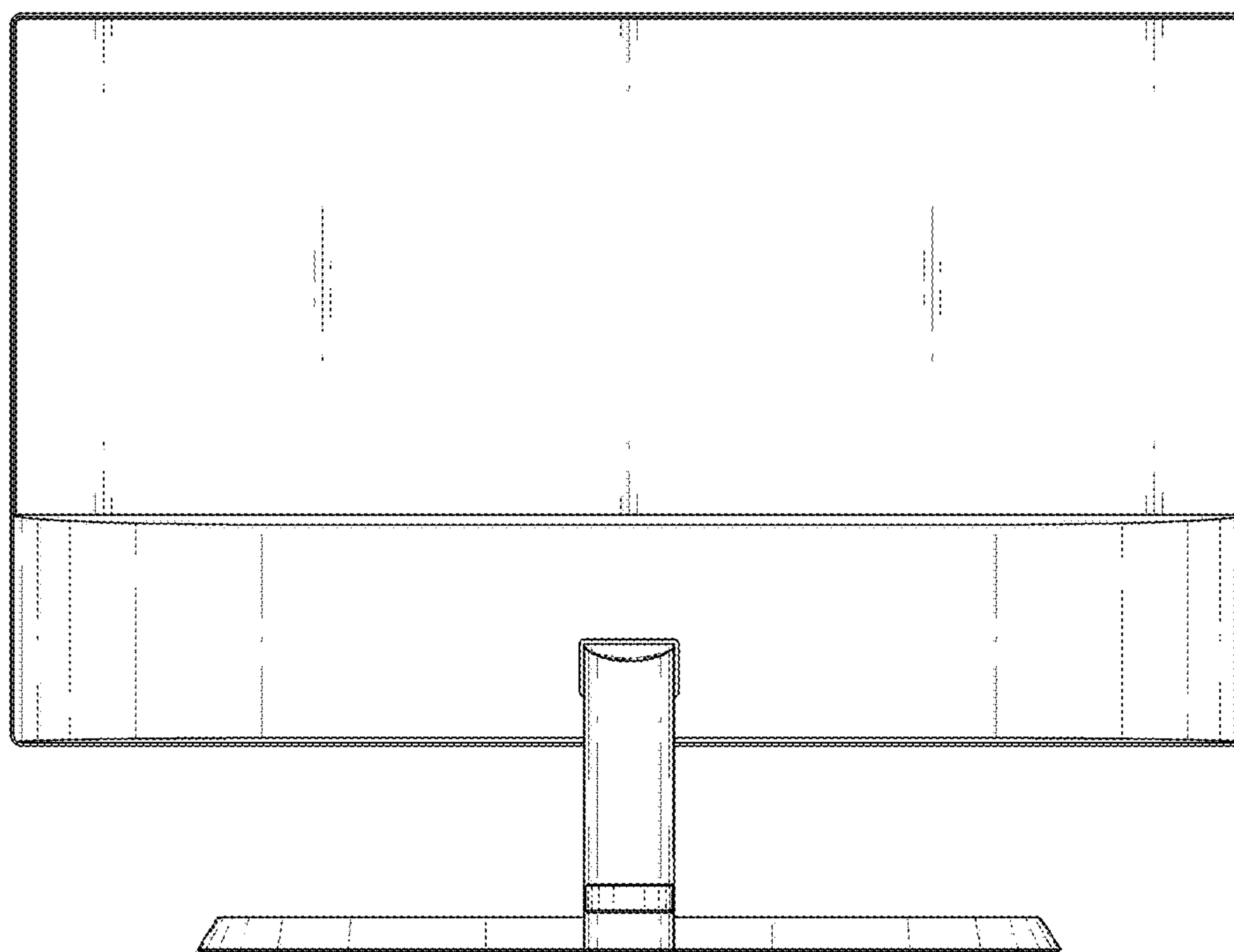

FIG. 4

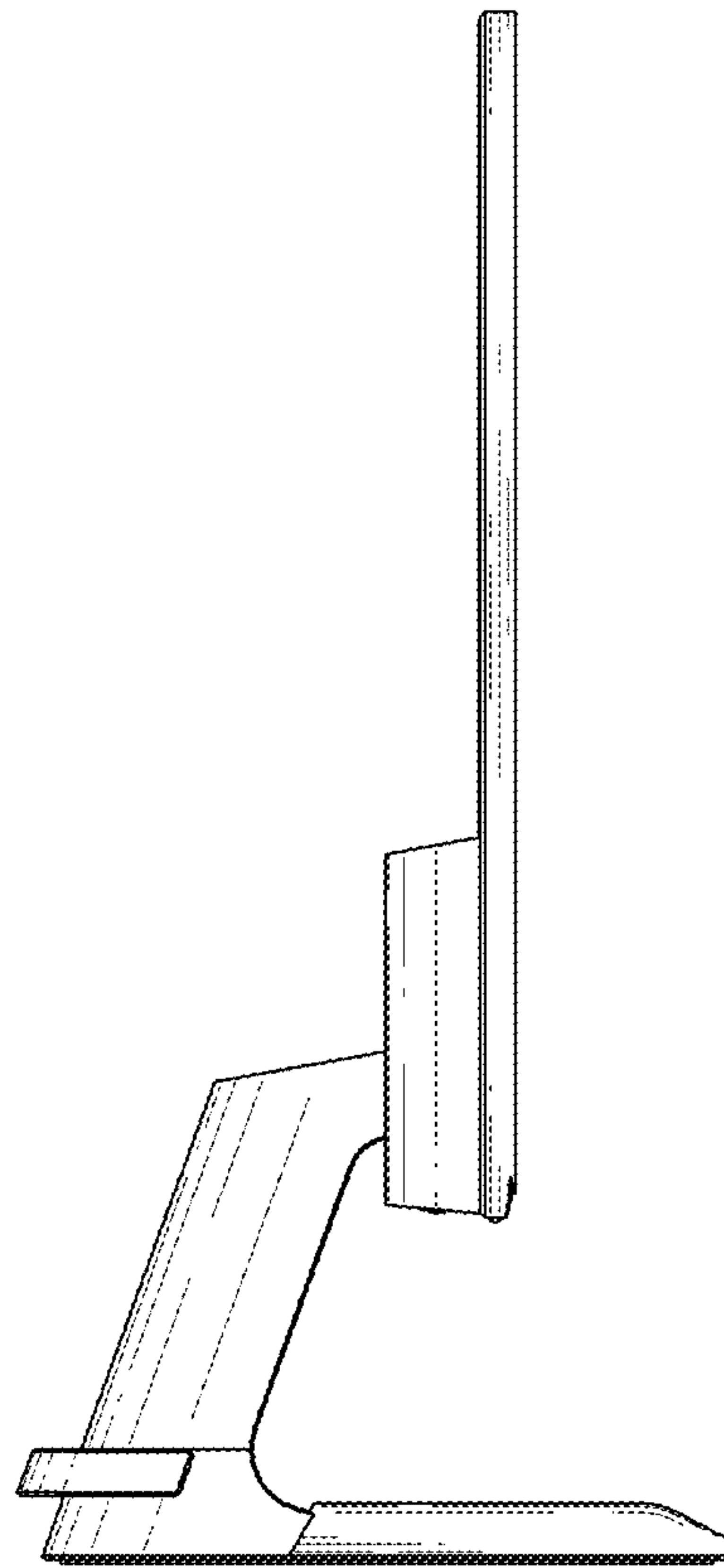

FIG. 5

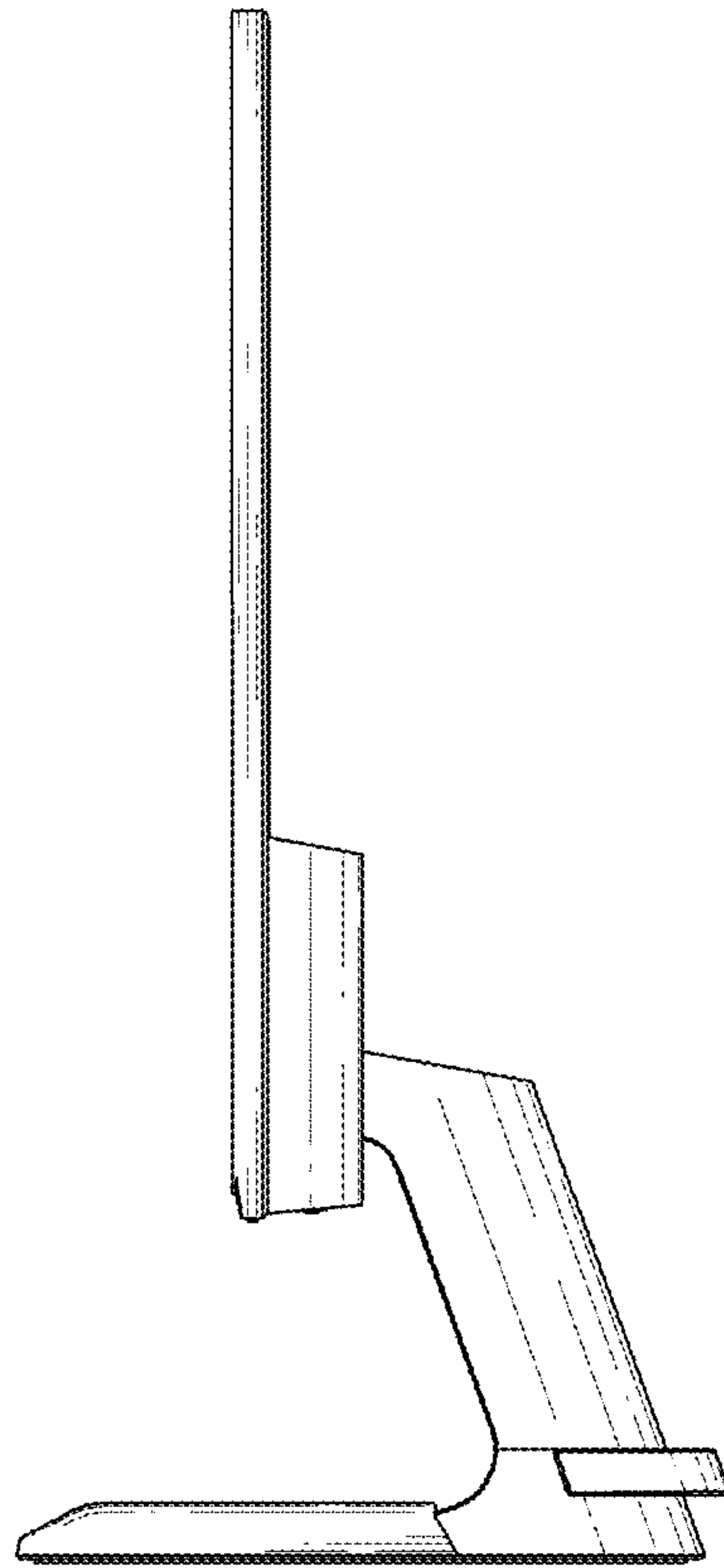

FIG. 6

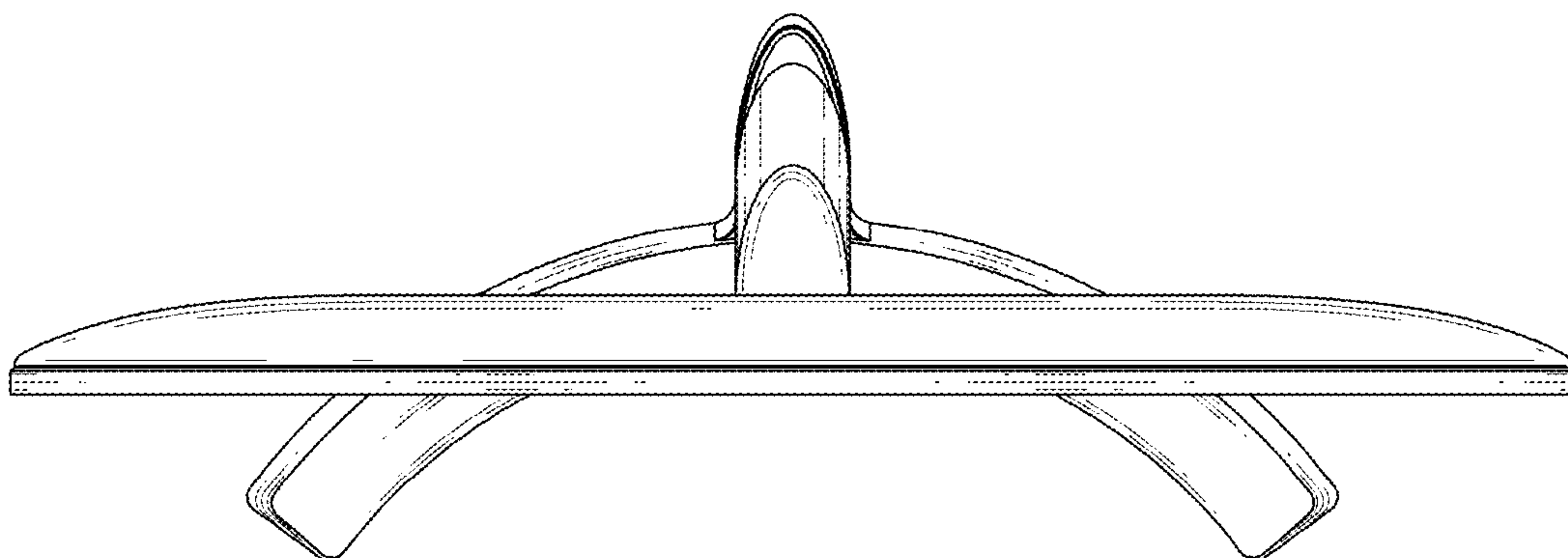

FIG. 7

