



US00D784953S

(12) **United States Design Patent** (10) **Patent No.:** **US D784,953 S**
Warden (45) **Date of Patent:** **** Apr. 25, 2017**

(54) **LOUDSPEAKER**

(56) **References Cited**

(71) Applicant: **Bose Corporation**, Framingham, MA (US)

U.S. PATENT DOCUMENTS

(72) Inventor: **Robert A. Warden**, Southborough, MA (US)

D372,918 S * 8/1996 Manganese D14/204
D408,297 S * 4/1999 Hargrove, III D10/1
D571,749 S * 6/2008 Barnett D14/126
7,516,932 B2 * 4/2009 Engebretson H04R 1/026
248/317

(73) Assignee: **Bose Corporation**, Framingham, MA (US)

D594,854 S * 6/2009 Hawkins D14/217
D622,258 S * 8/2010 Joseph D10/2
D659,670 S * 5/2012 Goetzen D14/194
D663,719 S * 7/2012 Warden D14/214
D681,010 S * 4/2013 Cho D14/215

(**) Term: **15 Years**

* cited by examiner

(21) Appl. No.: **29/559,583**

Primary Examiner — Ian Simmons

(22) Filed: **Mar. 30, 2016**

Assistant Examiner — Janice Lim

(74) *Attorney, Agent, or Firm* — Bose Corporation

Related U.S. Application Data

(62) Division of application No. 29/493,734, filed on Jun. 12, 2014, now Pat. No. Des. 756,328.

(57) **CLAIM**

The ornamental design for a loudspeaker, substantially as shown and described.

(51) **LOC (10) Cl.** **14-01**

DESCRIPTION

(52) **U.S. Cl.**

USPC **D14/204**

(58) **Field of Classification Search**

USPC D14/167, 170–172, 194–196, 204, 207, D14/209.1, 210–216, 221, 222; 181/143, 181/144, 147, 148, 150, 151, 153, 157, 181/198, 199; 381/300–302, 306, 332, 381/333, 336, 345, 361–364, 386–388
CPC H04R 1/02; H04R 1/021; H04R 1/023; H04R 5/00; H04R 9/06; H04R 2420/07

FIG. 1 is a top, front, and right side perspective view of a loudspeaker, showing my new design;
FIG. 2 is a front view thereof;
FIG. 3 is a back view thereof;
FIG. 4 is a top plan view thereof;
FIG. 5 is a bottom plan view thereof;
FIG. 6 is a left side view thereof; and,
FIG. 7 is a right side view thereof.

See application file for complete search history.

1 Claim, 6 Drawing Sheets

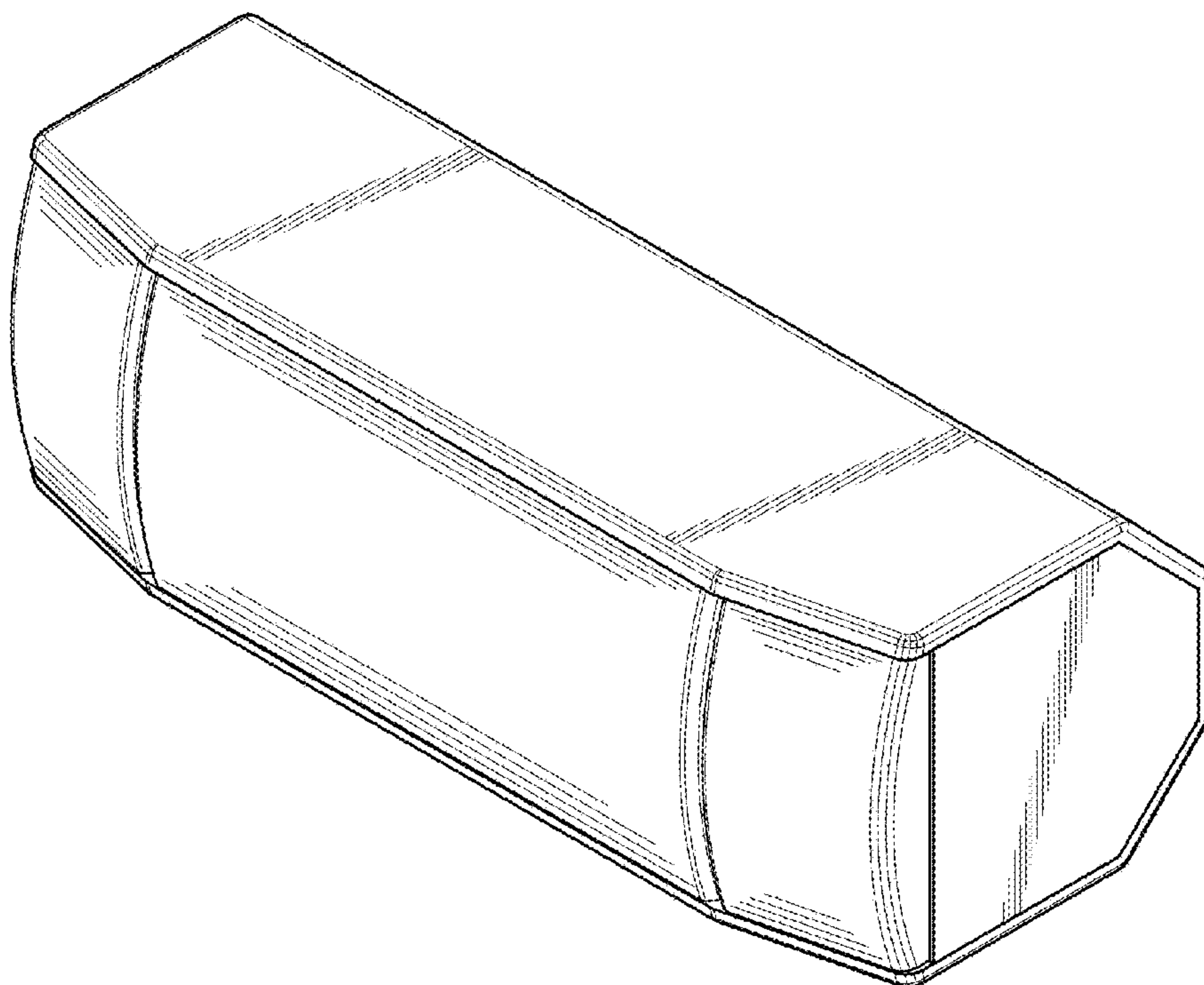

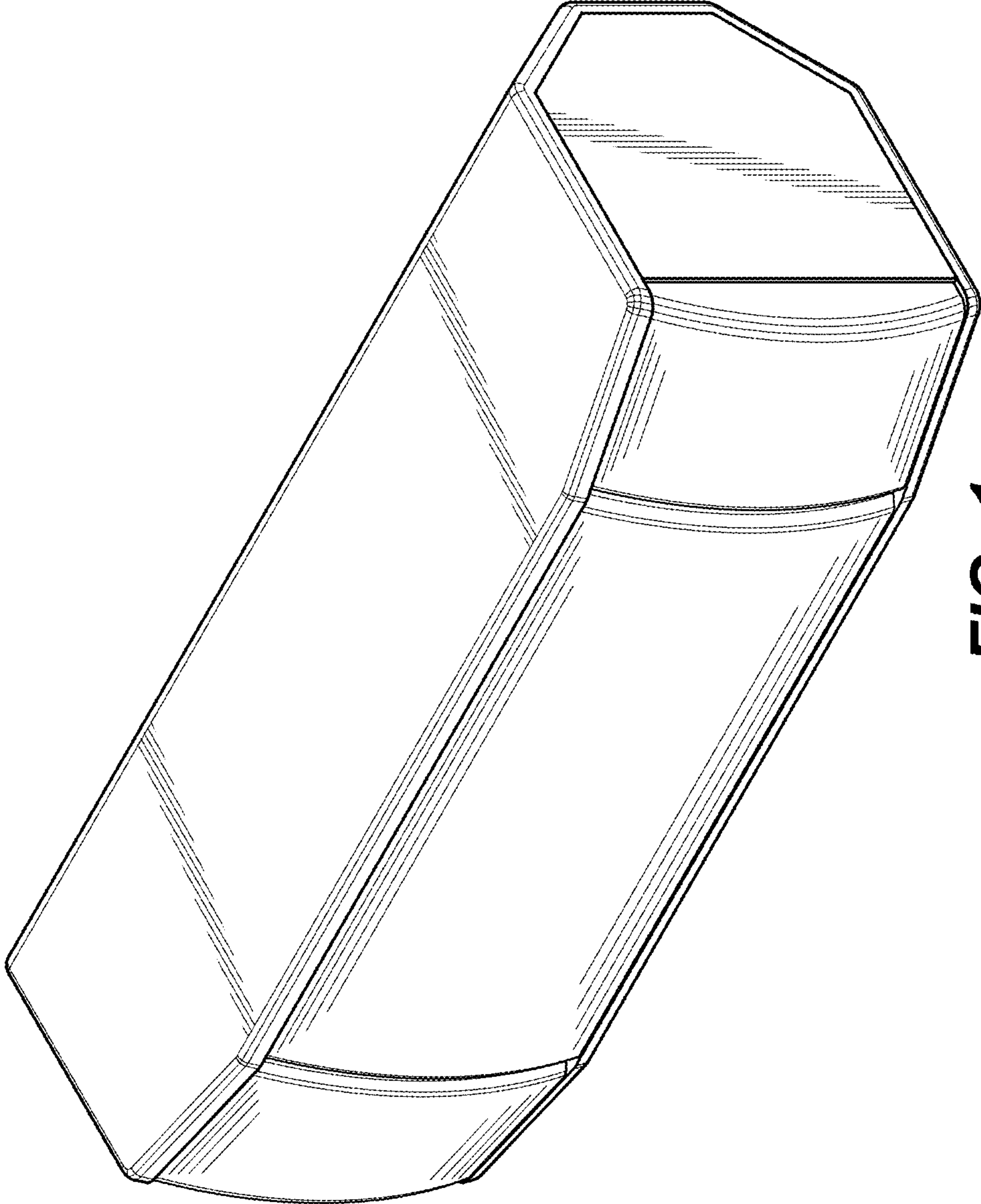

FIG. 1

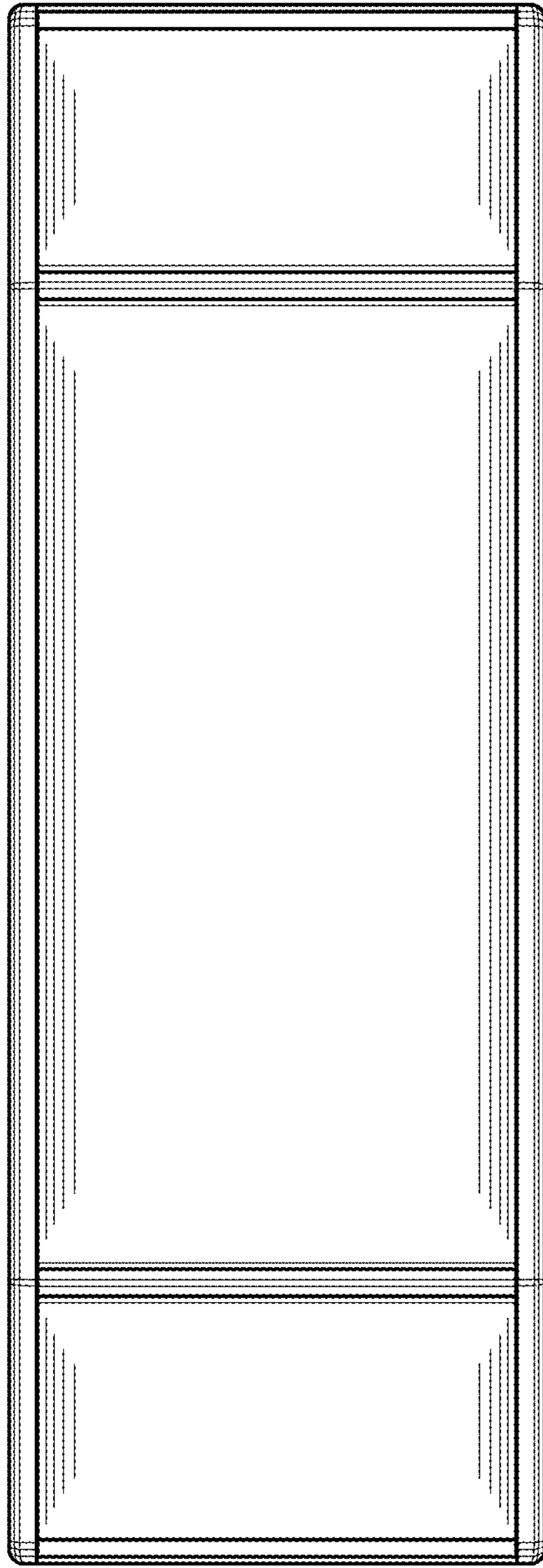

FIG. 2

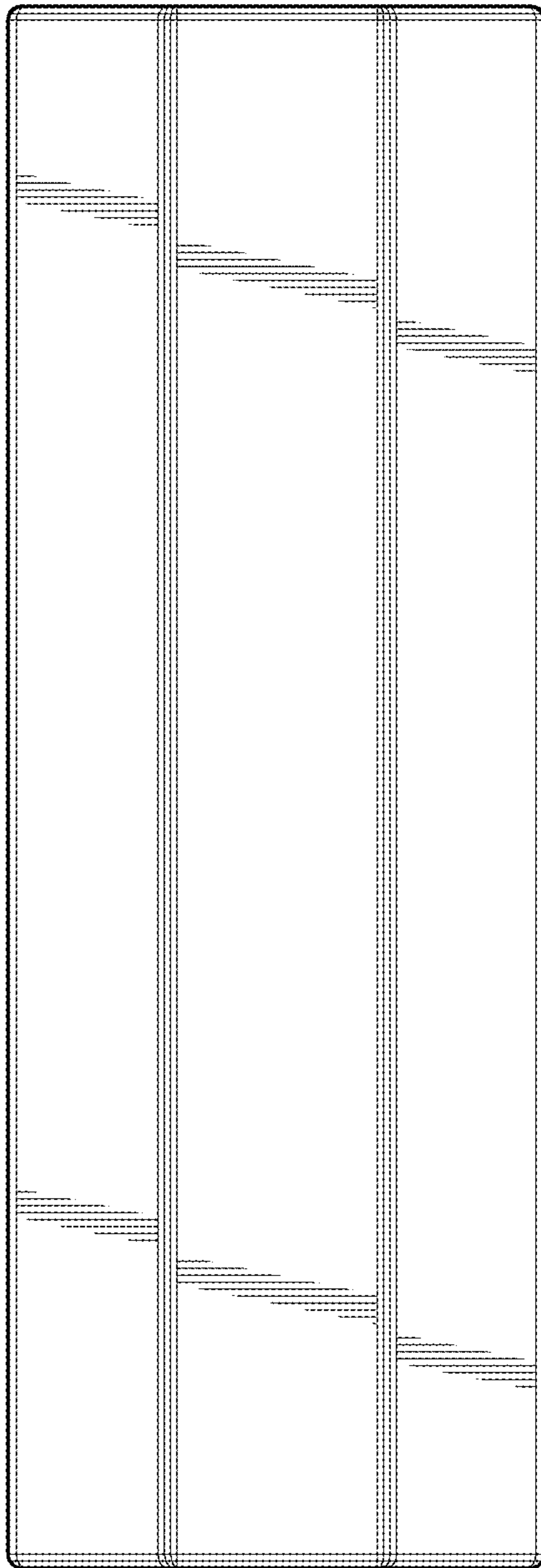

FIG. 3

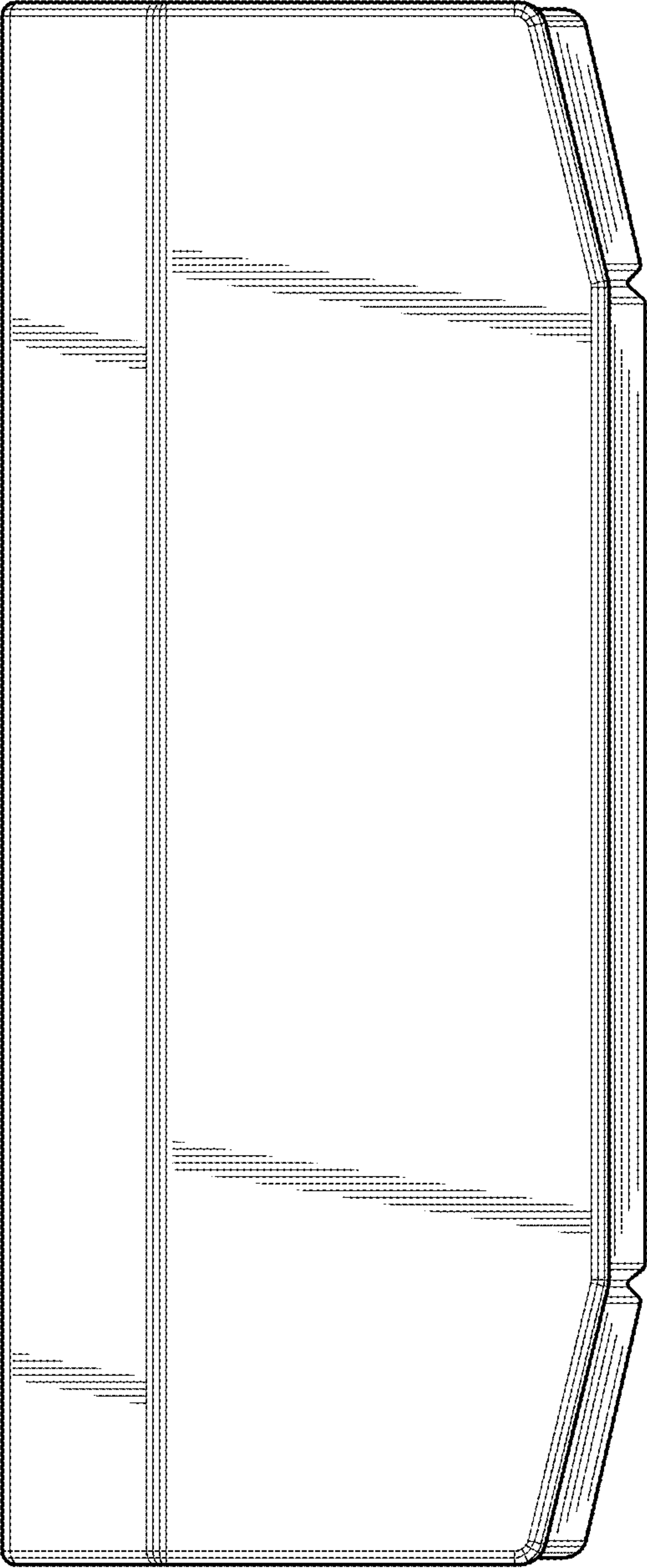

FIG. 4

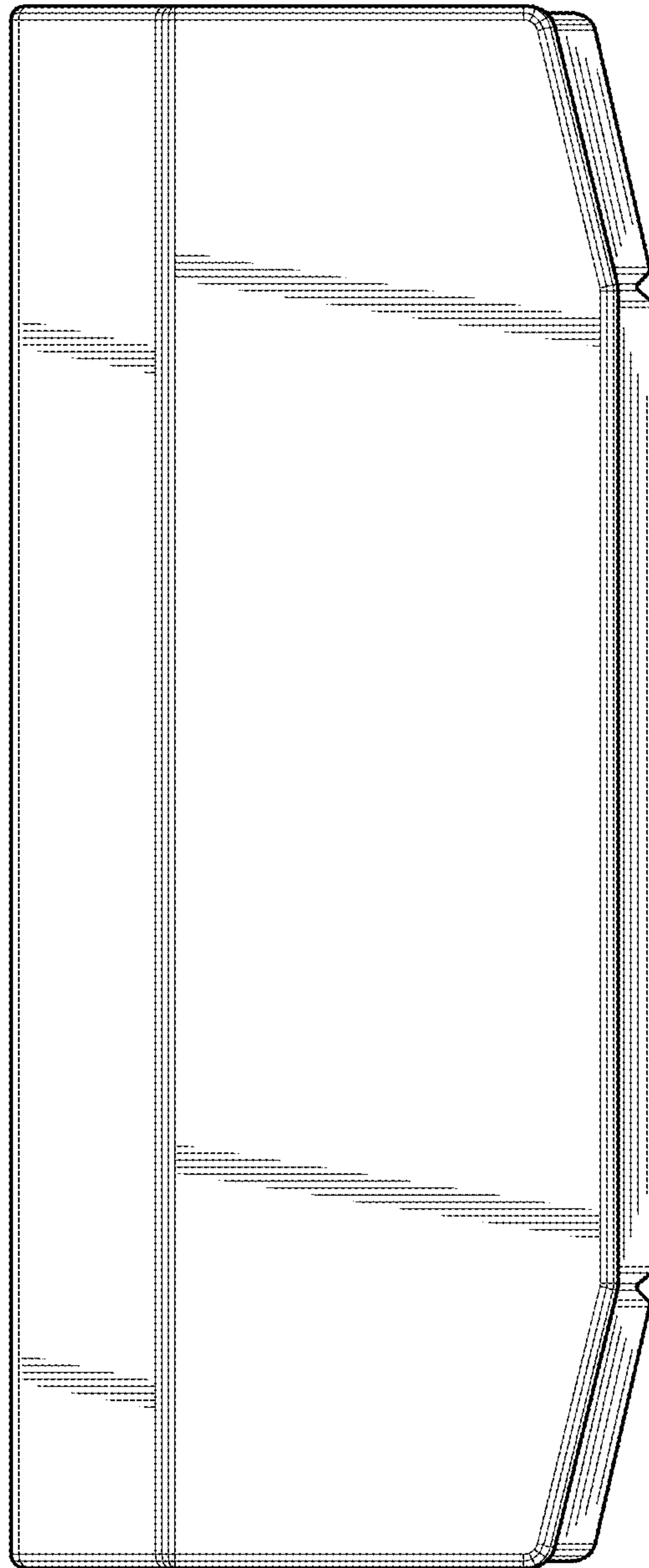

FIG. 5

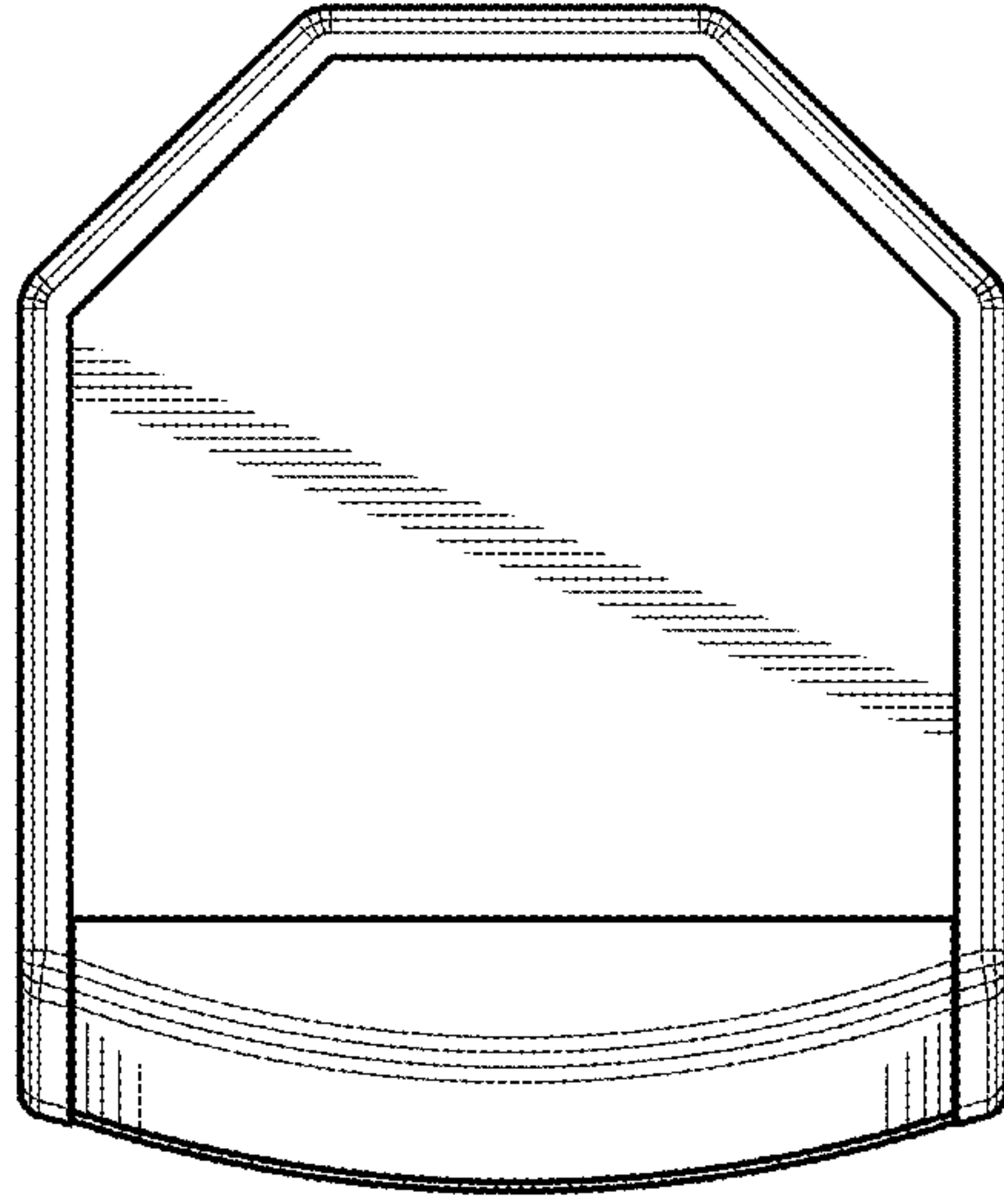

FIG. 7

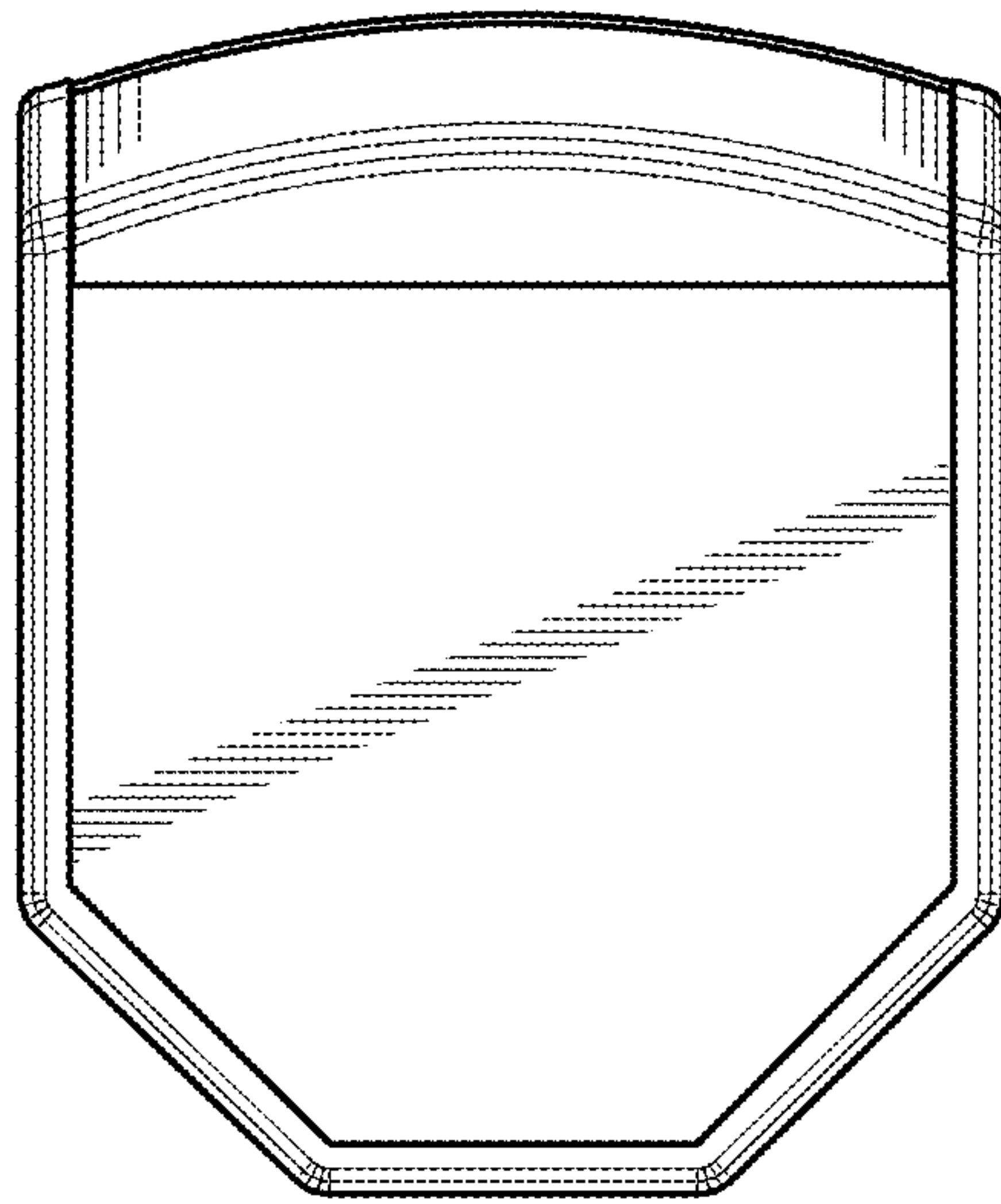

FIG. 6