



US00D784949S

(12) **United States Design Patent** (10) **Patent No.:** **US D784,949 S**
Kim (45) **Date of Patent:** **** Apr. 25, 2017**

(54) **MOBILE PHONE**

(71) Applicant: **LG ELECTRONICS INC., Seoul (KR)**

(72) Inventor: **Sungwoo Kim, Seoul (KR)**

(73) Assignee: **LG Electronics Inc., Seoul (KR)**

(**) Term: **15 Years**

(21) Appl. No.: **29/531,143**

(22) Filed: **Jun. 23, 2015**

(30) **Foreign Application Priority Data**

Dec. 24, 2014 (KR) 30-2014-0063166

(51) **LOC (10) Cl.** **14-03**

(52) **U.S. Cl.**
USPC **D14/138 G**

(58) **Field of Classification Search**
USPC D14/138 G, 138 AD, 341, 138 R, 496,
D14/203.1, 203.5, 203.7, 144, 250;
D21/517, 329

CPC .. G06F 1/1626; H04M 1/0266; H04M 1/0202
See application file for complete search history.

(56) **References Cited**

U.S. PATENT DOCUMENTS

| | | | | |
|--------------|--------|-------|-------|------------|
| D687,002 S * | 7/2013 | Song | | D14/138 G |
| D729,192 S * | 5/2015 | Chang | | D14/138 G |
| D730,861 S * | 6/2015 | Ryu | | D14/138 G |
| D732,500 S * | 6/2015 | Choe | | D14/138 G |
| D735,705 S * | 8/2015 | Lee | | D14/138 C |
| D736,171 S * | 8/2015 | Lee | | D14/138 G |
| D737,239 S * | 8/2015 | Lee | | D14/138 G |
| D756,950 S * | 5/2016 | Kim | | D14/138 G |
| D757,674 S * | 5/2016 | Seo | | D14/138 G |
| D758,335 S * | 6/2016 | Lee | | D14/138 G |
| D758,987 S * | 6/2016 | Kim | | D14/138 AA |

| | | | | |
|--------------|--------|-------|-------|------------|
| D761,749 S * | 7/2016 | Lee | | D14/138 AA |
| D762,606 S * | 8/2016 | Kim | | D14/138 G |
| D762,610 S * | 8/2016 | Joung | | D14/138 G |

(Continued)

OTHER PUBLICATIONS

LG G4c, posted at gsmarena.com, release date Jun. 2015, © 2000-2016 gsmarena.com, [online], [site visited Dec. 8, 2016]. Available from Internet, <URL: http://www.gsmarena.com/lg_g4c-pictures-7250.php>.*

(Continued)

Primary Examiner — Jeffrey D Asch

Assistant Examiner — Laura Yu

(74) *Attorney, Agent, or Firm* — Birch, Stewart, Kolasch & Birch, LLP

(57) **CLAIM**

The ornamental design for a mobile phone, as shown and described.

DESCRIPTION

FIG. 1 is a front perspective view of a mobile phone showing my new design;

FIG. 2 is a front view thereof;

FIG. 3 is a rear view thereof;

FIG. 4 is a left side view thereof;

FIG. 5 is a right side view thereof;

FIG. 6 is a top plan view thereof;

FIG. 7 is a bottom plan view thereof; and,

FIG. 8 is a rear perspective view thereof.

The broken lines that are immediately adjacent to the areas included in the claim, and define unshaded regions, represent the bounds of the claim. All other broken lines, including the broken lines within broken line boundaries, the display rectangle and the tiny circles, which occur beneath the front surface, and the circular camera features at the rear, show environment. The broken lines form no part of the claimed design.

1 Claim, 7 Drawing Sheets

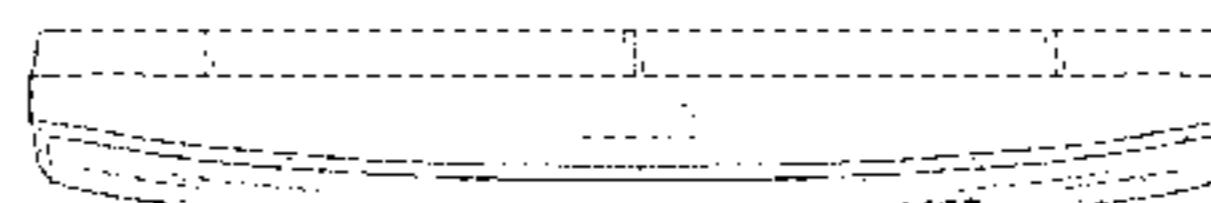
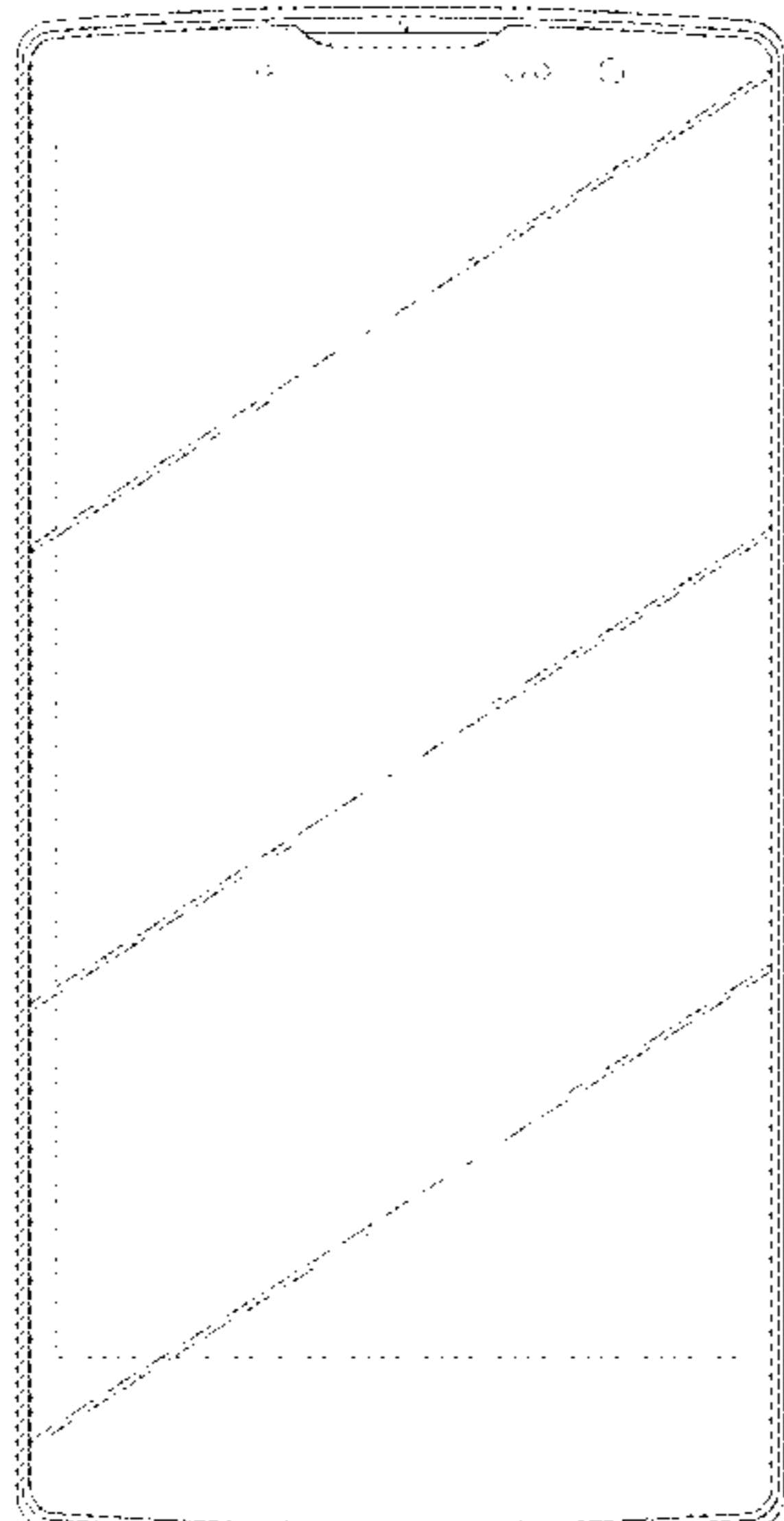

(56)

References Cited

U.S. PATENT DOCUMENTS

D763,218 S * 8/2016 Lim D14/138 G
D764,427 S * 8/2016 Park D14/138 G
D764,429 S * 8/2016 Choe D14/138 G
D765,067 S * 8/2016 Choe D14/248
D767,521 S * 9/2016 Joung D14/138 AD
D771,003 S * 11/2016 Kim D14/138 G

OTHER PUBLICATIONS

LG Spirit, posted at gsmarena.com, release date Mar. 2015, ©
2000-2016 gsmarena.com, [online], [site visited Dec. 8, 2016].
Available from Internet, <URL: http://www.gsmarena.com/lg_spirit-pictures-7052.php>.*

LG Magna, posted at gsmarena.com, release date May 2015, ©
2000-2016 gsmarena.com, [online], [site visited Dec. 8, 2016].
Available from Internet, <URL: http://www.gsmarena.com/lg_magna-pictures-7051.php>.*

LG G4 Dual posted at gsmarena.com, release date May 2015, ©
2000-2016 gsmarena.com, [online], [site visited Nov. 21, 2016].
Available from Internet, <URL: http://www.gsmarena.com/lg_g4_dual-pictures-7253.php>.*

* cited by examiner

FIG. 1

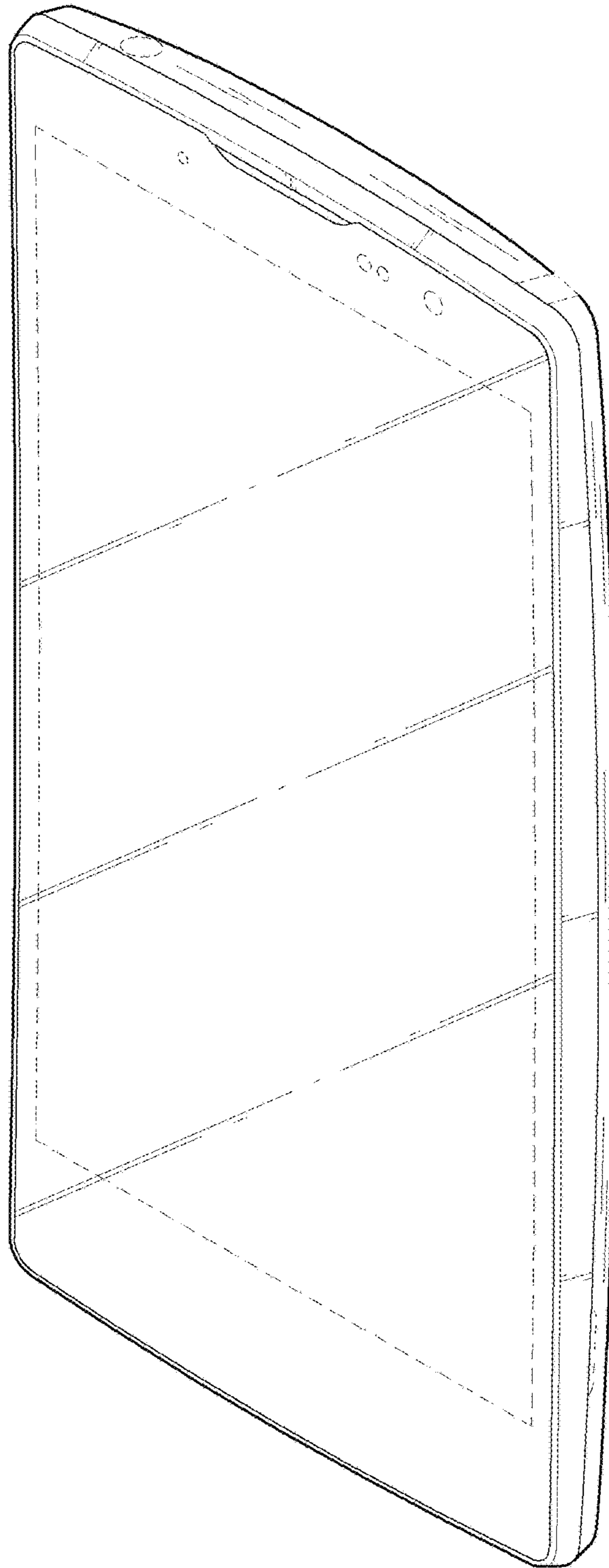

FIG. 2

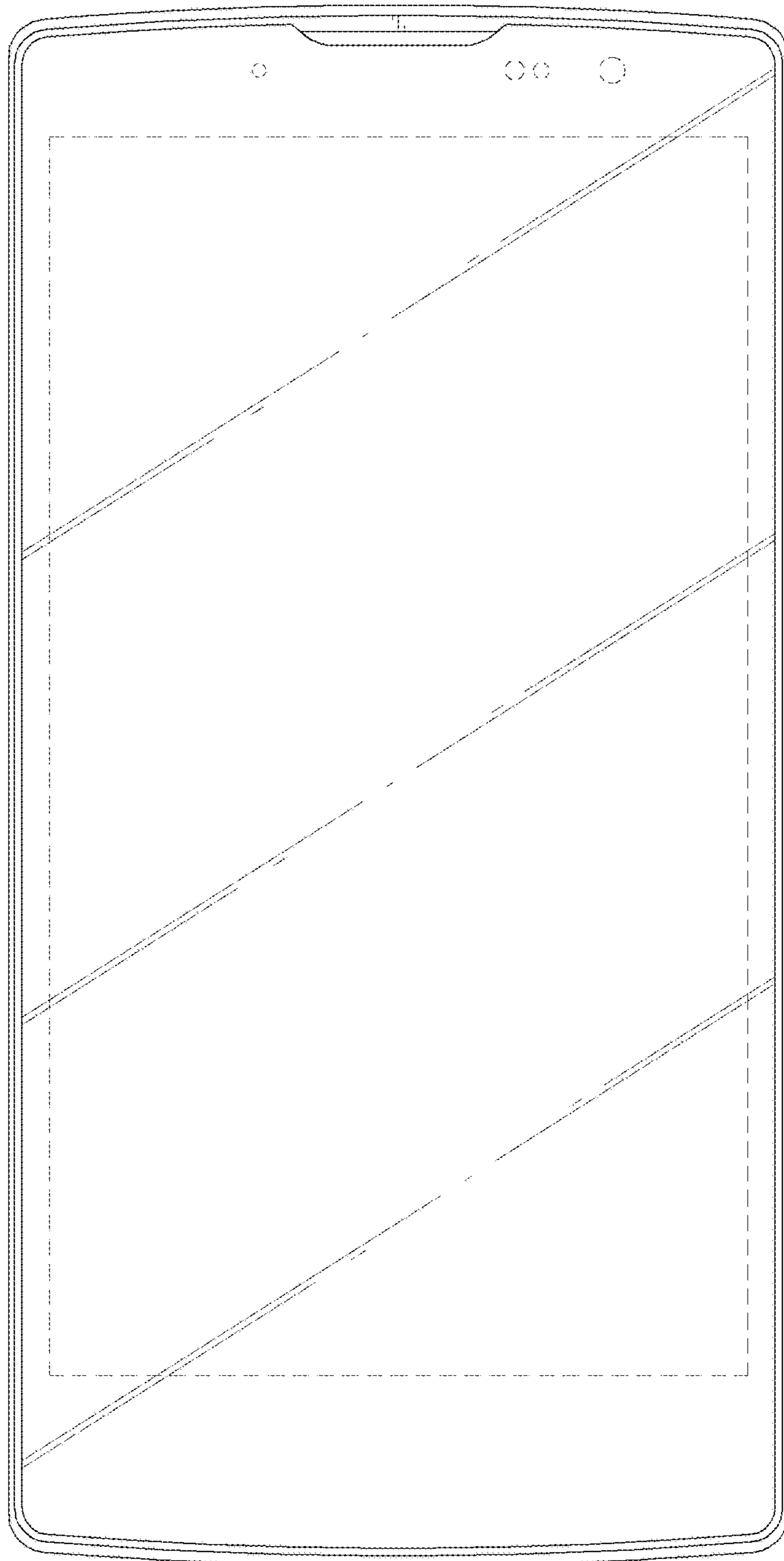

FIG. 3

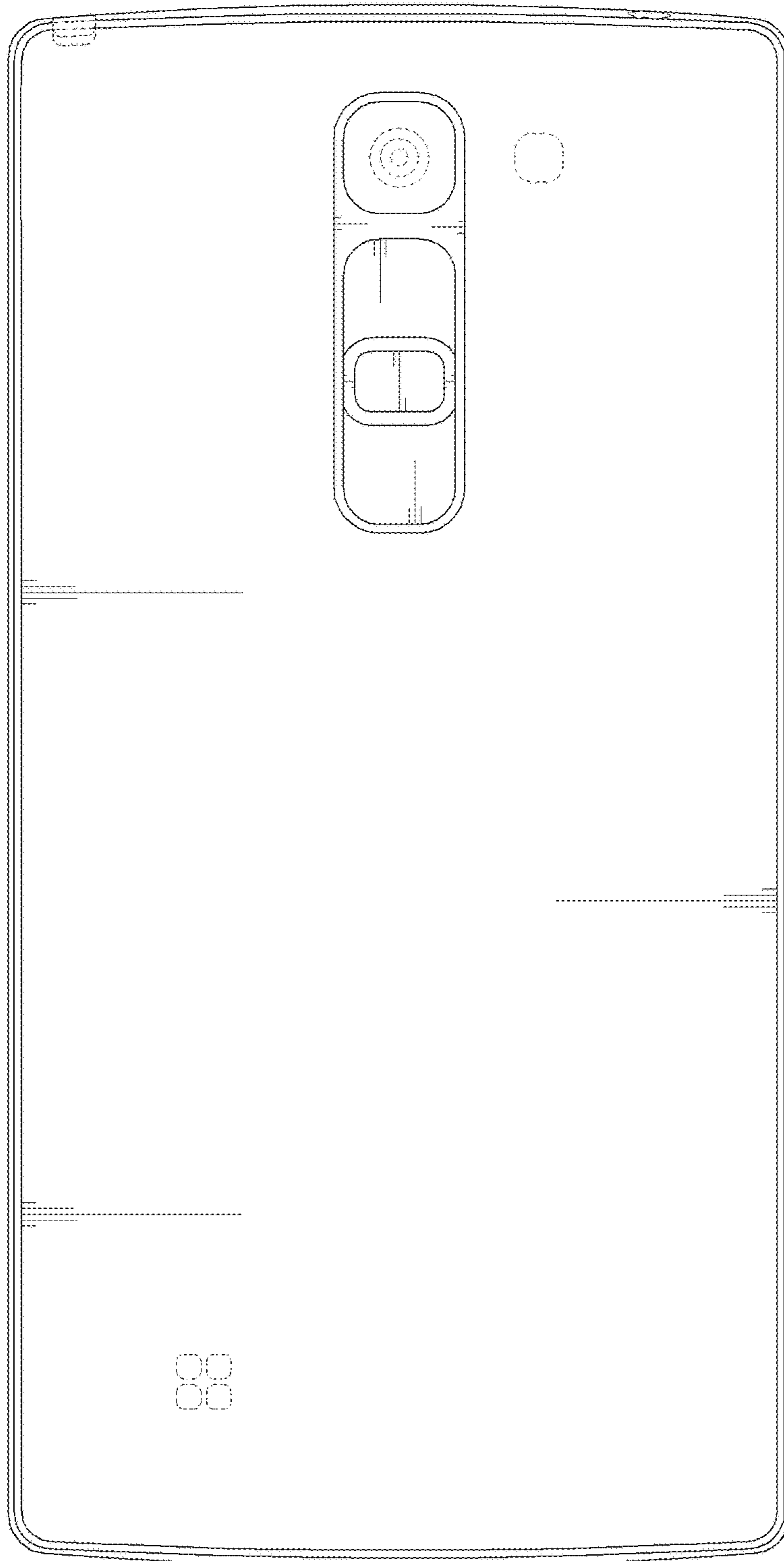

FIG. 4

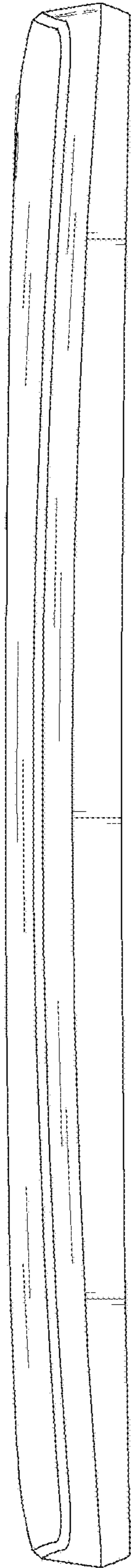

FIG. 5

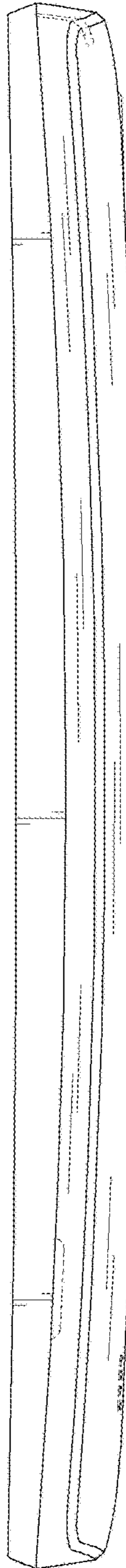

FIG. 6

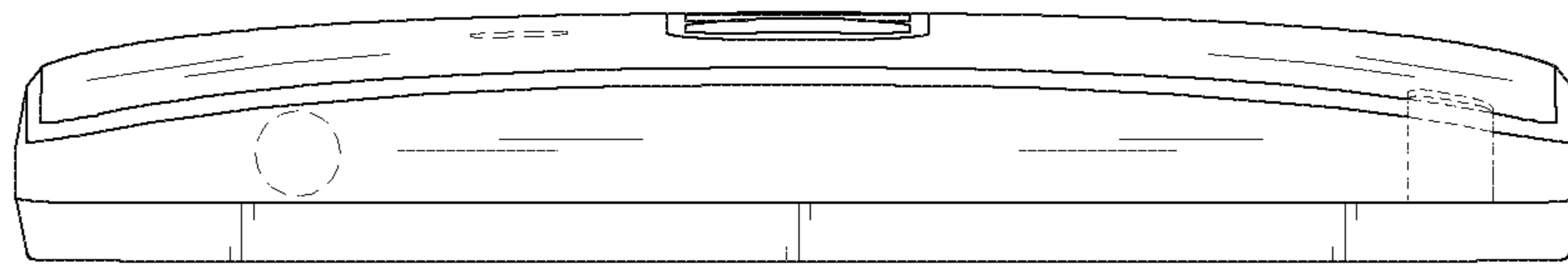

FIG. 7

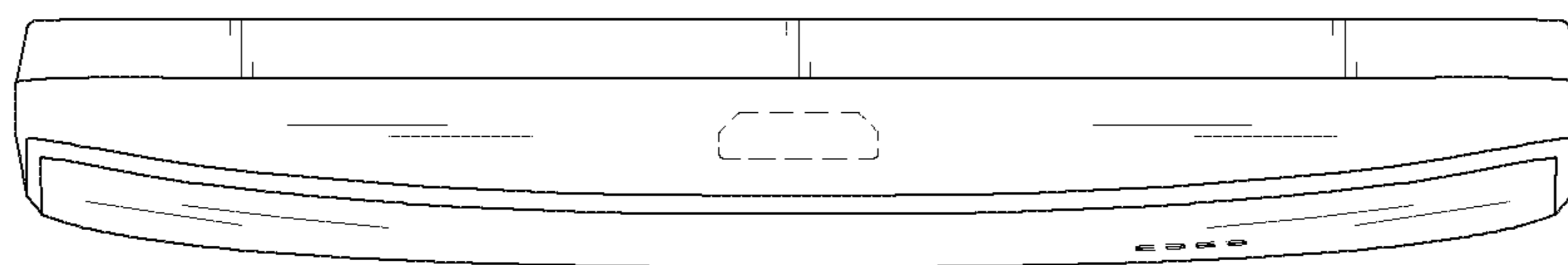

FIG. 8

