



US00D784843S

(12) **United States Design Patent**  
**Rafaelian**

(10) **Patent No.:** **US D784,843 S**

(45) **Date of Patent:** **\*\* Apr. 25, 2017**

(54) **BRACELET**

(71) Applicant: **Alex and Ani, LLC**, Cranston, RI (US)

(72) Inventor: **Carolyn A. Rafaelian**, Cranston, RI (US)

(73) Assignee: **Alex and Ani, LLC**, Cranston, RI (US)

(\*\*) Term: **15 Years**

(21) Appl. No.: **29/557,583**

(22) Filed: **Mar. 10, 2016**

(51) **LOC (10) Cl.** ..... **11-01**

(52) **U.S. Cl.**  
USPC ..... **D11/5**

(58) **Field of Classification Search**  
USPC ..... D11/1-39; D28/41  
CPC .. A44C 5/00; A44C 5/10; A44C 5/022; A44C 5/025; A44C 5/145; A44C 5/0007; A44C 5/0061; A44C 5/0076; A44C 5/0084; A44C 5/0092; A44C 5/2071; A44C 5/2085; A44C 9/0038; A44C 9/0053; A44C 17/02; A44C 5/0069; A44C 5/142  
See application file for complete search history.

(56) **References Cited**

**U.S. PATENT DOCUMENTS**

118,294 A	8/1871	Stevens
D14,438 S	11/1883	Ahn
393,239 A	11/1888	Johnstone
421,615 A	2/1890	Riker
933,303 A	5/1911	Kirby
1,124,518 A	1/1915	Qvarnstrom
D69,012 S	12/1925	Dalin
2,462,425 A	2/1949	Pratt et al.
D224,257 S	7/1972	Lee

(Continued)

**FOREIGN PATENT DOCUMENTS**

CA	154431	10/2014
CA	160435	3/2016

(Continued)

**OTHER PUBLICATIONS**

[No Author Listed] Sterling Silver Adjustable "Live Laugh Love" Graffiti Charm Bangle Bracelet. Webpage from Oct. 14, 2016. <https://amzn.com/B00M10MAH4>.

(Continued)

*Primary Examiner* — Garth Rademaker

*Assistant Examiner* — Richard Kearney

(74) *Attorney, Agent, or Firm* — Wolf, Greenfield & Sacks, P.C.

(57) **CLAIM**

The ornamental design for a bracelet, as shown and described.

**DESCRIPTION**

FIG. 1 is a top, front, left side, perspective view of a bracelet showing a first embodiment of our new design; FIG. 2 is a top, front, right side, perspective view thereof; FIG. 3 is a top plan view thereof; FIG. 4 is a front elevation view thereof; FIG. 5 is a rear elevation view thereof; FIG. 6 is a left side elevation view thereof; FIG. 7 is a right side elevation view thereof; FIG. 8 is a bottom plan view thereof; FIG. 9 is a top, front, left side, perspective view showing a second embodiment thereof; FIG. 10 is a top, front, right side, perspective view of FIG. 9; FIG. 11 is a top plan view of FIG. 9; FIG. 12 is a front elevation view of FIG. 9; FIG. 13 is a rear elevation view of FIG. 9; FIG. 14 is a left side elevation view of FIG. 9; FIG. 15 is a right side elevation view of FIG. 9; and, FIG. 16 is a bottom plan view of FIG. 9.

**1 Claim, 6 Drawing Sheets**

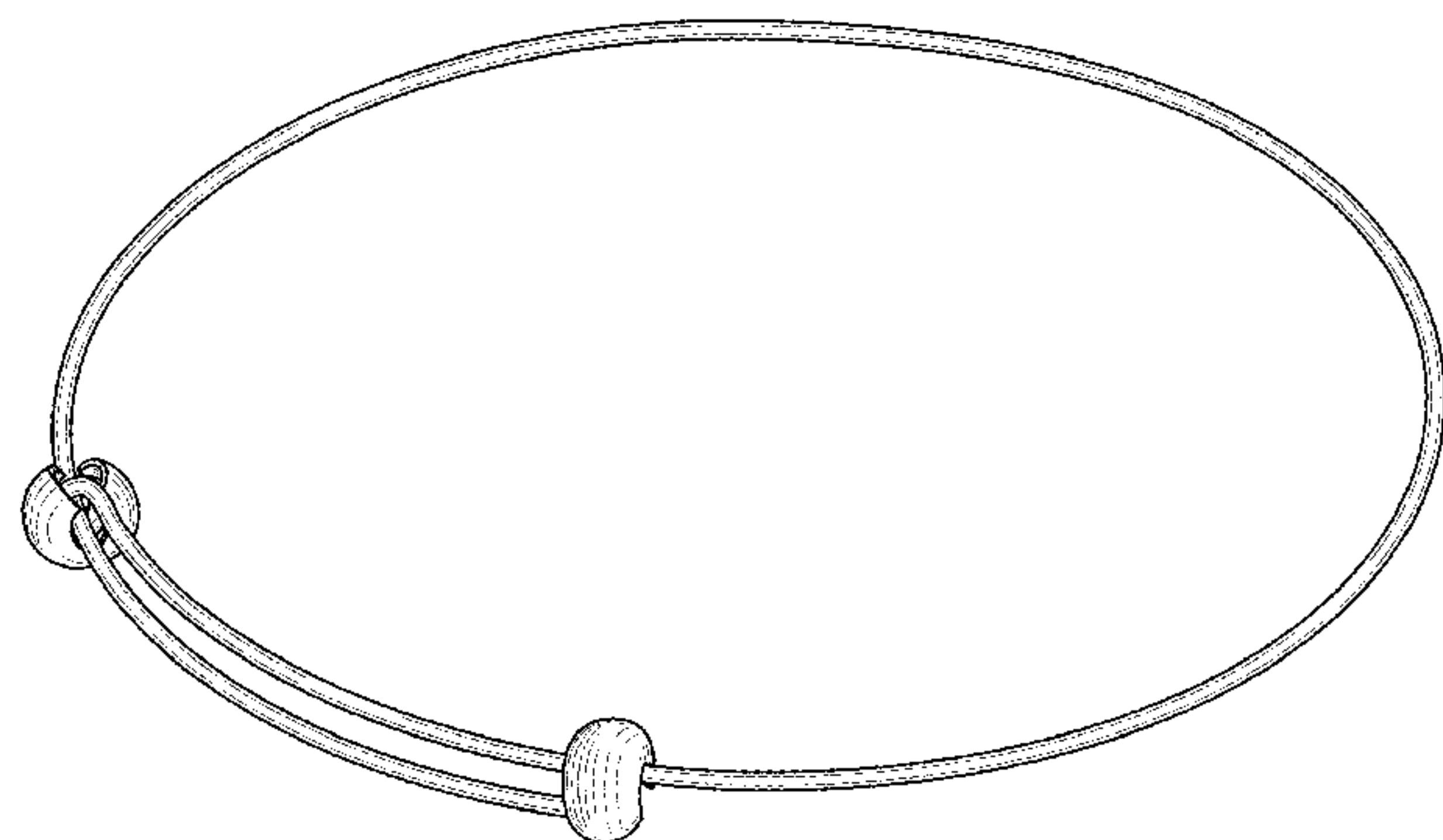
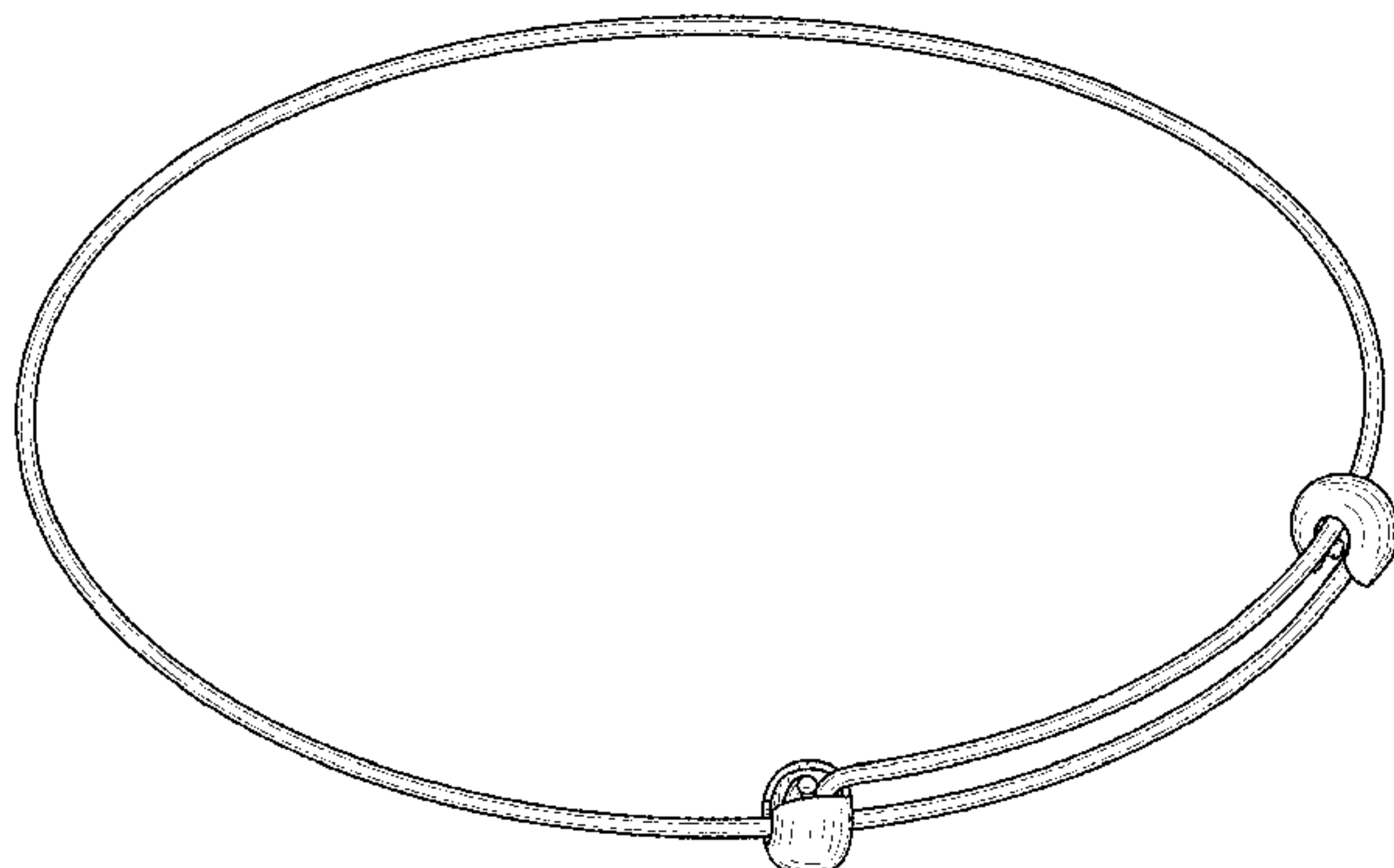

(56)

References Cited

U.S. PATENT DOCUMENTS

D245,834 S 9/1977 Wilbert  
 4,321,804 A 3/1982 Borofsky et al.  
 4,334,413 A 6/1982 Gaston et al.  
 D267,159 S 12/1982 Borofsky  
 D268,013 S 2/1983 Stimmler  
 D295,267 S 4/1988 Saraga  
 5,247,814 A 9/1993 McDonald  
 5,307,582 A 5/1994 Quintel  
 D382,829 S 8/1997 Hoffman  
 D439,192 S 3/2001 Ruscitti  
 D472,177 S 3/2003 McCullough-McPherson  
 6,564,582 B1 5/2003 Brachfeld  
 D487,709 S 3/2004 Ferlise  
 D498,167 S 11/2004 Ferlise  
 D525,553 S 7/2006 Toupet  
 D619,026 S 7/2010 Papadimitriou  
 D658,085 S 4/2012 Rafaelian  
 D658,086 S 4/2012 Rafaelian  
 D658,087 S 4/2012 Rafaelian  
 D658,088 S 4/2012 Rafaelian  
 D658,089 S 4/2012 Rafaelian  
 D658,528 S 5/2012 Rafaelian  
 D662,849 S 7/2012 Rafaelian  
 D663,232 S 7/2012 Rafaelian  
 D663,233 S 7/2012 Rafaelian  
 D664,466 S 7/2012 Rafaelian  
 D669,115 S \* 10/2012 Kalbach ..... D16/339  
 D669,385 S 10/2012 Rafaelian  
 D672,678 S \* 12/2012 Nadeau ..... D11/11  
 D678,102 S 3/2013 Rafaelian  
 D686,520 S 7/2013 Rafaelian  
 D700,860 S 3/2014 Nadeau  
 D703,087 S 4/2014 Fiasconaro  
 D703,088 S 4/2014 Fiasconaro  
 D704,085 S 5/2014 DiPietro  
 D704,086 S \* 5/2014 DiPietro ..... D11/5  
 D704,087 S \* 5/2014 DiPietro ..... D11/5  
 D706,665 S 6/2014 Goldwitz  
 D707,149 S 6/2014 Ovadia  
 D707,582 S \* 6/2014 DiPietro ..... D11/5  
 D708,088 S 7/2014 DeCristofaro  
 D709,789 S \* 7/2014 Soares ..... D11/5  
 8,769,986 B1 \* 7/2014 DiPietro ..... A44C 5/0092  
 63/3.1  
 RE45,079 E 8/2014 Ferlise  
 D710,738 S \* 8/2014 Kim ..... D11/4  
 D716,175 S 10/2014 Rosenel  
 D724,470 S 3/2015 Rafaelian  
 D724,471 S 3/2015 Blondet  
 D724,472 S 3/2015 Blondet  
 D724,473 S 3/2015 Blondet  
 D724,474 S 3/2015 Blondet  
 D724,475 S 3/2015 Lux

D724,985 S 3/2015 Blondet  
 D724,986 S 3/2015 Blondet  
 D729,101 S 5/2015 Rafaelian  
 D738,773 S 9/2015 Rafaelian  
 9,301,580 B1 4/2016 Rafaelian  
 2007/0022778 A1 2/2007 Ferlise  
 2014/0090215 A1 4/2014 Lixenberg

FOREIGN PATENT DOCUMENTS

EP 1 038 463 A1 9/2000  
 GB 233872 A 5/1925  
 JP 1177437 S 6/2003  
 JP 1268404 S 4/2006  
 JP 1496501 S 5/2014  
 KR 3008138520000 9/2005

OTHER PUBLICATIONS

U.S. Appl. No. 29/509,562, filed Nov. 19, 2014, Rafaelian.  
 U.S. Appl. No. 29/521,776, filed Mar. 26, 2015, Rafaelian.  
 U.S. Appl. No. 29/557,585, filed Mar. 10, 2016, Rafaelian.  
 U.S. Appl. No. 29/557,586, filed Mar. 10, 2016, Rafaelian.  
 U.S. Appl. No. 29/557,589, filed Mar. 10, 2016, Rafaelian.  
 U.S. Appl. No. 29/557,591, filed Mar. 10, 2016, Rafaelian.  
 Hinks, Victorian Jewellery. pp. 41, 97, 200, 201, 204. 1991. 6 pages.  
 [No Author Listed] Illustrated Jewelry Catalog 1892. The New England Jeweler. 1998; p. 52.  
 [No Author Listed] How to make a sliding adjustable necklace. Rings & Things Jewelry Making Blog. Jun. 2011. <http://www.rings-things.com/blog/2011/06/23/how-to-make-a-sliding-adjustable-necklace/> [accessed Dec. 12, 2014]. 3 pages.  
 [No Author Listed] Rings & Things Blog. Jun. 23, 2011. <http://www.rings-things.com/blog/2011/06/#.VDRi6fldUWY>. 1 page.  
 [No Author Listed] Sterling Silver Black Leather Expandable Cord Bracelet #312709—IceCarats. <http://www.icecarats.com/sterling-silver-black-leather-expandable-cord-bracelet-312709...> [accessed Dec. 12, 2014]. 4 pages.  
 [No Author Listed] Sterling Silver Claddagh Baby Childrens Bracelet Expandable 6.5 in. BlingJewelry.com [http://www.blingjewelry.com/bling-jewelry-sterling-silver-claddagh-baby-childrens-bangle-bracelet-expandable.html?gclid=CjwKEAjwms6hBRDTpb\\_jkbTv1UYSJACBhberDYKsTmUeeL1zKQhqmXJpCt5R0FaU-0vmR0fDtylGSrBoCwDPw\\_wcB](http://www.blingjewelry.com/bling-jewelry-sterling-silver-claddagh-baby-childrens-bangle-bracelet-expandable.html?gclid=CjwKEAjwms6hBRDTpb_jkbTv1UYSJACBhberDYKsTmUeeL1zKQhqmXJpCt5R0FaU-0vmR0fDtylGSrBoCwDPw_wcB) [Accessed Aug. 5, 2016]. 3 pages.  
 [No Author Listed] Sterling Silver Claddagh Baby Childrens Bracelet Expandable 6.5 in. [http://www.blingjewelry.com/bling-jewelry-sterling-silver-claddagh-baby-childrens-bangle-bracelet-expandable.html?gclid=CjwKEAjwms6hBRDTpb\\_jkbTv1UYSJACBhberDYKsTmUeeL1zKQhqmXJpCt5R0FaU-0vmR0fDtylGSrBoCwDPw\\_wcB](http://www.blingjewelry.com/bling-jewelry-sterling-silver-claddagh-baby-childrens-bangle-bracelet-expandable.html?gclid=CjwKEAjwms6hBRDTpb_jkbTv1UYSJACBhberDYKsTmUeeL1zKQhqmXJpCt5R0FaU-0vmR0fDtylGSrBoCwDPw_wcB) [Accessed at least as early as Aug. 10, 2015]. 1 page.

\* cited by examiner



FIG. 1

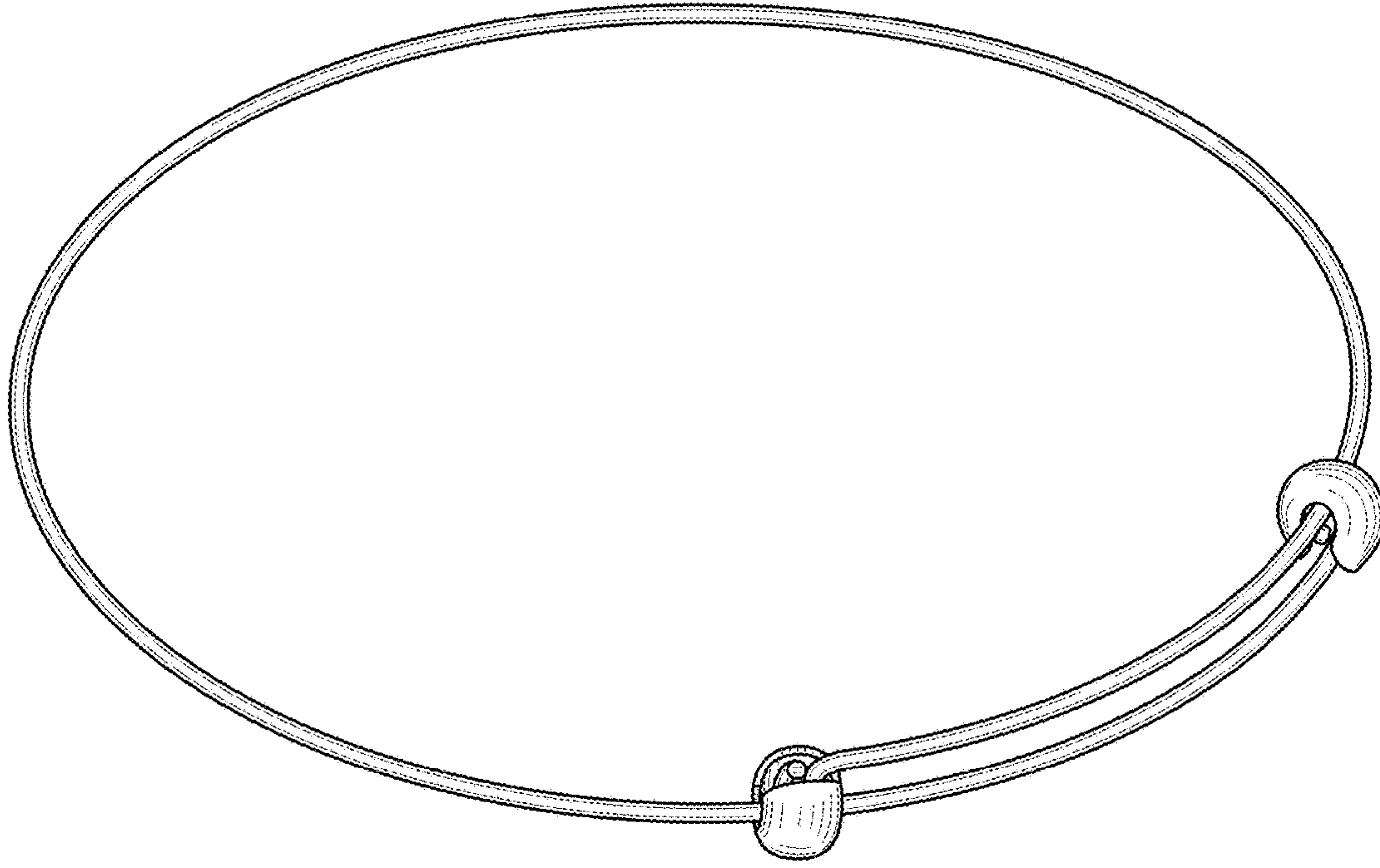

FIG. 2

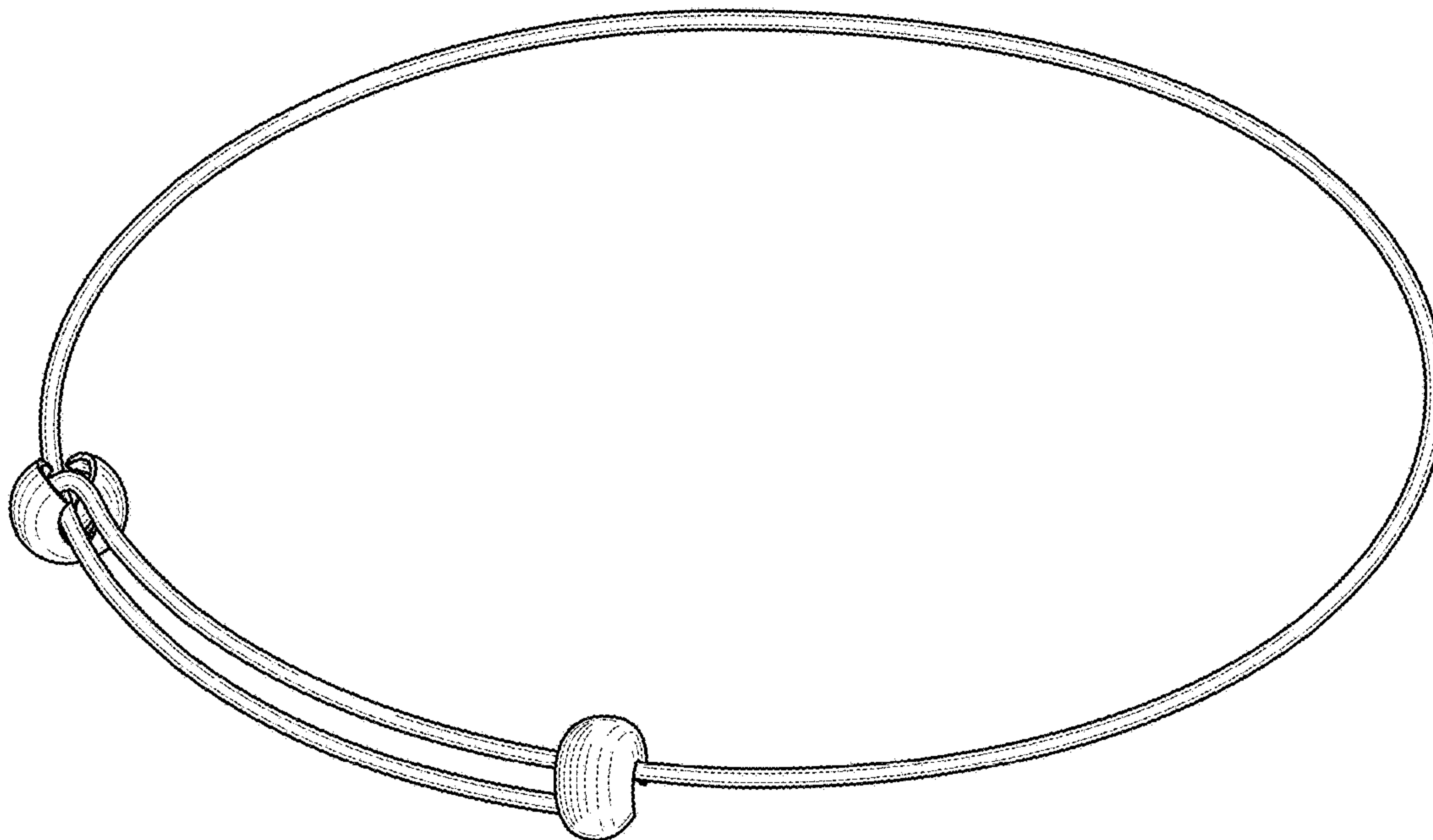

FIG. 3

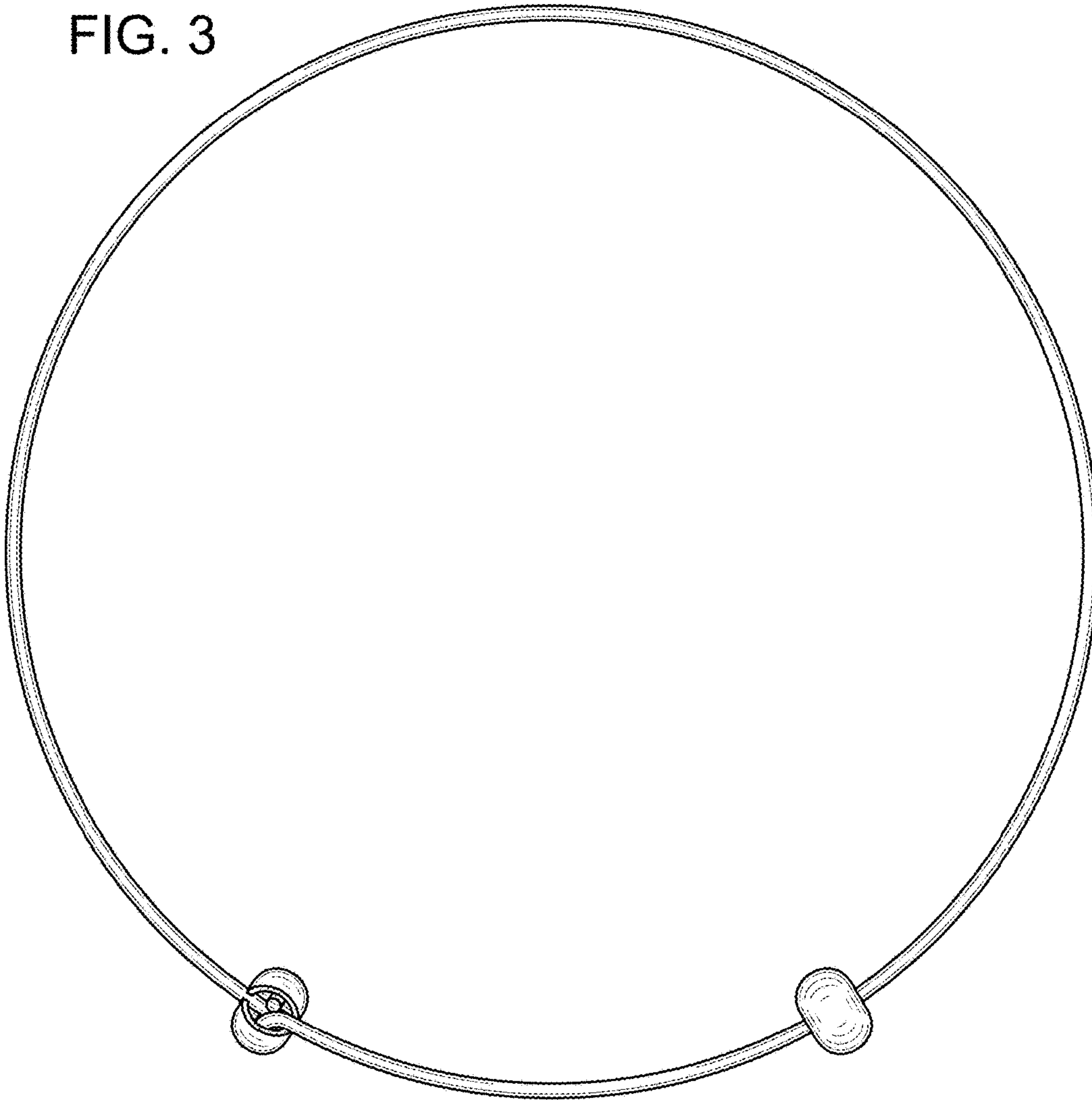

FIG. 4

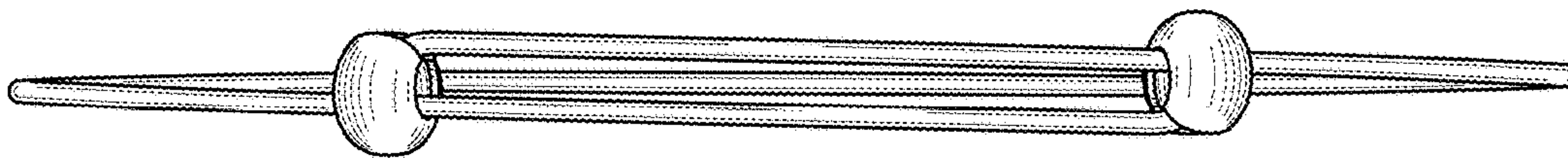

FIG. 5

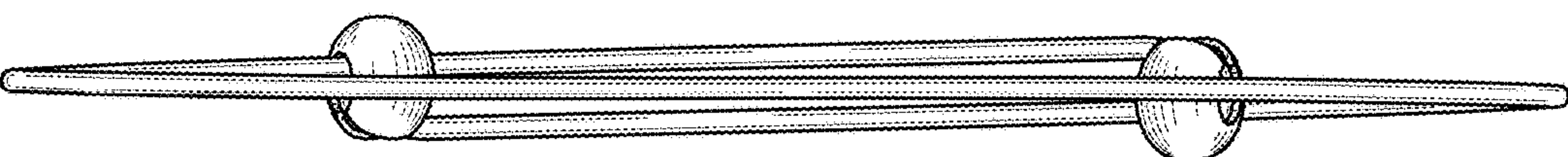

FIG. 6

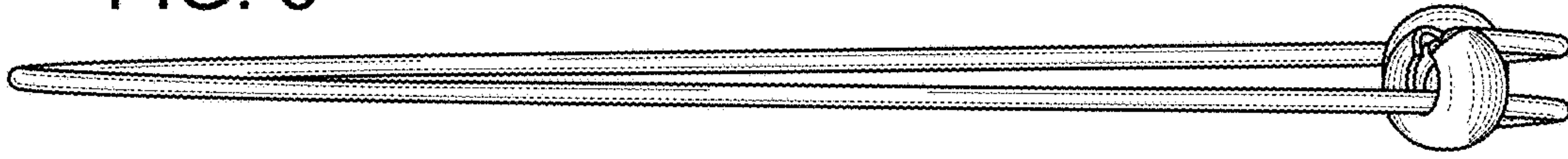

FIG. 7

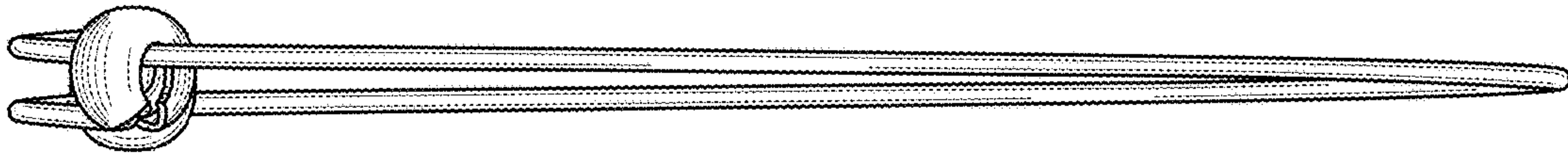

FIG. 8

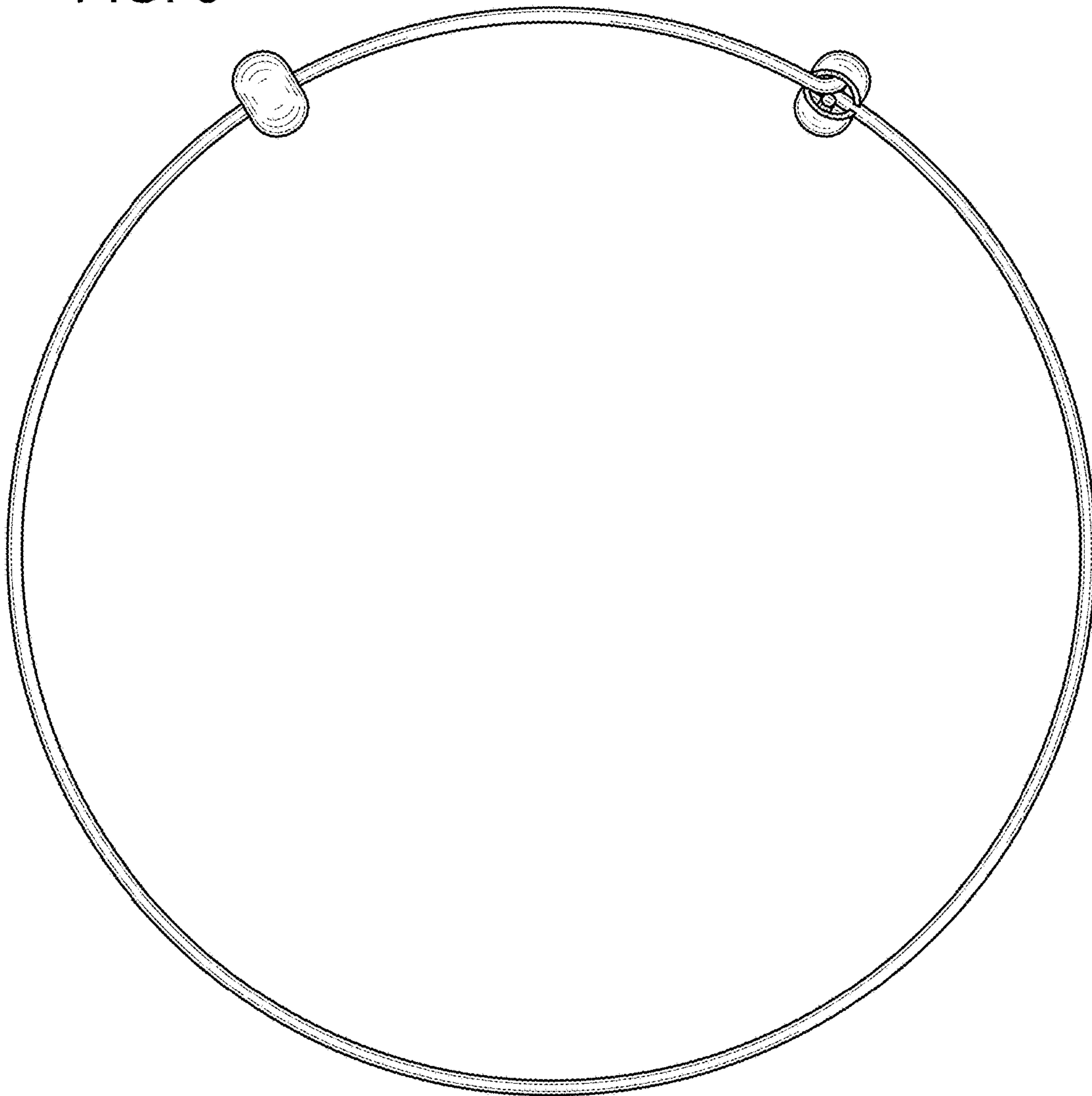

FIG. 9

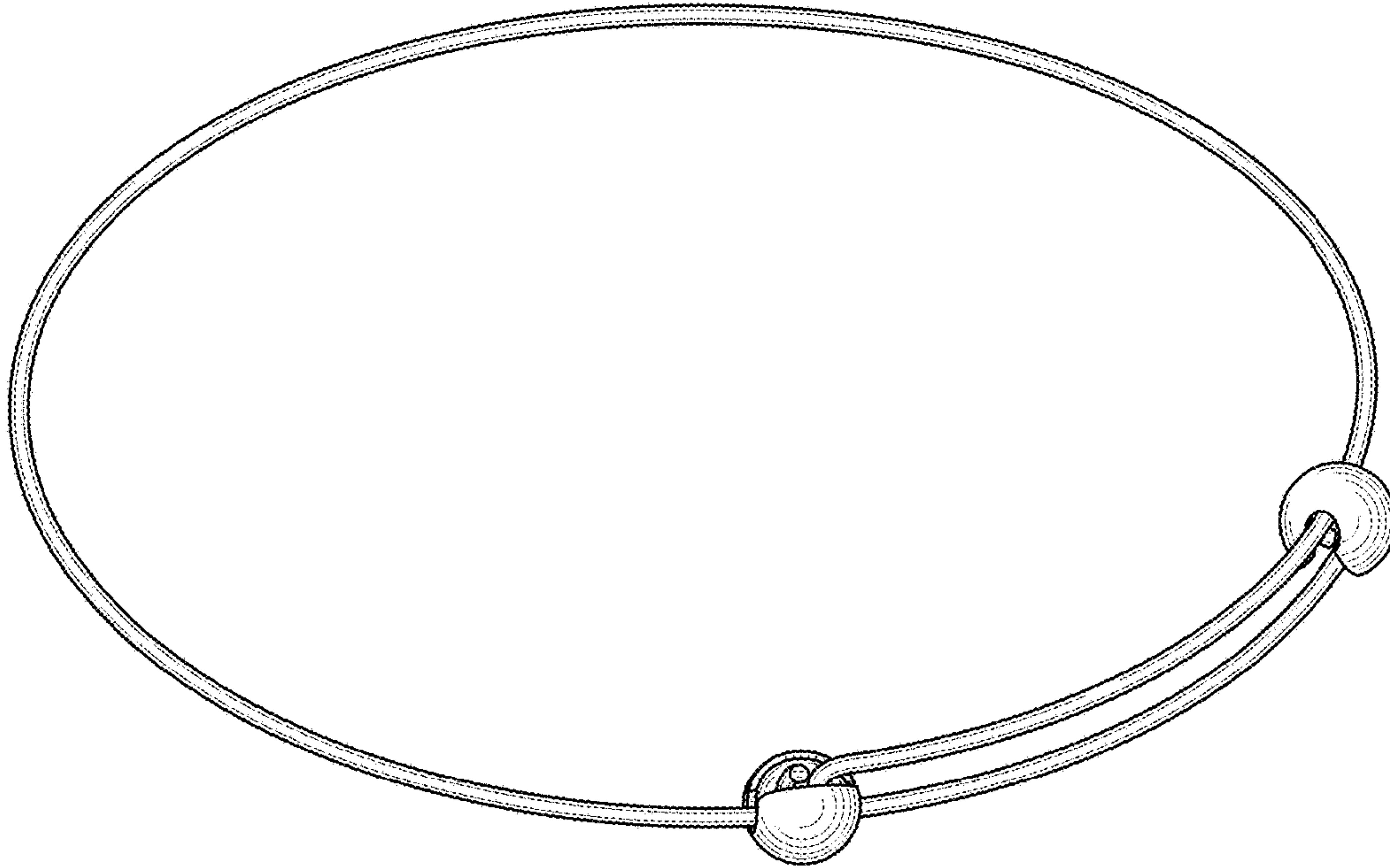

FIG. 10

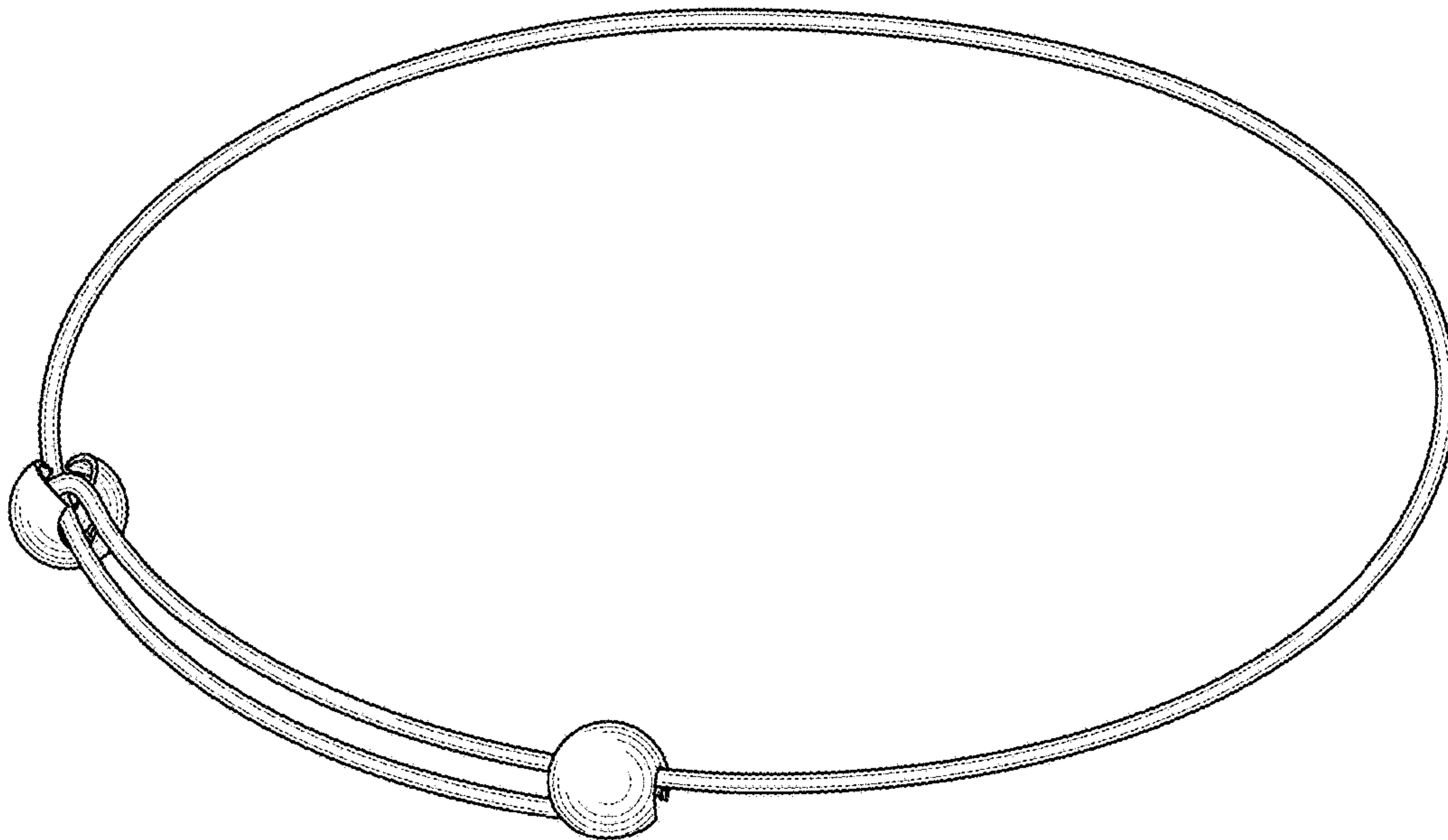



FIG. 11

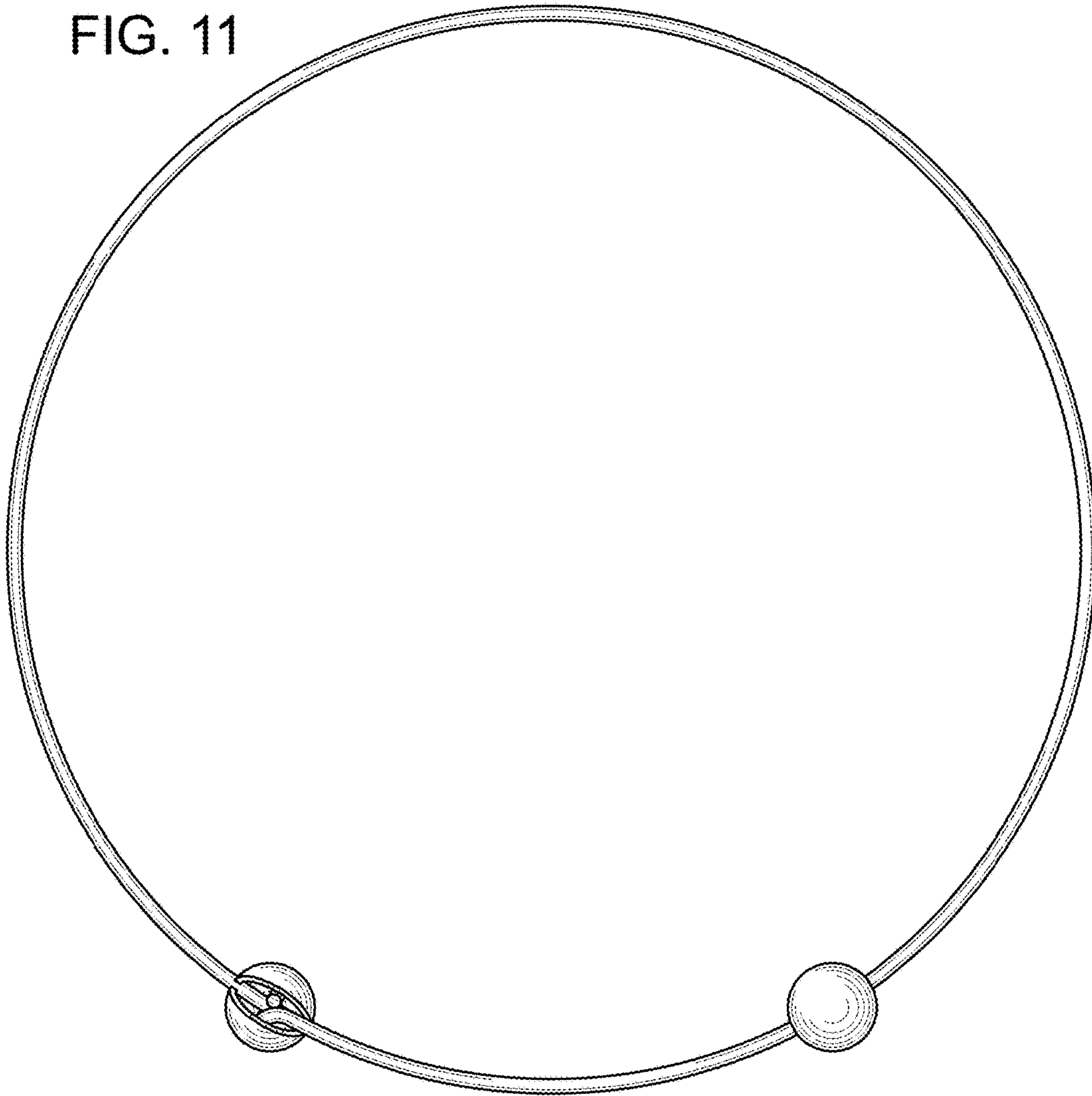

FIG. 12

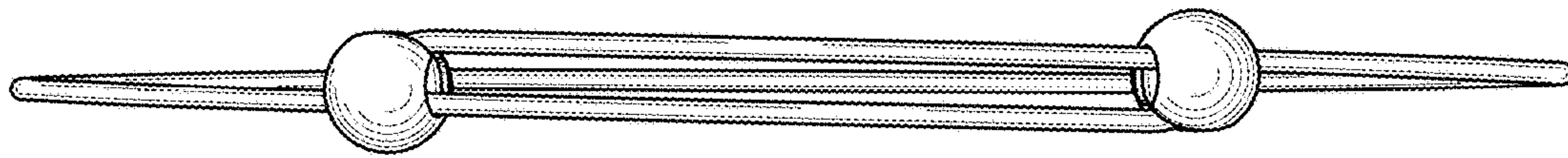

FIG. 13

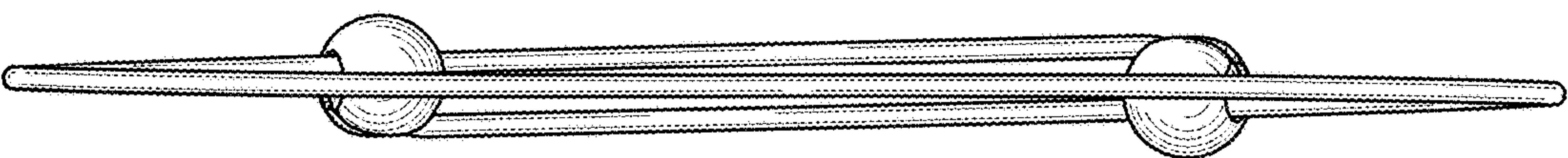

FIG. 14

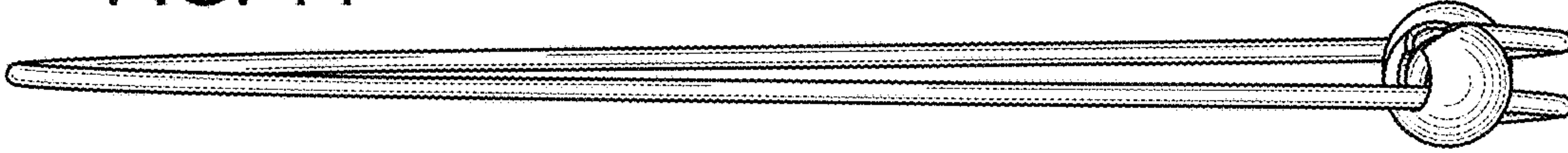

FIG. 15

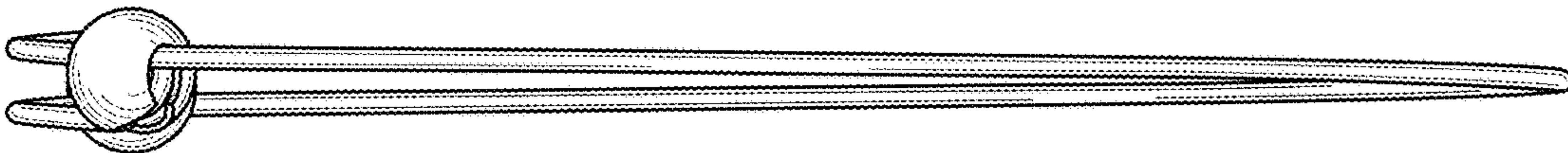

FIG. 16

