



US00D784840S

(12) **United States Design Patent**
Caballero

(10) **Patent No.:** **US D784,840 S**

(45) **Date of Patent:** **** Apr. 25, 2017**

- (54) **ARMBAND BRACELET**
- (71) Applicant: **Raul Caballero**, City of Mexico (MX)
- (72) Inventor: **Raul Caballero**, City of Mexico (MX)
- (**) Term: **15 Years**
- (21) Appl. No.: **29/562,676**
- (22) Filed: **Apr. 28, 2016**
- (51) **LOC (10) Cl.** **11-01**
- (52) **U.S. Cl.**
USPC **D11/4**
- (58) **Field of Classification Search**
USPC D11/1-39; D28/39, 41-43
CPC .. A44C 5/00; A44C 5/10; A44C 5/022; A44C
5/025; A44C 5/142; A44C 5/145; A44C
5/0007; A44C 5/0061; A44C 5/0069;
A44C 5/0076; A44C 5/0084; A44C
5/0092; A44C 5/2071; A44C 5/2085;
A44C 9/0007; A44C 9/0015; A44C
9/0038; A44C 9/0046; A44C 9/0053;
A44C 9/0084; A44C 9/001; A44C 9/02;
A44C 17/02; A44C 17/001; A44C
17/003; A44C 17/005
See application file for complete search history.

D723,965 S * 3/2015 Le Bail D11/27
 9,442,578 B2 * 9/2016 Oh G06F 3/03545
 2012/0214380 A1 * 8/2012 Vine, III A44C 5/0084
 446/121

OTHER PUBLICATIONS

Jibanyan Watch Hanger (available online) Retrieved from the internet Dec. 7, 2016, retrieved from the internet URL: www.justtoysint.com/product/jibanyan/.*

Play Nintendo reference (available online Oct. 10, 2015) Retrieved from the internet Dec. 7, 2016, retrieved from the internet URL: http://play.nintendo.com/themes/friends/jibanyan.*

* cited by examiner

Primary Examiner — Garth Rademaker

Assistant Examiner — Richard Kearney

(74) *Attorney, Agent, or Firm* — Noli IP Solutions, PC; Raouf Rizk

(57) **CLAIM**

What is claimed is the ornamental design for an armband bracelet, as shown and described.

DESCRIPTION

FIG. 1 is a front, left side perspective view of an armband bracelet according to my new design.

FIG. 2 is a right side elevation view of the armband bracelet of FIG. 1.

FIG. 3 is a front elevation view of the armband bracelet of FIG. 1.

FIG. 4 is a rear elevation view of the armband bracelet of FIG. 1.

FIG. 5 is a left side elevation view of the armband bracelet of FIG. 1.

FIG. 6 is a bottom plan view of the armband bracelet of FIG. 1; and,

FIG. 7 is a top plan view of the armband bracelet of FIG. 1.

1 Claim, 5 Drawing Sheets

(56) **References Cited**

U.S. PATENT DOCUMENTS

- D39,444 S * 8/1908 Leiser D11/26
- D87,916 S * 10/1932 Granat D11/26
- D239,312 S * 3/1976 Foreman D11/27
- D301,559 S * 6/1989 Wood D1/109
- D427,106 S * 6/2000 Ben-Shimon D11/27
- D430,814 S * 9/2000 Lauper D11/26
- D612,282 S * 3/2010 Iacomucci D11/4
- D640,949 S * 7/2011 Iacomucci D11/31
- D691,506 S * 10/2013 Hardy D11/27
- D718,174 S * 11/2014 Le Bail D11/27

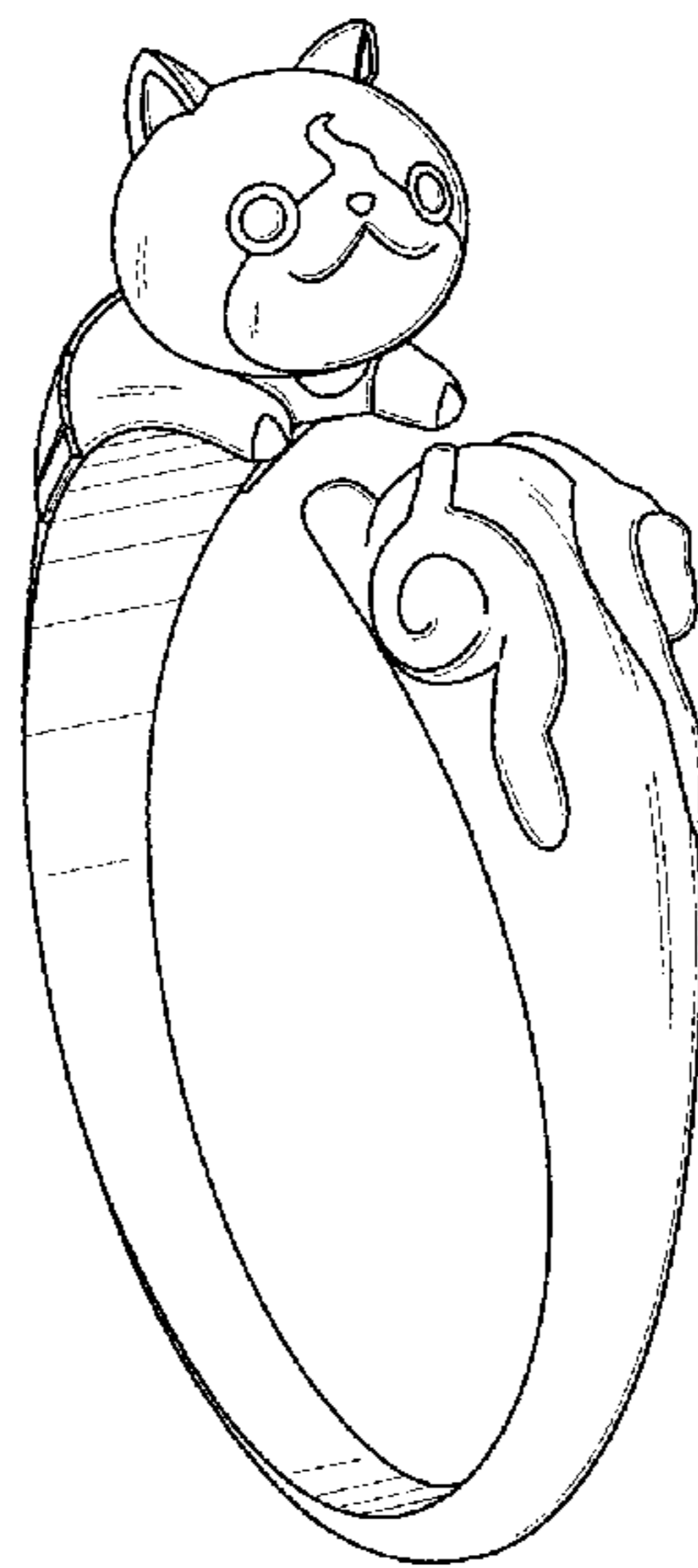

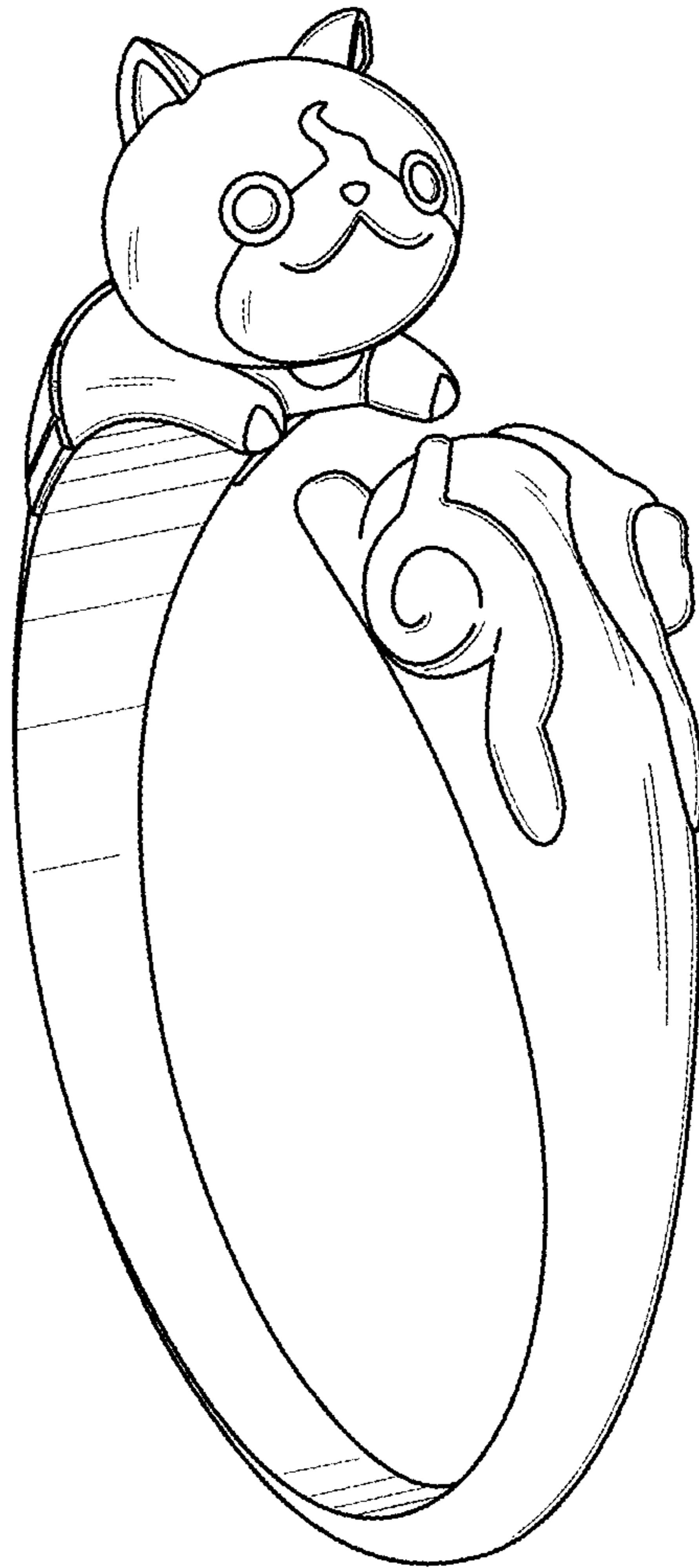

FIG. 1

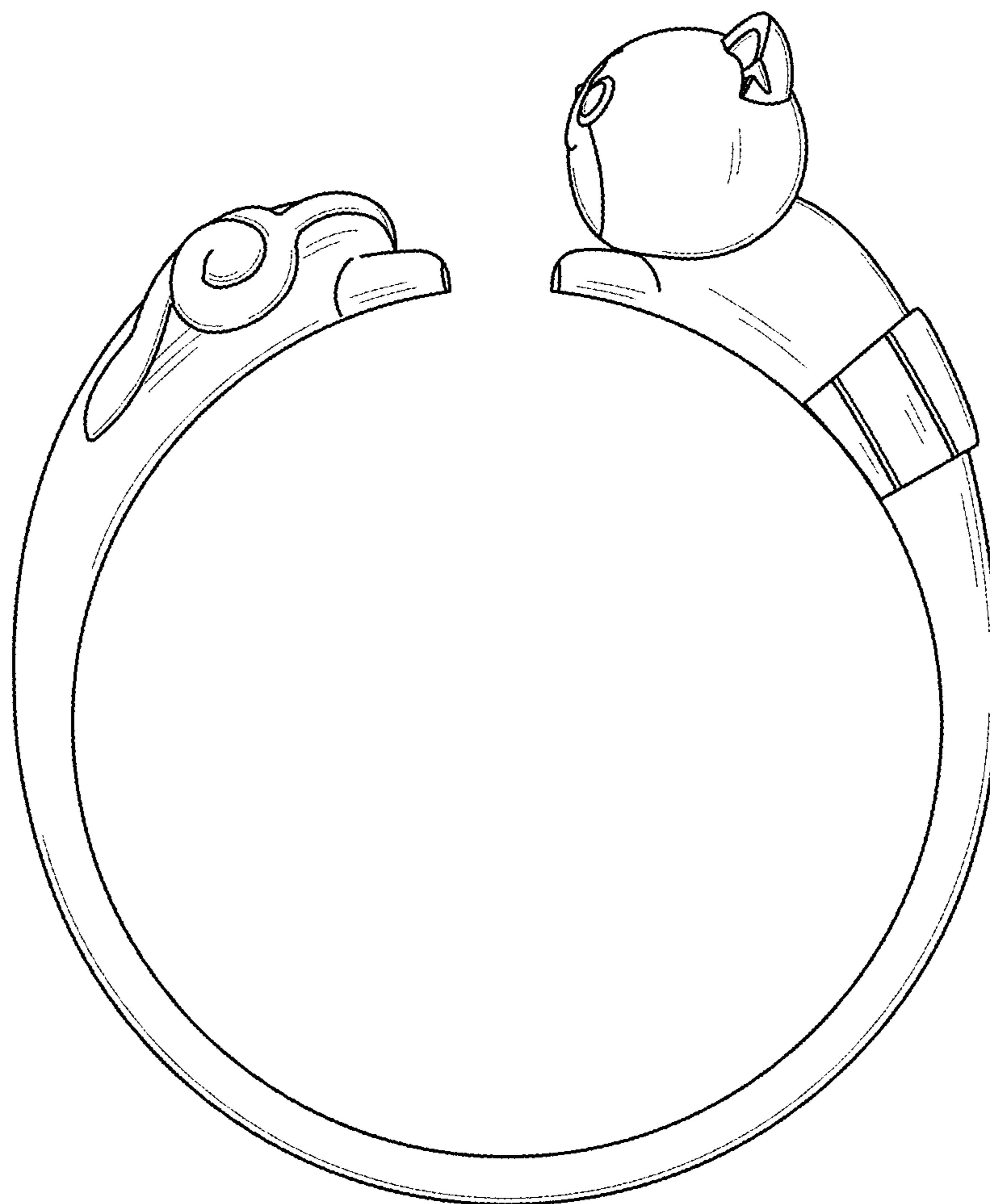

FIG. 2

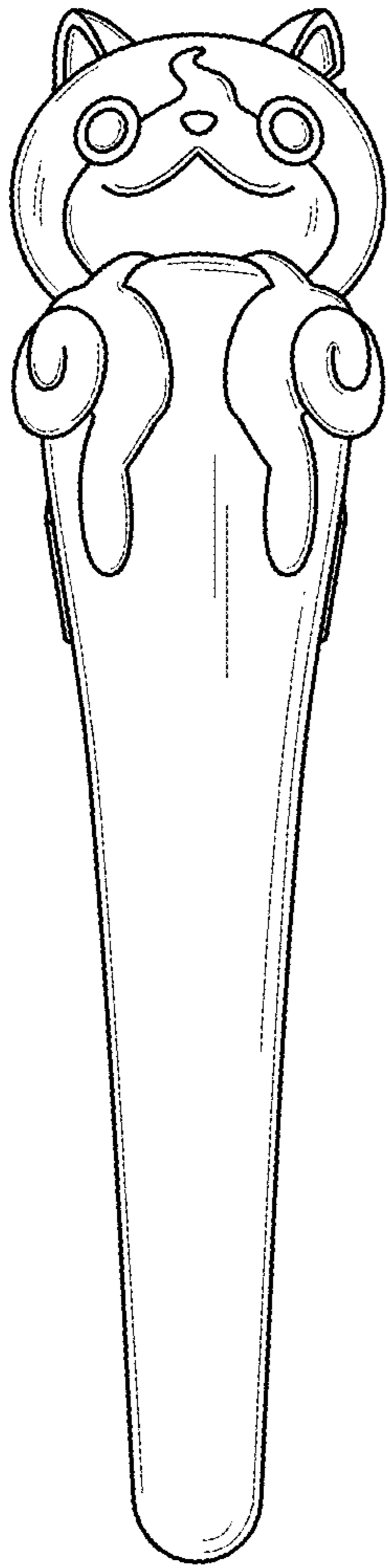

FIG. 3

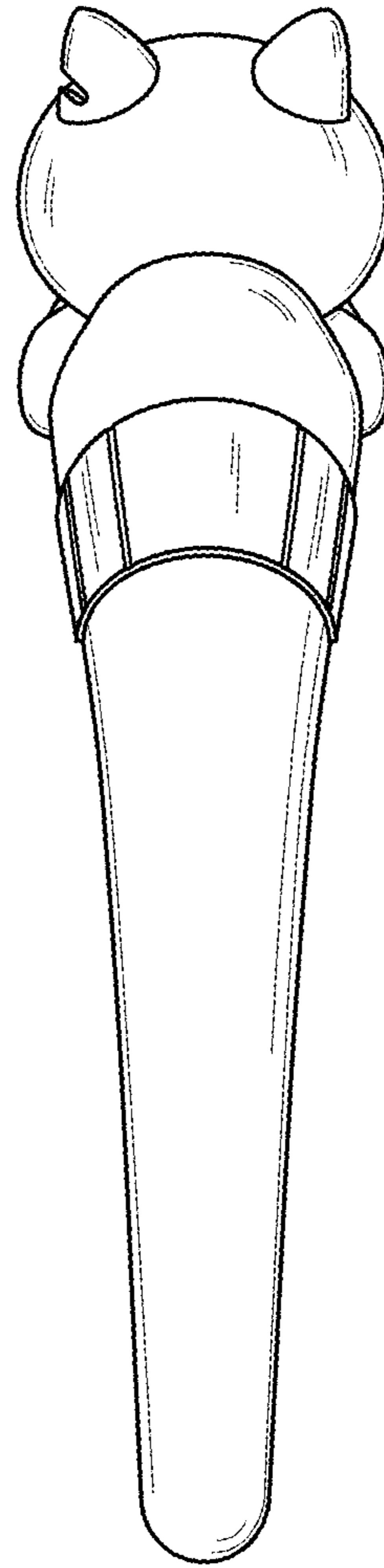

FIG. 4

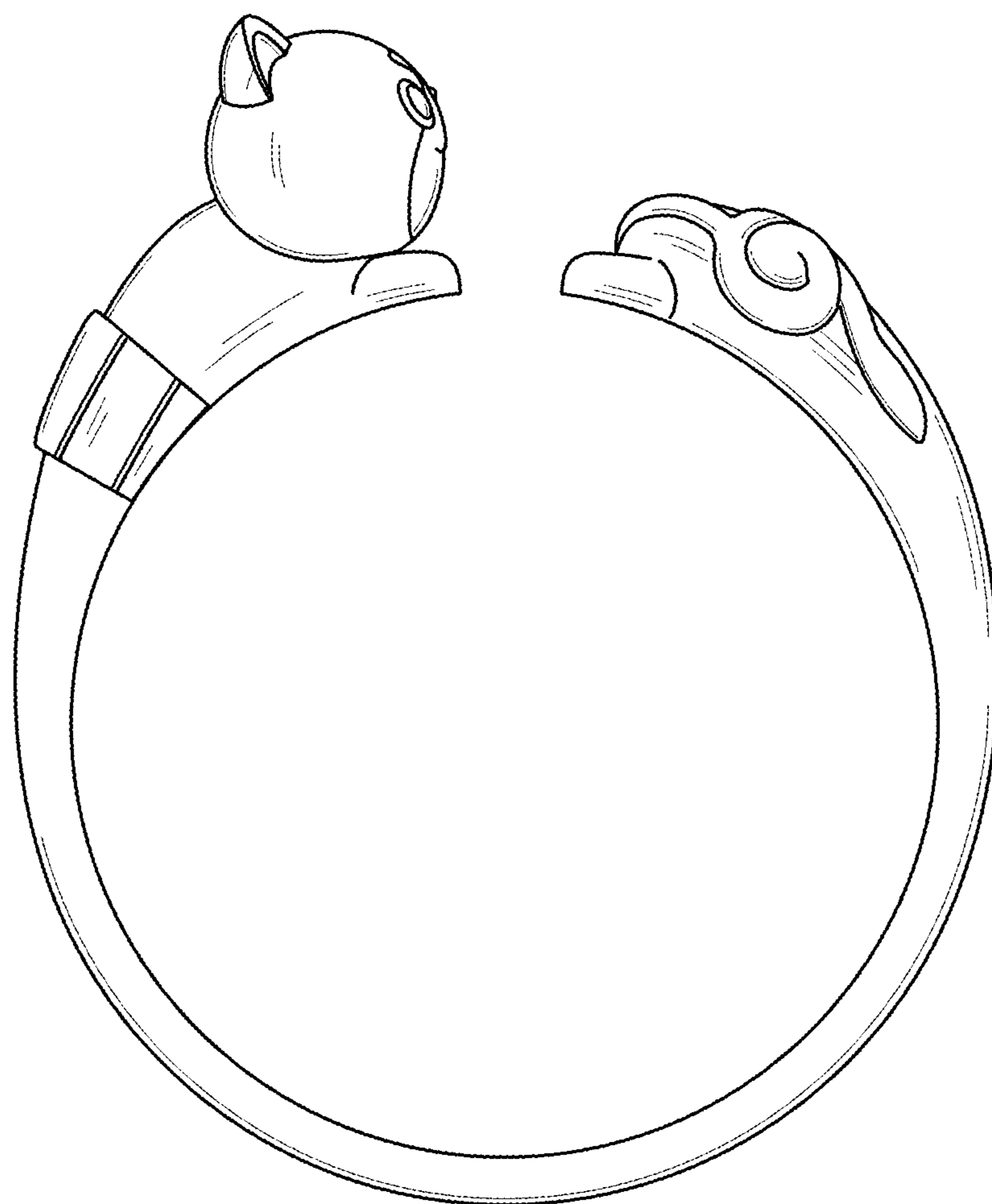

FIG. 5

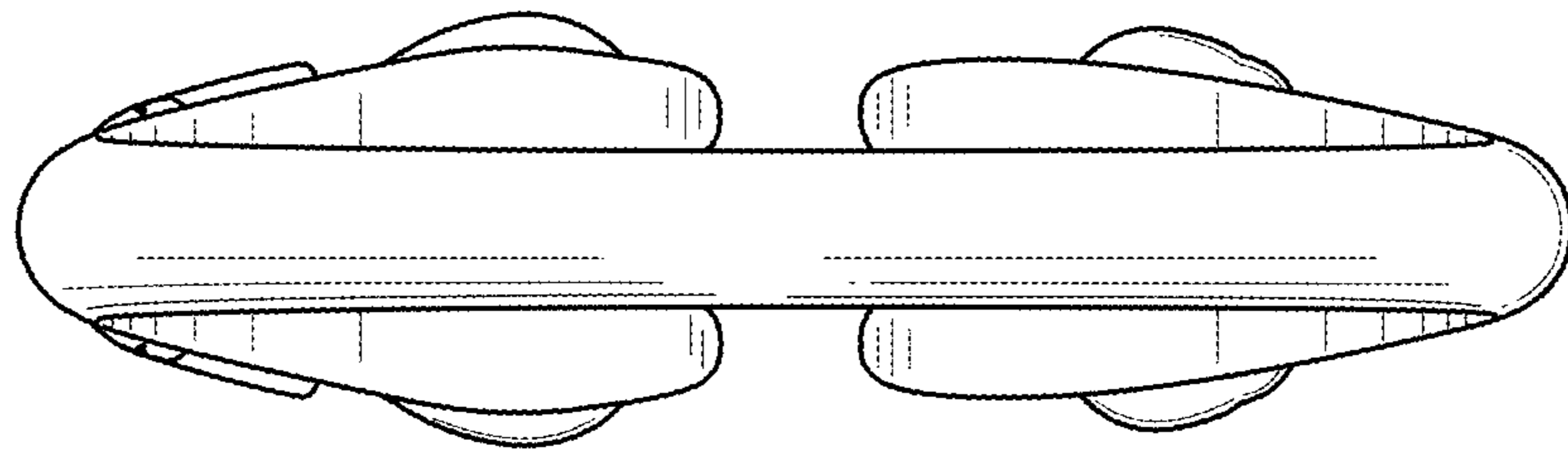

FIG. 6

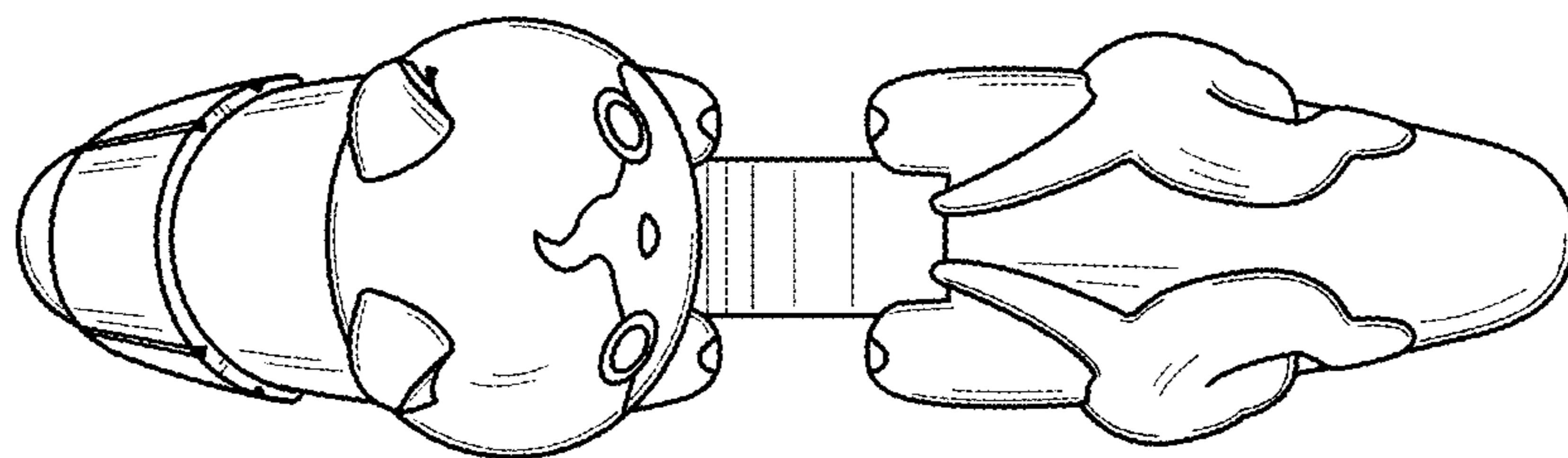

FIG. 7