



US00D784791S

(12) **United States Design Patent** (10) **Patent No.:** **US D784,791 S**  
**Aragaw** (45) **Date of Patent:** **\*\* Apr. 25, 2017**

(54) **WALL PLATE**  
(71) Applicant: **Getachew K. Aragaw**, Toronto (CA)  
(72) Inventor: **Getachew K. Aragaw**, Toronto (CA)  
(\*\*) Term: **15 Years**  
(21) Appl. No.: **29/554,271**  
(22) Filed: **Feb. 10, 2016**  
(51) **LOC (10) Cl.** ..... **11-05**  
(52) **U.S. Cl.**  
USPC ..... **D8/353**  
(58) **Field of Classification Search**  
USPC ..... D8/330, 331, 334, 300, 301, 302,  
D8/350-353; 70/14, 20-22, 57, 57.1,  
70/284-286, 314, DIG. 44; 340/5.21,  
340/5.54, 5.65, 5.73, 5.81, 5.85  
CPC . E05C 9/004; E05B 9/002; E05B 9/00; E05B  
9/02; E05B 37/00; E05B 1/00; E05B  
3/00; E05B 47/00; E05B 47/06; E05B  
49/00; E05B 15/02; E05B 15/00; E05B  
13/103; Y10T 70/8324; Y10T 70/8459;  
Y10T 70/8514; Y10T 70/8568  
See application file for complete search history.

D517,899 S \* 3/2006 Pan ..... D8/353  
D536,237 S \* 2/2007 Smith ..... D8/353  
D548,572 S \* 8/2007 DeCosta ..... D8/353  
D559,656 S \* 1/2008 DeCosta ..... D8/353  
D566,525 S \* 4/2008 DeCosta ..... D8/353  
D703,083 S \* 4/2014 Saikawa ..... D10/121  
D755,606 S \* 5/2016 Eaton ..... D8/353  
D756,748 S \* 5/2016 Lu ..... D8/331  
D756,749 S \* 5/2016 Lu ..... D8/331  
D772,695 S \* 11/2016 Burge ..... D8/353  
D772,696 S \* 11/2016 Burge ..... D8/353

\* cited by examiner

*Primary Examiner* — Mark Goodwin

(56) **References Cited**  
U.S. PATENT DOCUMENTS

D173,629 S \* 12/1954 Schlage ..... D26/151  
D283,221 S \* 4/1986 West ..... 174/67  
4,691,974 A \* 9/1987 Pinkerton ..... H01R 13/447  
439/147  
D308,626 S \* 6/1990 Villarreal ..... D13/154  
D365,747 S \* 1/1996 Grande ..... D8/353

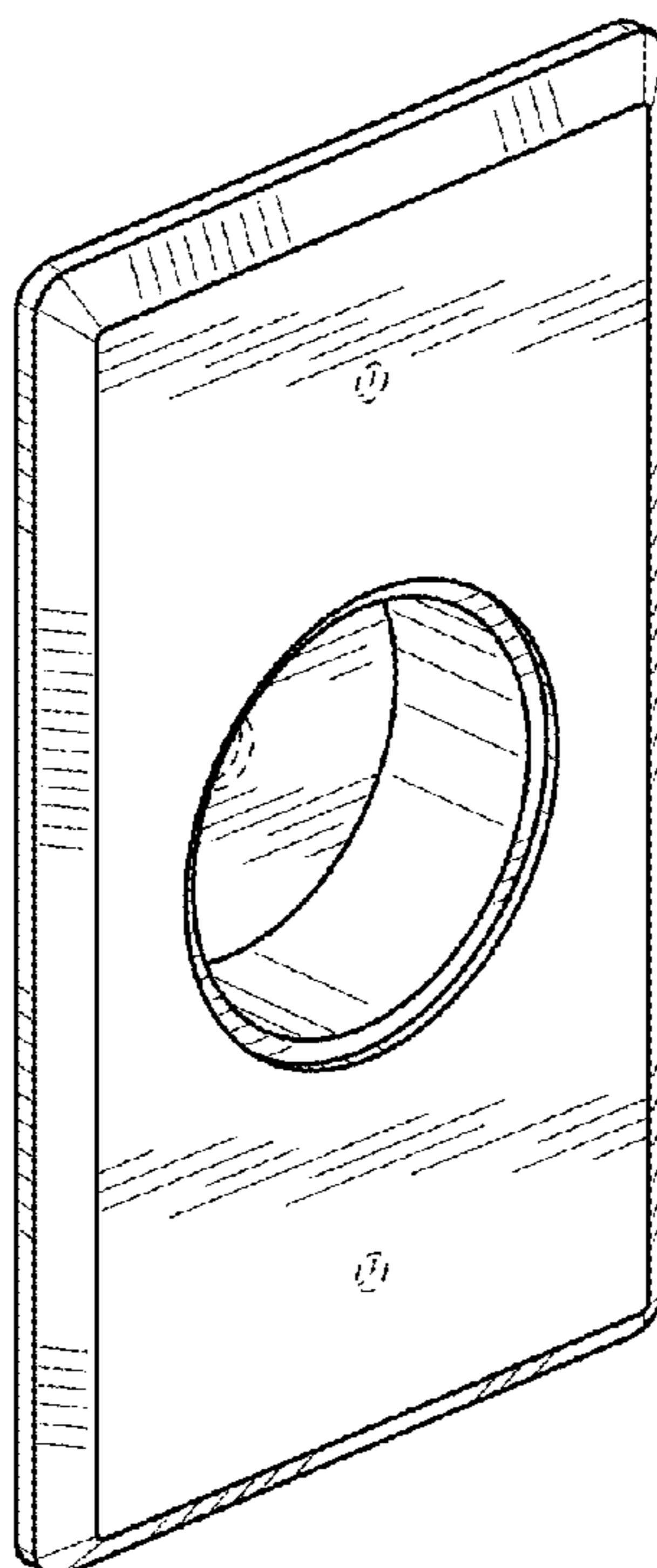
(57) **CLAIM**

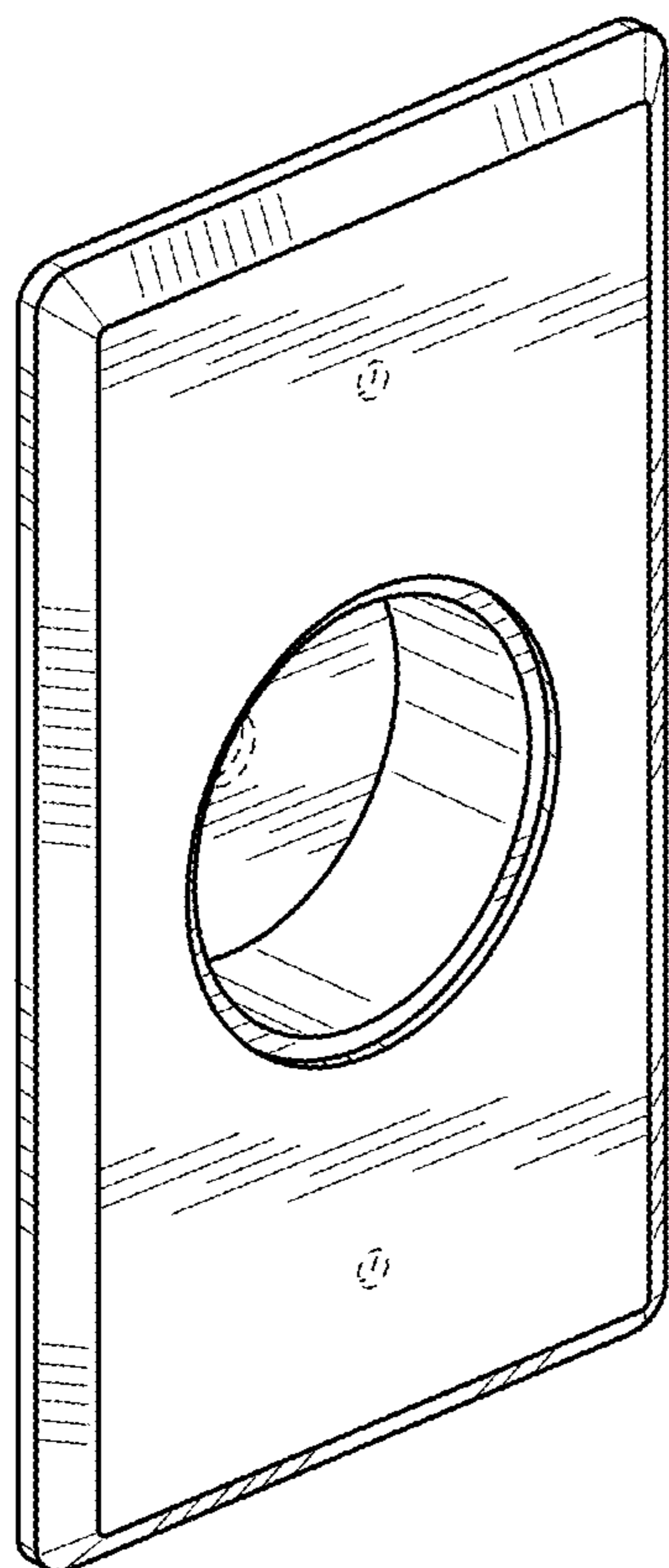
The ornamental design for a wall plate, as shown and described herein.

**DESCRIPTION**

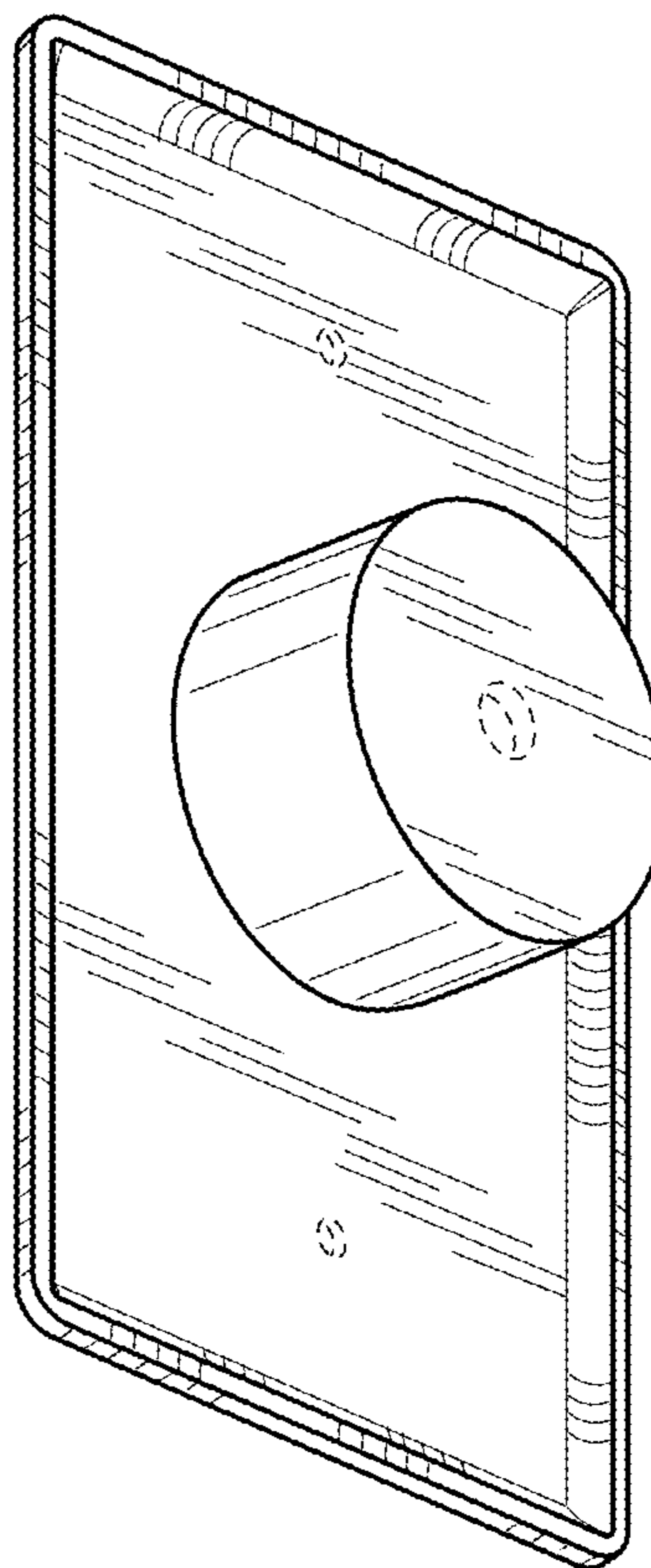
FIG. 1 is a front perspective view of a wall plate embodying the claimed design;  
FIG. 2 is a rear perspective view thereof;  
FIG. 3 is a left side view thereof, the right side view being a mirror image;  
FIG. 4 is a front view thereof;  
FIG. 5 is a rear view thereof; and,  
FIG. 6 is a top view thereof, the bottom view being a mirror image.  
The features shown in broken lines do not form part of the claimed design.

**1 Claim, 2 Drawing Sheets**

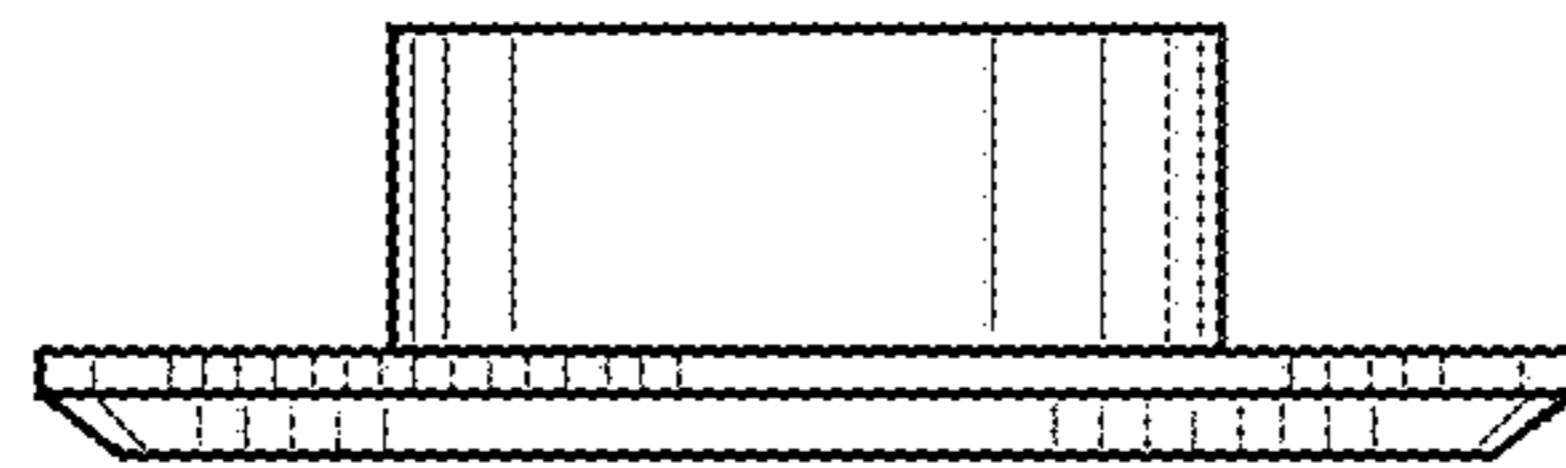




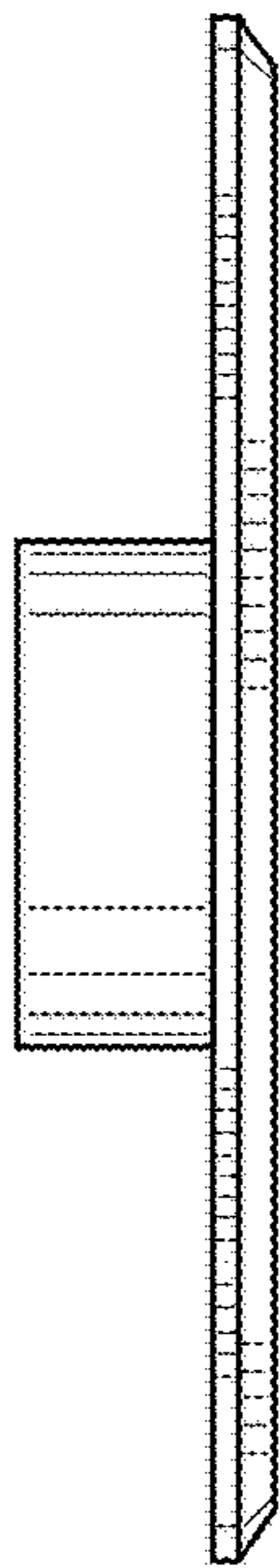
**FIG. 1**



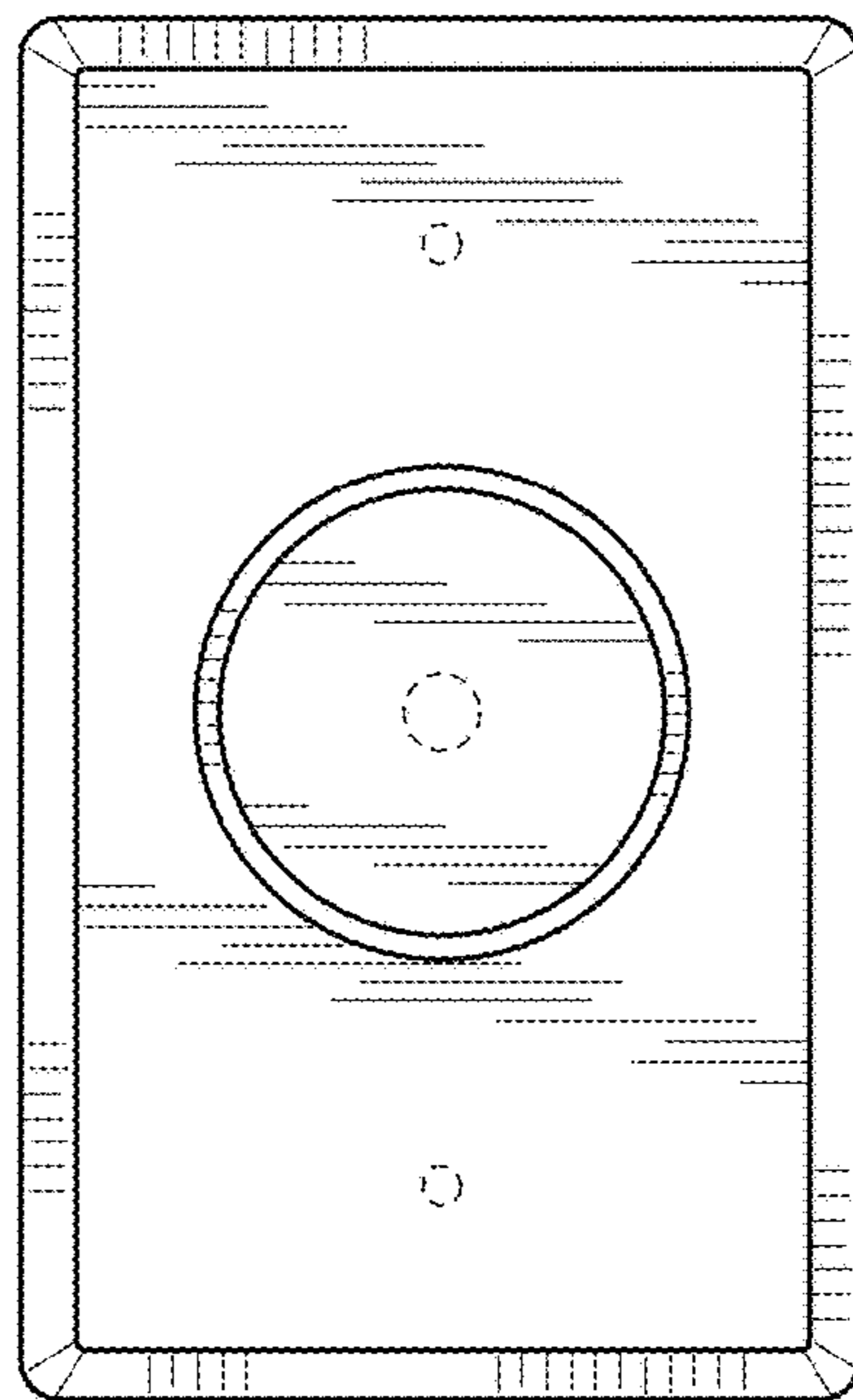
**FIG. 2**



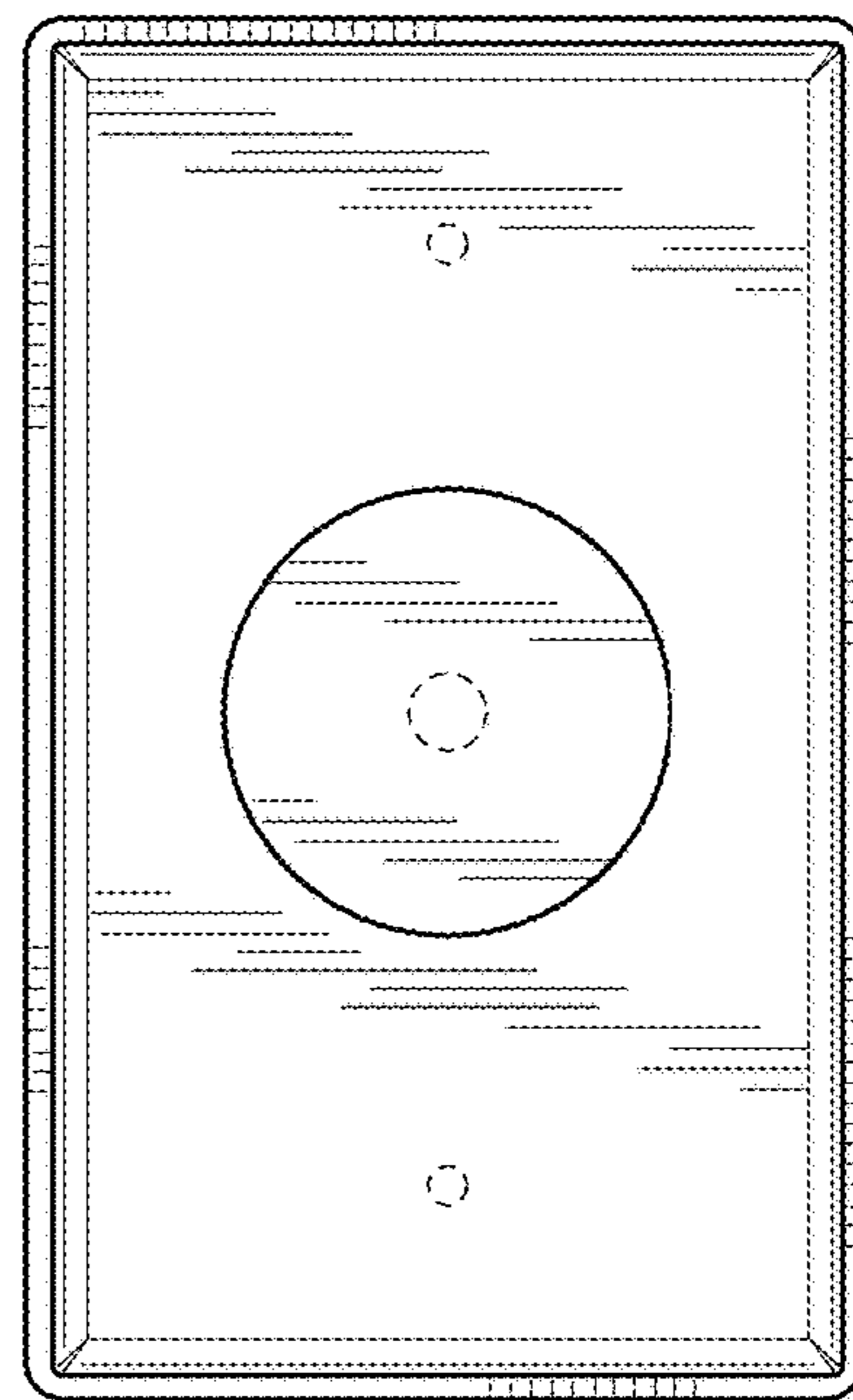
**FIG. 6**



**FIG. 3**



**FIG. 4**



**FIG. 5**